

Original operating instructions
Photoelectric safety sensors
(safety light curtain)
for finger protection
(resolution / detection capacity 14 mm)

UK

OY

11510703 / 00 01 / 2023

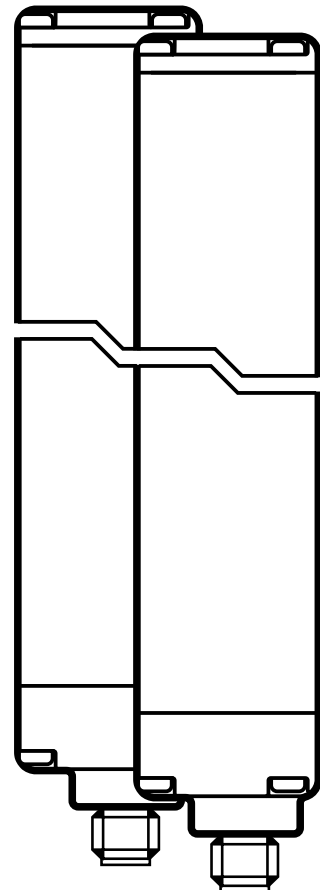

Contents

1	Preliminary note.....	4
1.1	Symbols used	4
1.2	Warning signs used	4
2	Safety instructions	5
2.1	Safety-related requirements regarding the application.....	6
3	Items supplied.....	7
4	Functions and features	7
5	Function	8
6	Installation.....	9
6.1	Installation instructions	9
6.2	Calculation of the minimum safety distance	10
6.3	Vertical installation of the safety light curtains	12
6.3.1	Safety light curtains resolution 14 mm.....	12
6.4	Fixing and optical alignment	13
6.4.1	Optical alignment.....	14
6.5	Distance of the reflecting surfaces	15
6.6	Multiple systems	17
6.7	Use of corner mirrors.....	18
7	Electrical connection.....	19
7.1	Wiring diagram transmitter.....	19
7.2	Wiring diagram receiver.....	20
8	Operating modes	21
8.1	Automatic operation	22
8.2	Manual operation	22
8.3	Connection of external contactors	23
8.4	Test function.....	23
8.4.1	Internal test function	23
9	Operating and display elements	23
9.1	LED states	24
10	Operation.....	24
10.1	Switching state of the outputs.....	24
10.1.1	The safe state.....	25

10.1.2	The switched state.....	25
10.1.3	Interface classification	25
10.2	Functional test of the safety light curtains	26
11	Scale drawing	27
12	Technical data	28
12.1	Safety light curtains: 14 mm resolution.....	29
13	Troubleshooting	29
13.1	Fault diagnosis transmitter	29
13.2	Fault diagnosis receiver.....	30
14	Maintenance, repair and disposal.....	31
15	Terms and abbreviations.....	32
16	Annex.....	33
16.1	Check list.....	33

1 Preliminary note

The instructions are part of the unit. They are intended for authorised persons according to the EMC and low voltage directives and safety regulations.

The instructions contain information about the correct handling of the product. Read the instructions before use to familiarise yourself with operating conditions, installation and operation.

Adhere to the safety instructions.

1.1 Symbols used

▶ Instruction

> Reaction, result

→ Cross-reference

○ LED off

● LED on

⊗ LED flashes



Important note:

Non-respect can result in malfunctions or interference.



Information

Supplementary note.



Access prevention finger protection

1.2 Warning signs used

WARNING

Warning of serious personal injury.

Death or serious irreversible injuries may result.

2 Safety instructions

- Follow the operating instructions.
- In case of non-observance of notes or standards, specially when tampering with and/or modifying the unit, any liability and warranty is excluded.
- The unit must be installed, connected and put into operation by a qualified electrician trained in safety technology.
- The applicable technical standards for the corresponding application must be complied with.
- For the installation the standards EN 60204, EN 999 and ISO 13855 have to be observed.
- In case of malfunction of the unit please contact the manufacturer. Tampering with the unit is not allowed.
- Disconnect the unit externally before handling it. Disconnect all relay load circuits that are supplied independently.
- After setup the system has to be subjected to a complete function check.
- Only use the unit under the specified operating conditions (→ 12 Technical data). In case of special operating conditions please contact the manufacturer.
- In case of any questions concerning safety - if required - contact the safety expert in charge of your country.

WARNING

In case of improper handling of the product, the safety and physical integrity of operators and machinery cannot be guaranteed.

Death or serious irreversible injuries may result.

- ▶ Observe all notes on installation and handling in these instructions.
- ▶ The photoelectric safety sensors must only be used under the specified operating conditions and in accordance with use as prescribed below.

2.1 Safety-related requirements regarding the application

It must be ensured that the safety requirements of the respective application correspond to the requirements stated in these instructions.

Observe the following requirements:

- ▶ Adhere to the specified operating conditions (→ 12 Technical data). Use of the photoelectric safety sensors in the vicinity of chemically and biologically active media as well as ionising radiation is not permitted.
- ▶ For applications in the food industry contact your ifm branch office to check the compatibility of the materials of the photoelectric safety sensors with the chemicals used.
- ▶ Adhere to the principle of normally closed operation for all external safety circuits connected to the system.
- ▶ If the photoelectric safety sensors go into the state defined as safe due to an internal fault, measures have to be taken to maintain the safe state when the installation resumes operation.
- ▶ Replace damaged units.

The protective function of the photoelectric safety sensors is only ensured with the following conditions:

- The machine control can be electrically controlled and the hazardous machine motion can be stopped immediately at any time of the operation cycle.
- There is no danger for machine operators due to ejection of materials or machine parts.
- The hazardous area is only accessible via the protected area.

3 Items supplied

- 2 photoelectric safety sensors (1 transmitter and 1 receiver)
- up to a total length of 1263 mm: 4 angle brackets, 4 slot nuts with M5 thread and suitable nuts
- starting with 1263 mm total length: 6 angle brackets, 6 slot nuts with M5 thread and suitable nuts
- 1 copy operating instructions photoelectric safety sensors, reference no. 704701.

If one of the above-mentioned components is missing or damaged, please contact one of the ifm branch offices. **UK**

4 Functions and features

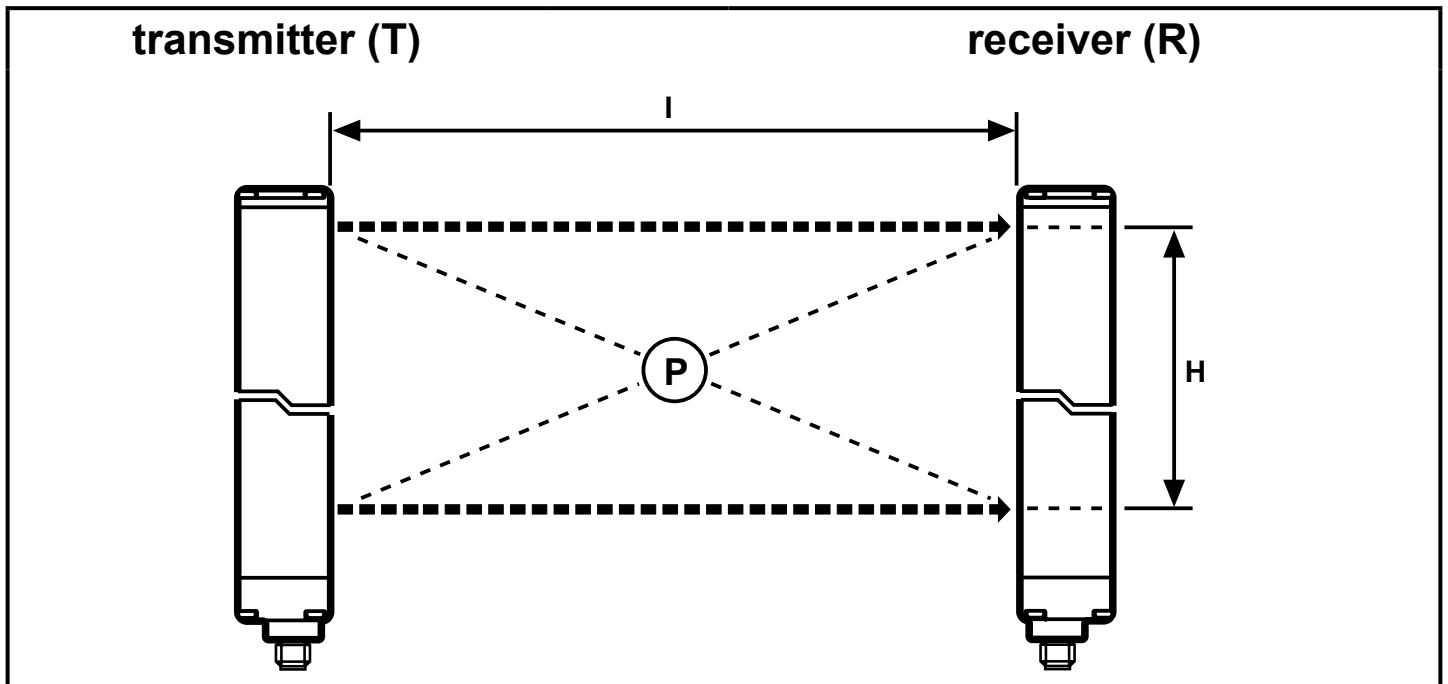

P = protected area; I = protected area width (range) H = protected area height

The OY safety light curtains are multi-beam optoelectronic safety devices to IEC 61496 and consist of one transmitter and one receiver.

5 Function

The protected area (P) is generated between the transmitter and the receiver and is defined by the protected area height (H) and the protected area width (range) (l).

The protected area height is the height protected by the safety light curtain. It depends on the design (→ 12 Technical data).

If the safety light curtains are installed horizontally, this value indicates the depth of the protected area.

The protected area width (range) is the maximum distance between transmitter and receiver (→ 12 Technical data).

If the protected area is clear, the two outputs (OSSDs) of the receiver are active.

If an object (O) with a diameter greater than or equal to the resolution (d) enters the protected area, the outputs are switched off.

The resolution (d) (detection capability) of the safety light curtain depends on the lens diameter (B) and the lens distance (C) and remains constant at all application conditions.

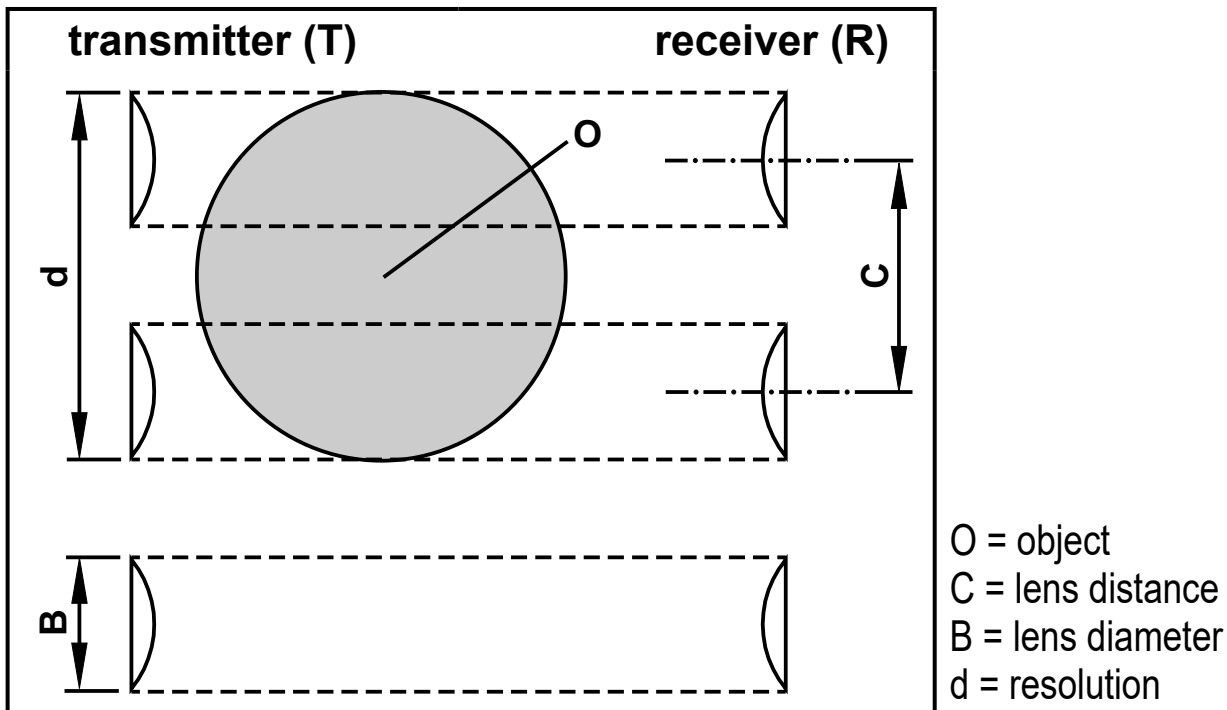

To ensure that an object (O) is reliably detected in the protected area the dimensions of the object (O) must be at least as great as the resolution (d).

6 Installation

6.1 Installation instructions

The following conditions are to be ensured before installation of the photoelectric safety sensors:

- The degree of protection of the electro-sensitive equipment (ESPE) has to correspond with the risk assessment of the machine to be monitored.
- The safety system ensures a safety function and is not required for the operation of a machine.
- It must be possible to stop any hazardous motion of the machine immediately. In this respect the shutdown delay of the machine has to be determined.
- The object to be detected must be greater than or equal to the resolution of the photoelectric safety sensor.



Install the photoelectric safety sensors so that the hazardous area can only be accessed via the protected area. Depending on the application other mechanical protective equipment may be necessary.

The operating conditions at the mounting location must not affect the functioning of the photoelectric safety sensors. Please note especially:

- The transmitter and the receiver must not be affected by intensive light sources (emitters, sunlight etc.).
- The operating temperature must be within the range indicated (→ 12 Technical data).
- Fogging of the lenses due to considerable temperature fluctuations can affect the functioning of the photoelectric safety sensors. Take appropriate measures to prevent this.
- Certain operating conditions can affect the functioning of the photoelectric safety sensors. For mounting locations where fog, rain, smoke or dust may occur, it is recommended to take appropriate measures.
- The standards EN 999 and ISO 13855 must be adhered to.



Observe the following illustrations for correct installation of the photoelectric safety sensors.

Correct installation

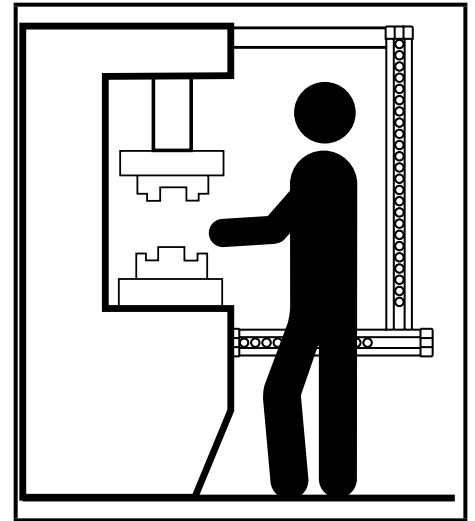
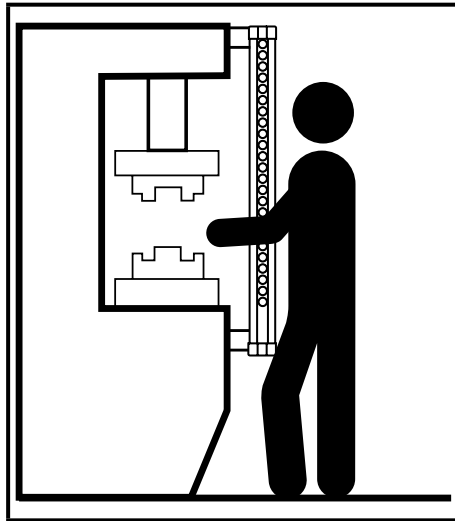
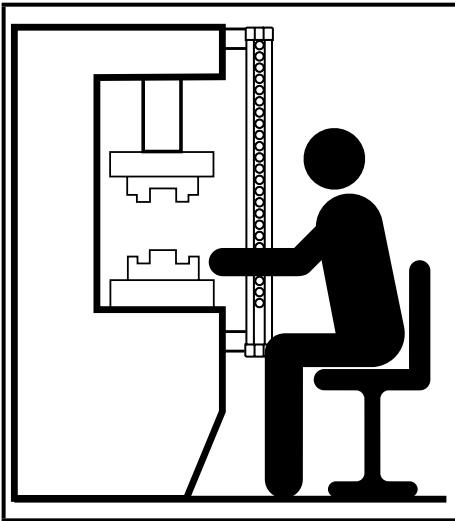

Wrong installation

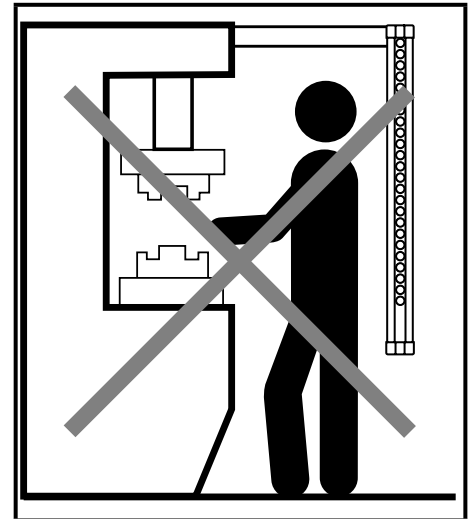
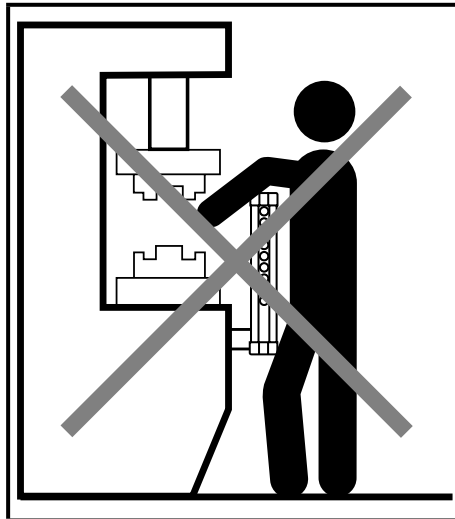
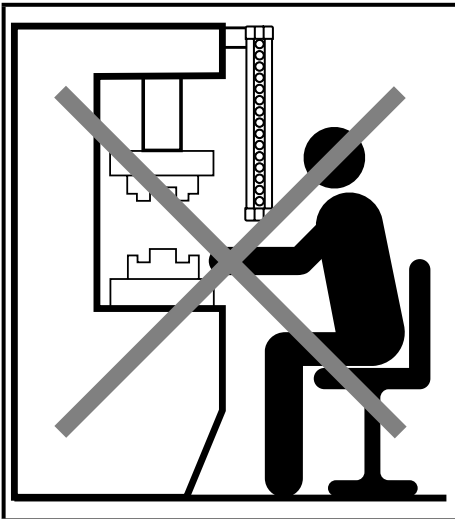

6.2 Calculation of the minimum safety distance

There must be minimum safety distance between the photoelectric safety sensor and the point of danger. This distance must be ensured so that the point of danger cannot be accessed before the hazardous state of the machine has been stopped.

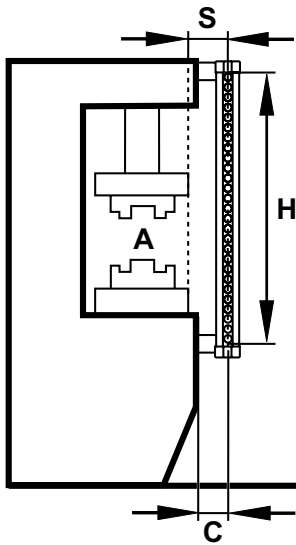

- ▶ Install the photoelectric safety sensor at a distance that is greater or equal to the minimum safety distance (S) so that the hazardous area (A) can only be accessed after complete standstill of the hazardous machine motion.

According to the European Standard EN 999:2008 the following formula is to be used to calculate the minimum safety distance (S):

$$S = K (t_1 + t_2) + C$$

$$C = 8 (d - 14)$$

A = hazardous area
H = protected area height

S = min. safety distance
C = additional distance

UK

S	Minimum safety distance	mm
K	Speed of approach of the object towards the hazardous area	mm/s
t₁	Total response time of the protective equipment, from release to switching off	s
t₂	Total response time of the machine, from the stop signal to switching off or to passing into the state defined as safe	s
C	Additional distance	mm
d	Resolution (detection capability)	mm



Non-compliance with the minimum safety distance may lead to restrictions to or loss of the safety function.

Application example:

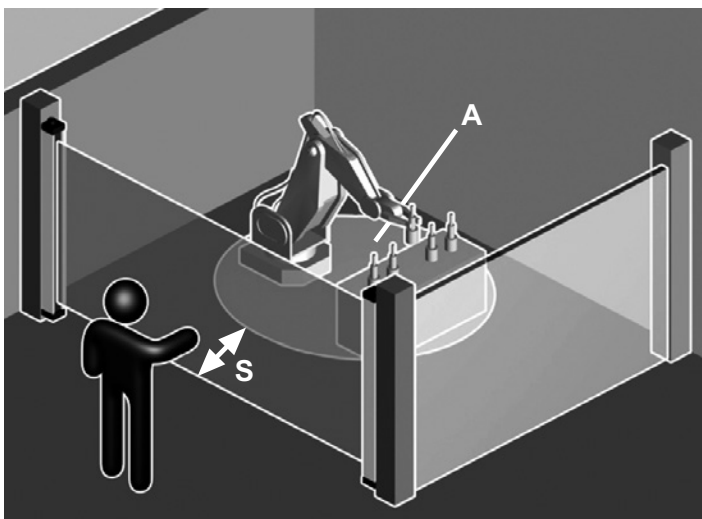

A = hazardous area
S = min. safety distance

6.3 Vertical installation of the safety light curtains

6.3.1 Safety light curtains resolution 14 mm



These designs are suitable for access prevention of fingers (finger protection).

The minimum safety distance (S) is determined using the following formula:

$$S = 2000 (t_1 + t_2) + 8 (d - 14)$$

This formula applies to minimum safety distances (S) between 100 and 500 mm.

The min. safety distance (S) must be > 100 mm.

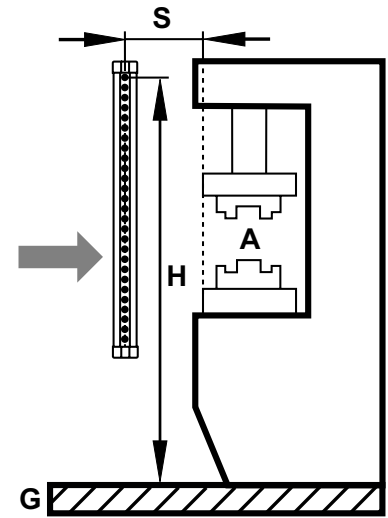

A = hazardous area

H = height

S = min. safety distance

G = reference level

If due to the special configuration of the machine it should be possible to reach the hazardous area from above, the highest light beam of the safety light curtain should be at a height (H) (measured from the reference level (G)) whose value is determined to the specifications in ISO 13855.

6.4 Fixing and optical alignment



Correct alignment of the transmitter and the receiver is decisive for the proper function of the photoelectric safety sensors.

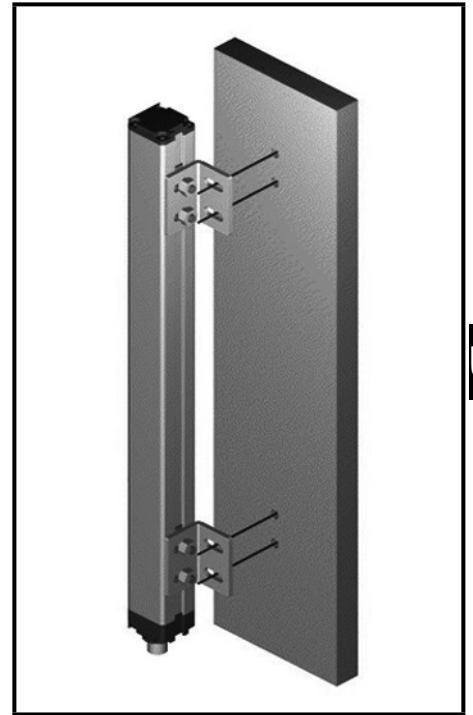
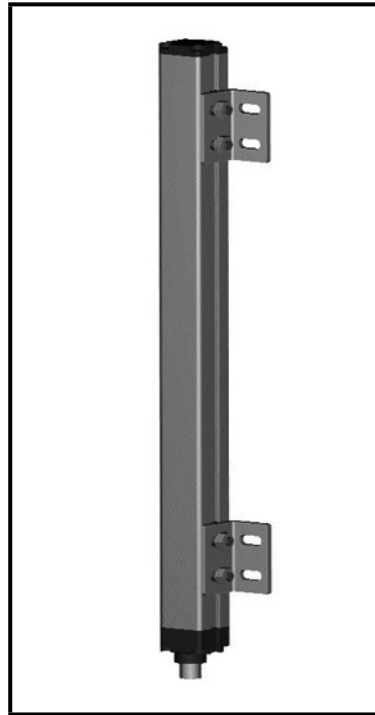
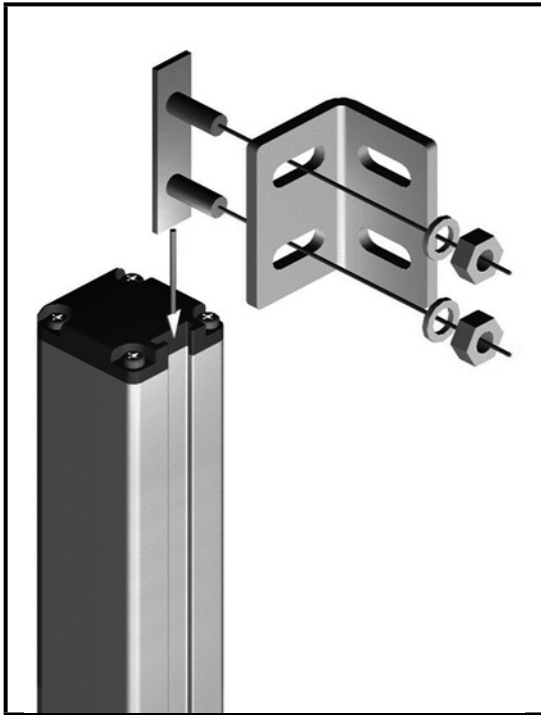

- ▶ Install the transmitter and the receiver using the supplied mounting accessories so that they are exactly opposite each other.
- ▶ Align the transmitter and the receiver so that they are in parallel at the same height and the plugs face the same direction.



If vibrations are to be expected in your applications, it is recommended to use vibration dampers (available as accessory).



Adjustable brackets can be used to ensure easy optical alignment (available as accessories).

6.4.1 Optical alignment

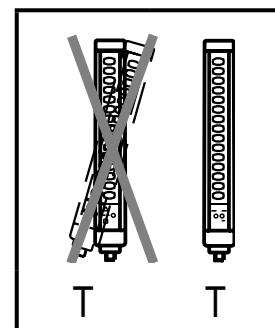
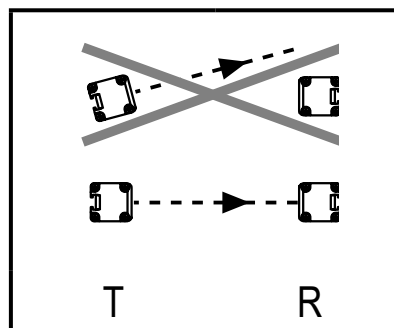
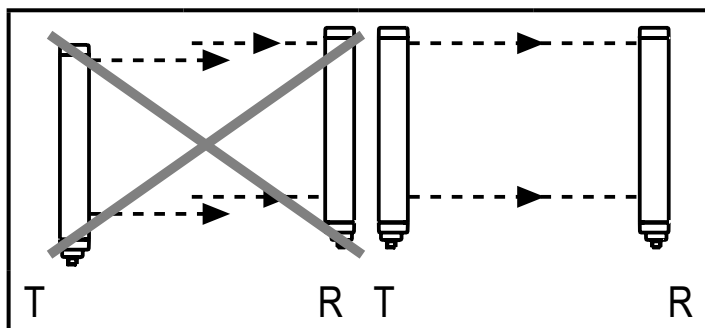

T = transmitter; R = receiver

The indication LEDs of the receiver help to correctly align the photoelectric safety sensors.

Description	Receiver			
	2-colour LED red	2-colour LED green	2-colour LED yellow	2-colour LED blue
Receiver does not detect any light beams	●	○	○	○
Receiver detects some light beams	⊗	○	○	●
Receiver detects all light beams with a weak signal	○	●	○	●
Receiver detects all light beams	○	●	○	○

- ▶ Align the transmitter so that the green LED of the receiver lights.
- ▶ Fix the transmitter and the receiver.

6.5 Distance of the reflecting surfaces



Reflective surfaces close to photoelectric safety sensors can disable the safety function of the system.

The minimum distance (D) depends on the protective area width (I) taking into consideration the projection and receiving angles.



The minimum distance (D) between reflective surfaces and the protected area (P) must be observed. In case of non-respect an object to be detected may not be detected. In case of improper handling of the product, the safety and physical integrity of operators and machinery cannot be guaranteed.

UK

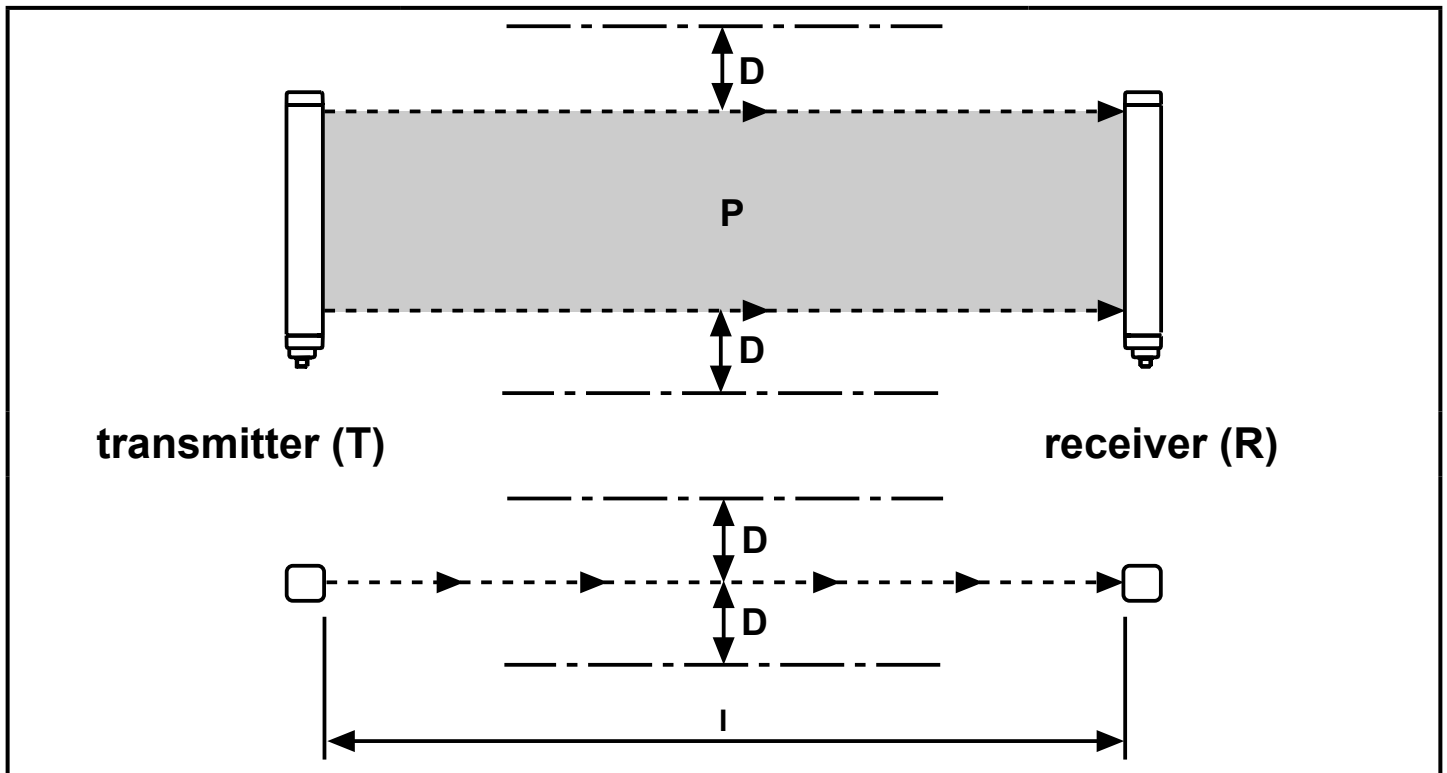

D = minimum distance; I = protected area width (range); P = protected area

- After installation test by intended interruption of the protected area (P) if reflective surfaces affect the function of the photoelectric safety sensors.

Minimum distance to reflective surfaces

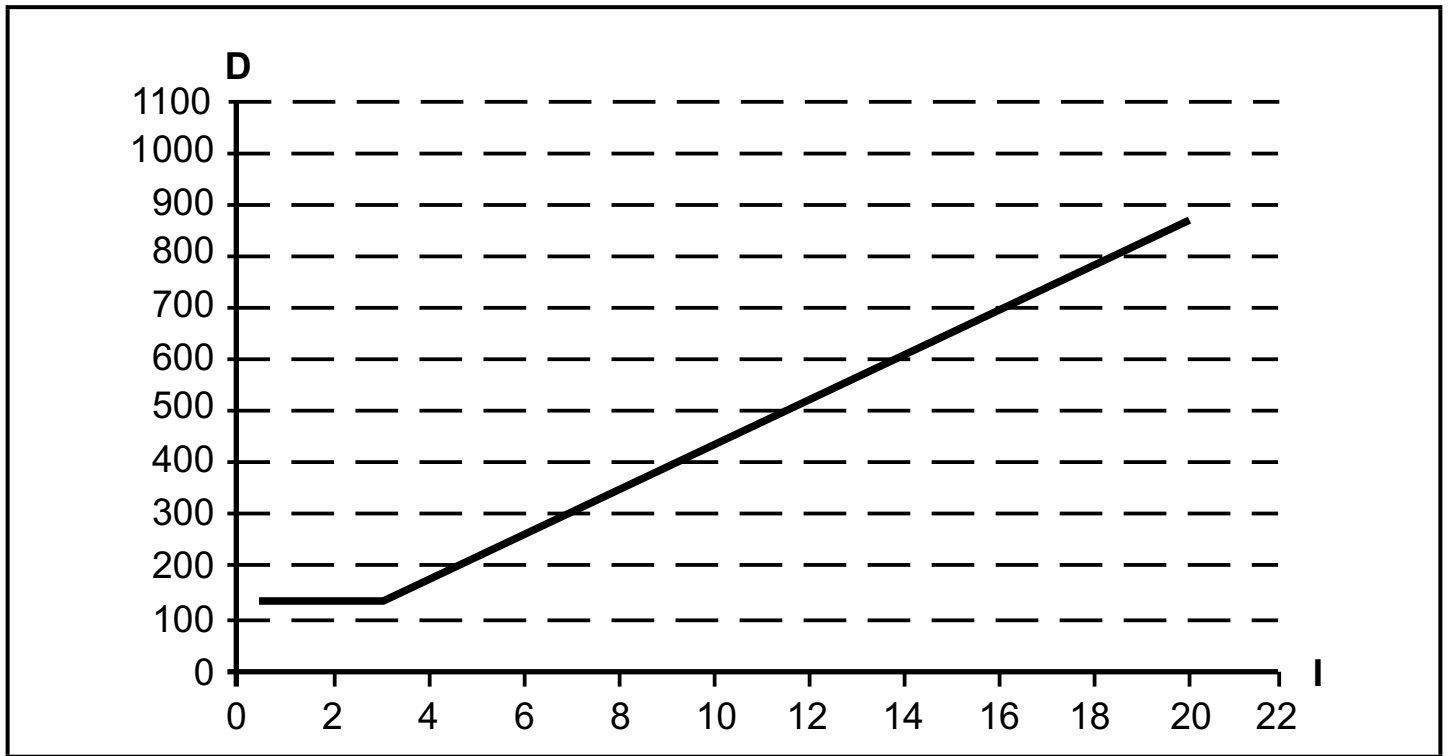

D = minimum distance in [mm]; I = protected area width (range) [m]

6.6 Multiple systems



The use of several safety light curtains can lead to malfunction and disable the protective function.

The safety light curtains are to be installed so that the beam sent by the transmitter of a system can only be detected by the respective receiver.

The following important rules for installation are to be observed to avoid mutual interference of several systems:

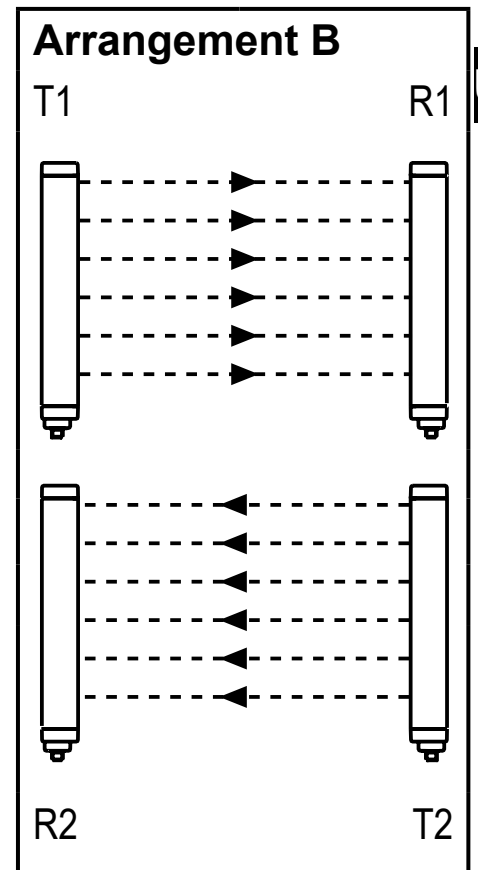
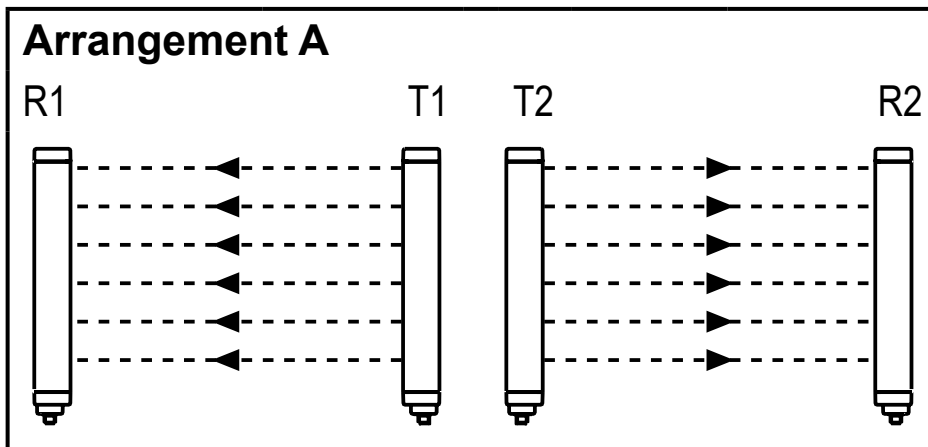

UK

Possible arrangements:

A: Position of both transmitters next to each other

B: Position transmitter 1 and receiver 2 on top of each other

C: Combination in "L" shape

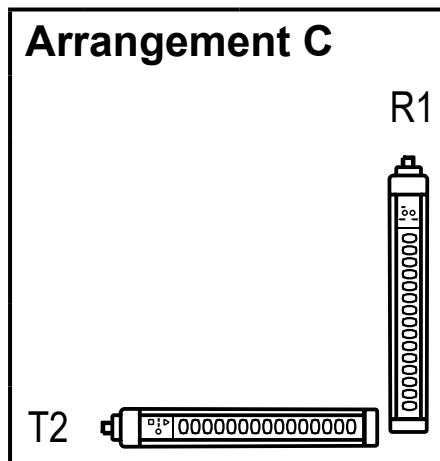

T = transmitter; R = receiver

6.7 Use of corner mirrors

To protect and monitor hazardous areas with access from several sides one or several mirrors can be used (available as accessory). By using mirrors the light beam emitted by the transmitter can be sent via several access sides.

- ▶ To obtain a reflection angle of 90° the mirrors are to be oriented in an angle of inclination of 45° .

The following image shows an application where U-shaped access protection is implemented using two mirrors.

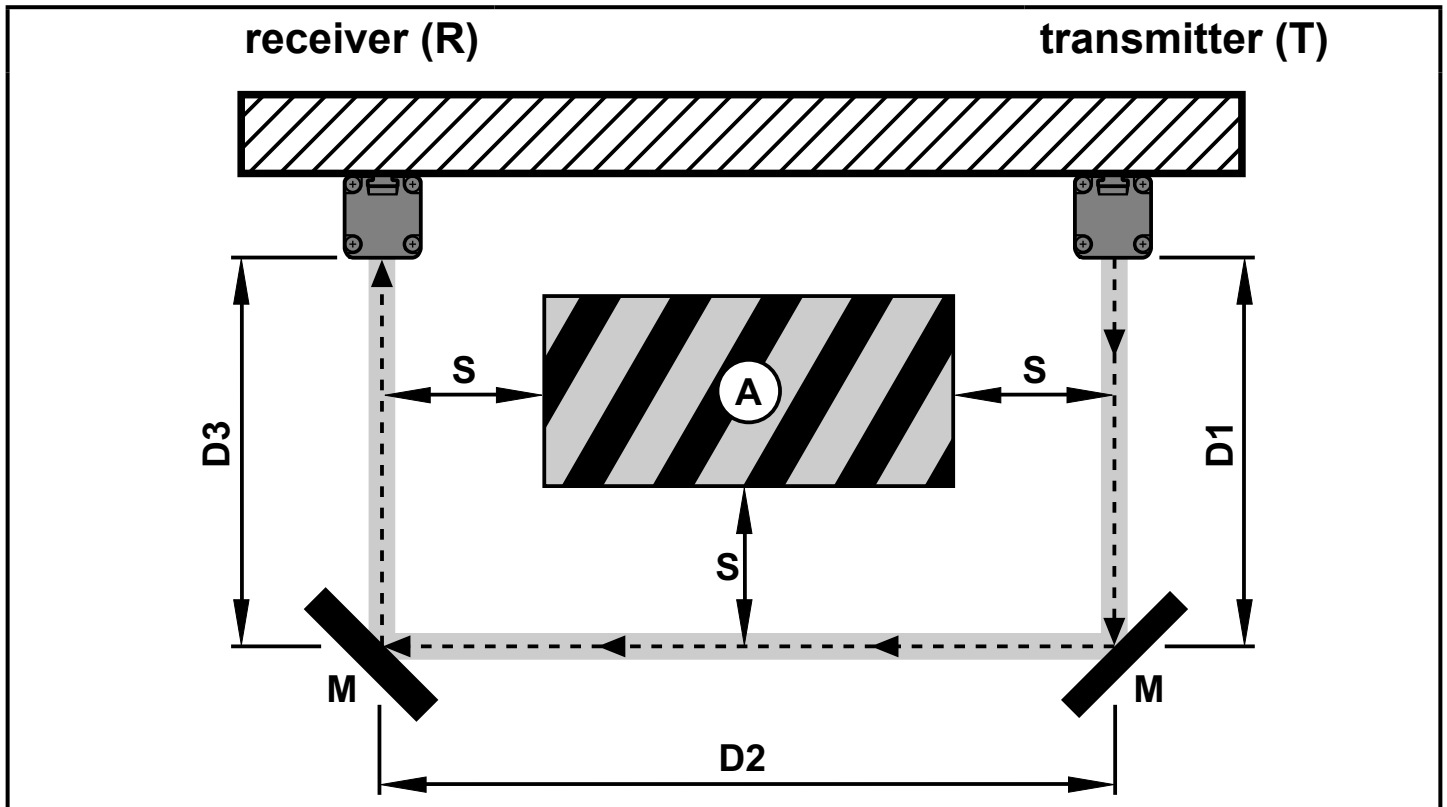

A = hazardous area
M = corner mirror

S = min. safety distance
Dx = side length

- ▶ Install the mirrors so that the minimum safety distance (S) is adhered to at each side of the hazardous area.
- ▶ During installation make sure that the reflecting area is plane and that no vibrations affect the safety device.
- The range is the sum of the length of all sides ($D1 + D2 + D3$) of the access to the protected area. The maximum range of the photoelectric safety sensors is reduced by 15% for each mirror.
- Do not use more than three mirrors.

7 Electrical connection

► Disconnect power. Also disconnect any independently supplied relay load circuits.

 The nominal voltage is 24 V DC. This voltage may vary between 19.2 V and 28.8 V.

 In case of a single fault the supply voltage must not exceed a maximum of 28.8 V DC. Therefore a safe separation between current supply and transformer is necessary.

 To guarantee functional reliability an output capacity of min. 2000 $\mu\text{F} / \text{A}$ has to be ensured if a power supply with diode bridge is used.

UK

► Connect the devices to the following table:

7.1 Wiring diagram transmitter

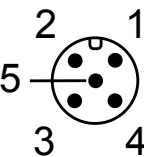
Pin layout	Pin	Name	Type	Description
	1	L+ (24 V DC)	Input	Operating voltage
	2	Range 0		Configuration protected area width
	3	L- (0 V DC)		Operating voltage
	4	Range 1		Configuration protected area width
	5	FE		Functional earth

For information about available sockets/connectors see:

www.ifm.com → Products → Accessories

The protected area width (range) to be used is configured via range 0 and range 1.

Configuration protected area width (range)

Range 0	Range 1	Description
24 V	0 V	Selection range low (0...3 m)
0 V	24 V	Selection range high (1...6 m)
0 V	0 V	Transmitter in test function (→ 8.4 Test function)
24 V	24 V	No function, configuration error

 For proper function of the safety light curtains pins 2 and 4 of the transmitter have to be connected according to the indications in the above table.

7.2 Wiring diagram receiver

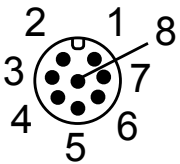
Pin layout	Pin	Name	Type	Description
	1	OSSD1	Output	Static safety output 1
	2	24 V DC	–	Operating voltage 24 V DC
	3	OSSD2	Output	Static safety output 2
	4	K1_K2 /restart	Input	External feedback contact
	5	SEL_A	Input	Operating mode Safety light curtains
	6	SEL_B	Input	
	7	0 V DC	–	Operating voltage 0 V DC
	8	FE	–	Functional earth

For information about available sockets/connectors see:

www.ifm.com → Products → Accessories



Note: Lay the cables of the photoelectric safety sensors separately from sources of interference such as power lines.

► Connect the transmitter and the receiver to the functional earth.

8 Operating modes

The different operating modes of the safety light curtains of the OY series can be set via the respective connections to the 8-pole plug of the receiver.

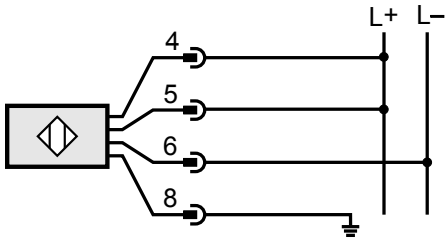
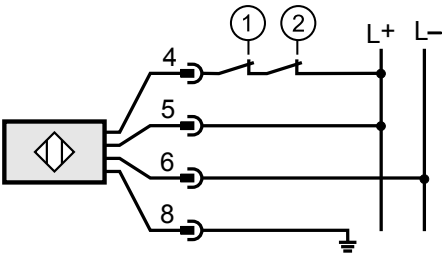
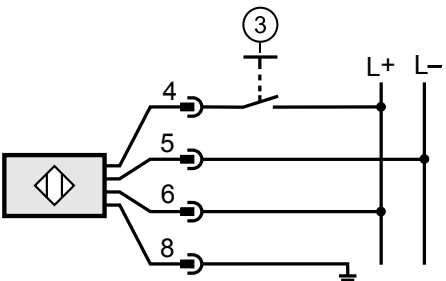
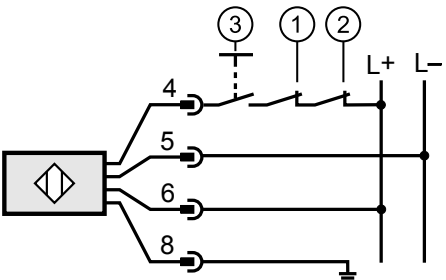
Operating modes	Connections		
	pin 4	pin 5	pin 6
A Automatic 	K1_K2 /restart Connects to: L+ (24 V DC)	SEL_A Connects to: L+ (24 V DC)	SEL_B Connects to: L- (0 V DC)
B Automatic with monitoring K1_K2 	K1_K2 /restart Connects to: L+ (24 V DC) (via NC contacts of K1_K2)	SEL_A Connects to: L+ (24 V DC)	SEL_B Connects to: L- (0 V DC)
C Manual 	K1_K2 /restart Connects to: L+ (24 V DC) (via start button)	SEL_A Connects to: L- (0 V DC)	SEL_B Connects to: L+ (24 V DC)
D Manually with monitoring K1_K2 	K1_K2 /restart Connects to: L+ (24 V DC) (via start button and NC contacts of K1_K2)	SEL_A Connects to: L- (0 V DC)	SEL_B Connects to: L+ (24 V DC)

- 1: K1
- 2: K2
- 3: Restart

UK

8.1 Automatic operation

If the safety light curtains are used in the automatic mode, monitored start is not possible.

The safety light curtains automatically return to operation with clear protected area, the outputs (OSSDs) are activated.



Verify if this is compatible with your machine.

In the automatic mode the OSSD1 and OSSD2 outputs follow the status of the safety light curtains:

Protected area clear	Outputs = active logic "1"
Protected area interrupted	Outputs = deactivated logic "0"

8.2 Manual operation

Operation in the manual mode (Start/Restart Interlock activated) is always necessary when passage to a hazardous area is to be monitored (persons can be present in the hazardous area after accessing the protected area without being detected).

The start/restart button has to be outside the hazardous area. It has to be installed so that the hazardous area and access can be clearly seen. It must not be possible to activate the start/restart button from within the hazardous area.



In the manual mode the safety light curtains comply with the function as "trip device" to IEC 61496. Non-compliance with this standard can lead to a hazard for people.

The OSSD1 and OSSD2 safety outputs are activated when the protected area is clear and the restart command is entered via a start button or via a respective pulse on input K1_K2/restart pin 4.

If the safety light curtains are released by a person or an object, a restart command (24 V on pin 4) has to be released. Pulse duration > 100 ms.

8.3 Connection of external contactors

External contactors can be integrated in the automatic or manual operating mode. The contactors have to be connected in series between the supply voltage and pin 4 of the receiver (→ 8 Operating modes / table, fig. B).

With manual function a start button has additionally to be switched in series (→ 8 Operating modes / table, fig. D).

8.4 Test function

For the test function the photoelectric safety sensors can e.g. be tested by a process control system or a control module (→ 7.1 Table Configuration protected area width).

The test pulse interrupts the light emission by the transmitter and the outputs carry a 0 signal (→ 10.1 Switching states of the outputs).



The minimum duration of the test command is 4 ms.

8.4.1 Internal test function

Type 4 safety light curtains continuously perform internal tests. The faults are detected within the response time of the respective model leading to switch-off (response times → 12 Technical data).

9 Operating and display elements

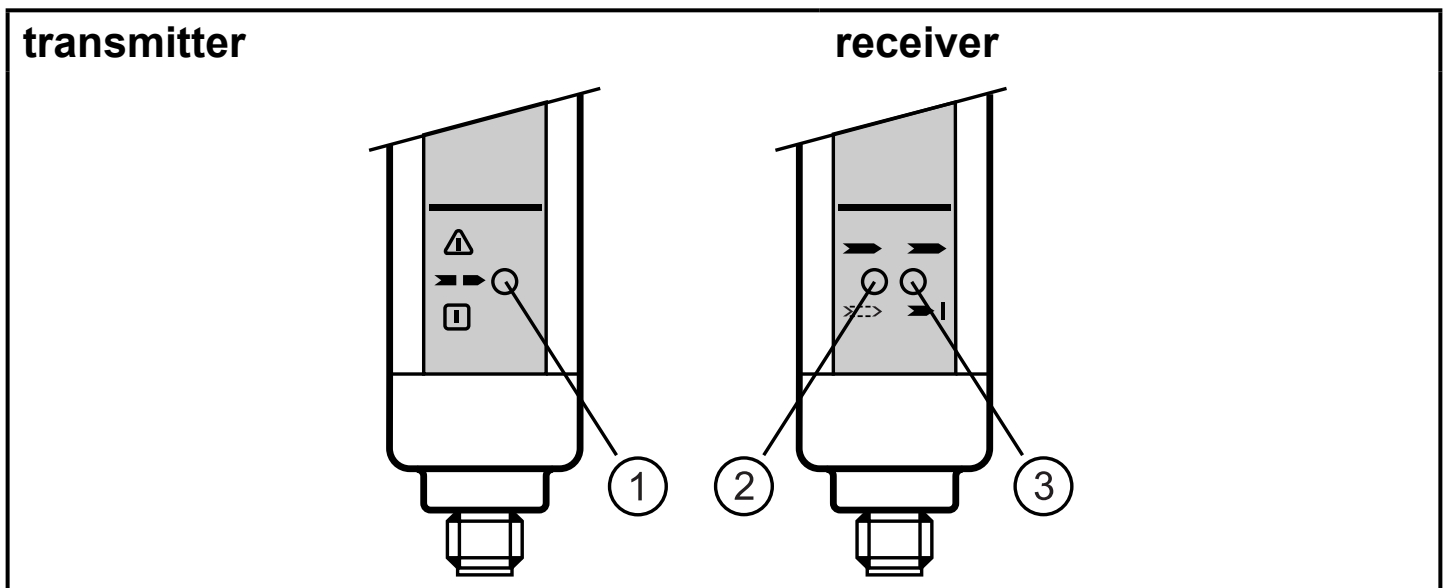

1: LED 3 colours (red/green/orange)

2: LED 2 colours (yellow/blue)

3: LED 2 colours (red/green)

9.1 LED states

The blue LED is lit when the signal is weak (→ 6.5.1 Optical alignment).

Description	transmitter			receiver			
	LED			LED		LED	
	red	green	orange	red	green	yellow	blue
Activating the system, input test	●	○	○	●	○	●	○
Fault (→ 13 Troubleshooting)	⊗	○	○	⊗	○	○	○
Test condition	○	○	●	○	○	○	○
Normal operating conditions	○	●	○	○	● *)	○	○
Protected area interrupted, outputs deactivated	○	●	○	●	○	○	○
Protected area clear, outputs deactivated, waiting for restart	○	●	○	○	○	●	○
Protected area clear, outputs activated	○	●	○	○	●	○	○

*) The green LED flashes twice when the system is switched on if the unit has been configured with a high range.

10 Operation

10.1 Switching state of the outputs

The safety light curtains have two outputs (OSSDs) on the receiver; the status depends on the condition of the protected area.

All short-circuits between the outputs or between an output and the current supply (24 V DC or 0 V DC) are detected by the 1 safety light curtains as a fault.

Output	Binary states			Description
OSSD1	1			Condition protected area clear.
OSSD2	1			
OSSD1	1	0	0	Condition protected area interrupted or fault detected.
OSSD2	0	1	0	

10.1.1 The safe state

The safe state is when the output is switched off (zero-current state: logic "0") of min. one of the outputs (OSSDs).

If one of the outputs is switched off, the subsequent safety-related logic unit must bring the complete system into the state defined as safe.

10.1.2 The switched state

In switched state the receiver provides a current of 24 V DC (logic "1") to both outputs.

Output characteristics

The output characteristics follow the characteristics of the input according to IEC 61496:

Logic "1"	24 V DC	max. 400 mA
Logic "0"	≤ 1.5 V DC	< 0.2 mA

10.1.3 Interface classification

The interface of the devices complies with interface type C class 3 according to the ZVEI position paper CB 24I Ed. 2.0

Identification key

	Interface type		Suitable interface type		
Source	C3	Receiver	C1	C2	C3

10.2 Functional test of the safety light curtains



Check the proper function of the safety light curtains before work starts.

For the functional test a test object in accordance with a resolution of the safety light curtains has to be used.

For information about available test rods see:

www.ifm.com → Products → Accessories.

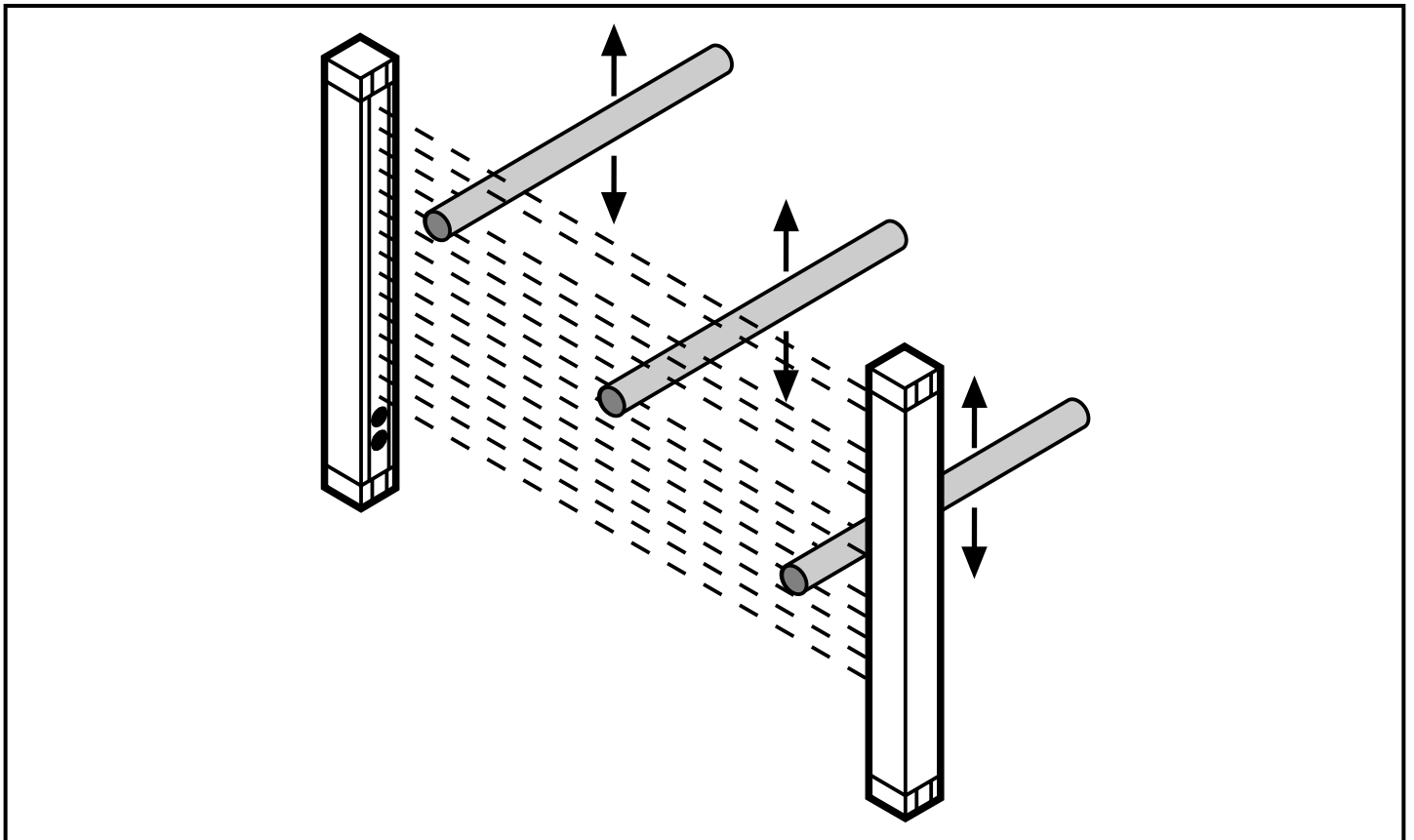

- ▶ Let the test object enter the protected area and move it slightly downwards. First of all in the centre and then close to the transmitter and the receiver.
- ▶ Make sure that the red LED on the receiver is continuously lit during the movement in the protected area.



Observe the notes on installation of the safety light curtains → 14 Maintenance, repair and disposal.



Notes on set-up → 17.1 Check list.

11 Scale drawing

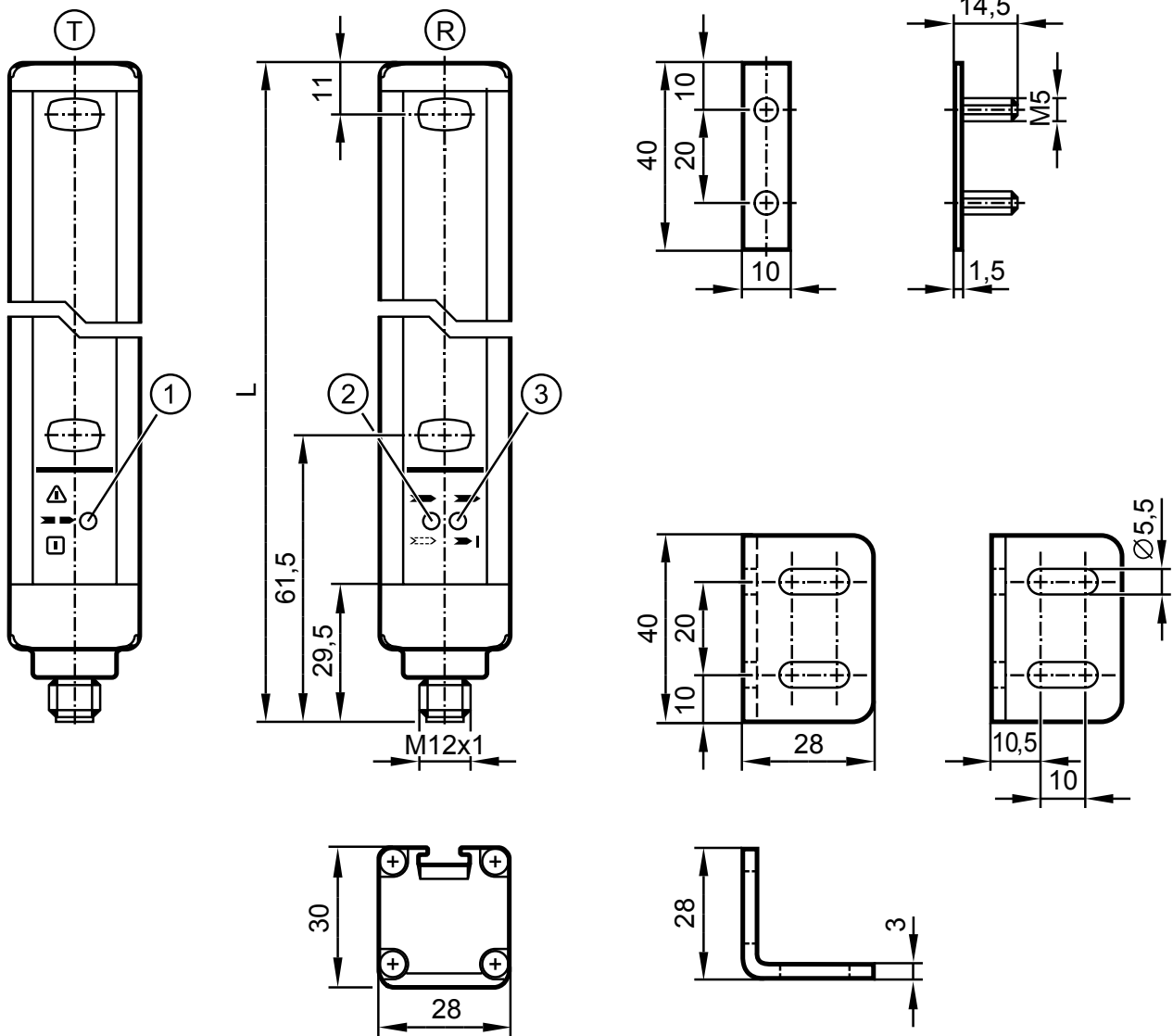

- T: transmitter
R: receiver
L: total length*
- 1: LED 3 colours (red/green/orange)
2: LED 2 colours (yellow/blue)
3: LED 2 colours (red/green)

* available lengths → 12 Technical data

12 Technical data

Conforms to the requirements of: Type 4 IEC 61496-1, SIL 3 IEC 61508, SILcl 3 IEC 62061, ISO 13849-1:2015 category 4 PL e	
Electrical design	DC / PNP
Operating voltage	24 DC (19.2...28.8)
Current consumption	
Transmitter [mA]	42
Receiver [mA]	83
Outputs (OSSDs)	2 x PNP
Max. current load per output [mA]	400 (24 V)
Max. capacitive load CL_max [μ F]	0.82
Power-on delay time [s]	< 2
Mission time T _M [h]	175200
EMC	IEC 61496-1
Vibration	IEC 61496-1
Shock	IEC 61496-1
Ambient temperature [°C]	-10...55
Max. perm relative air humidity [%]	95
Applications	Class C to EN 60654-1 weatherproof application
Protection	IP 65 / IP 67 / III
Housing material	aluminium, PC
Type of light	Infrared light 950 nm
Display	LED yellow, LED green, LED red, LED blue, LED orange
Connection	
Transmitter	M12
Receiver	M12
Max. cable length [m]	100 *)

*) for wire cross-section 0.34 mm²

12.1 Safety light curtains: 14 mm resolution

	OY001S	OY002S	OY003S	OY004S	OY005S	OY006S	OY007S	OY008S	OY009S	OY010S	OY011S
Total length L [mm]	213	363	513	663	813	963	1113	1263	1413	1563	1863
Protected area height [mm]	160	310	460	610	760	910	1060	1210	1360	1510	1810
Response time [ms]	4	5,5	7,5	9	11	13	14,5	16,5	18	20	20
Safety-related reliability PFH _D [1/h]	1,0 ⁻⁰⁸	1,3 ⁻⁰⁸	1,5 ⁻⁰⁸	1,8 ⁻⁰⁸	2,0 ⁻⁰⁸	2,3 ⁻⁰⁸	2,5 ⁻⁰⁸	2,7 ⁻⁰⁸	3,0 ⁻⁰⁸	3,2 ⁻⁰⁸	3,7 ⁻⁰⁸
Test pulse duration t _i [μs]	80	80	80	80	80	80	80	80	80	80	100
Test pulse interval T [ms]	3,9	5,7	7,5	9,3	11,1	12,9	14,7	16,5	18,3	20,1	23,7
Ratio t _i / T [%]	2,1	1,4	1,1	0,9	0,7	0,6	0,5	0,5	0,4	0,4	0,4

UK

13 Troubleshooting

The LEDs of the transmitter and the receiver indicate faulty operating states (→ 9 Operating and display elements). For a detailed fault description see the following tables.

13.1 Fault diagnosis transmitter

LED		Possible cause	Troubleshooting
red	2 consecutive pulses	Faulty connection pin 2/4	Check connections pins 2 and 4
red	3/4 consecutive pulses	Internal fault	Send device to ifm branch office for repair.

13.2 Fault diagnosis receiver

LED		Possible cause	Troubleshooting
red	2 consecutive pulses	Wrong configuration	Check connections.
red	3 consecutive pulses	Feedback external contactor missing	Check connection pin 4.
red	4 consecutive pulses	Interfering transmitter detected	Find interfering transmitter and take one of the following measures: <ul style="list-style-type: none"> - Reduce the range of the interfering transmitter from high to low. - Exchange position of transmitter and receiver. - Change location of the interfering transmitter so that the receiver is not influenced. - Screen the beams coming from the interfering transmitter using a mat protective device.
red	5 consecutive pulses	Fault OSSD outputs	Check connections. If the defect remains, send device to ifm branch for repair.
red	6/7 consecutive pulses	Internal fault	Send device to ifm branch office for repair.
yellow		Weak signal	<ul style="list-style-type: none"> - Check alignment of transmitter and receiver. - Clean front pane, check range. - Waiting for restart pulse.

14 Maintenance, repair and disposal

- Maintain the optoelectronic protective equipment in accordance with the applicable national regulations in effect within the requested intervals. The tests must be performed by qualified persons.
- It is recommended to regularly clean the front panes of the transmitter and the receiver.
- Clean the unit with a clean, damp cloth. In particularly dusty environments we recommend to spray the cleaned front pane with an antistatic product.
- Do not use any aggressive or abrasion-developing cleaning agents since they could attack the surfaces. To avoid electrostatic charging on the front do not use any woollen cloths.



Scratches on the front panes of the photoelectric safety sensors can deviate the light beams and impair the protective function.

- Only the manufacturer is allowed to repair the unit.
- After use dispose of the unit in an environmentally friendly way in accordance with the applicable national regulations.

15 Terms and abbreviations

Blanking		Optional function ensuring that objects are in the protected area which are larger than the detection capacity without the OSSDs switching off.
ESPE	Electro-Sensitive Protective Equipment	
CCF	Common Cause Failure	
DC _{avg}	Average Diagnostic Coverage	
Muting		Temporary bridging of a safety function by safety-related parts of the control system.
MTTF _d	Mean Time To Dangerous Failure	
OSSD	Output Signal Switch Device	Output signal switch element, static safety-related output.
PFH (PFH _D)	Probability of (dangerous) Failure per Hour	
PL	Performance Level	Capability of safety-related parts to perform a safety function at predictable conditions to fulfil the expected risk reduction.
SIL	Safety integrity level	SIL 1-4 to IEC 61508. The higher the SIL the lower the probability that a safety function will fail.
SIL _{cl}	Safety integrity level _{claim limit}	(to IEC 62061)
T _M	Mission Time	

Technical data and further information at www.ifm.com

16 Annex

16.1 Check list

This check list serves as help for setting up the safety light curtains. The requirements in this check list should to be met, however depending on the application and the directives / standards referred to.

1. Were the directives / standards valid for safety of machinery complied with?
2. Is access prevention / primary guarding of the point of danger only possible through the protected area of the safety light curtains?
3. Have steps been taken to prevent reaching under, over or around the light guards to prevent attempts to defeat them?
4. Has the stop or shutdown delay of the machine been measured and adapted according to the installation of the safety light curtains?
5. Have the safety light curtains been duly fixed and secured against loosening or movement?
6. Have the safety light curtains been checked according to the function and maintenance descriptions in these operating instructions?
7. Has external monitoring (EDM) of the control unit (e.g. contactor, valve etc.) been used?
8. Is the state defined as safe for switching on / off of the safety light curtains initiated?
9. Is /are there any soiling or scratches on the light-emitting surface?
10. Are the installation instructions of these operating instructions adhered to?



This check list does not replace checking or set-up by a person trained in safety matters.