

# DOUBLE END / CENTRE BRACKET

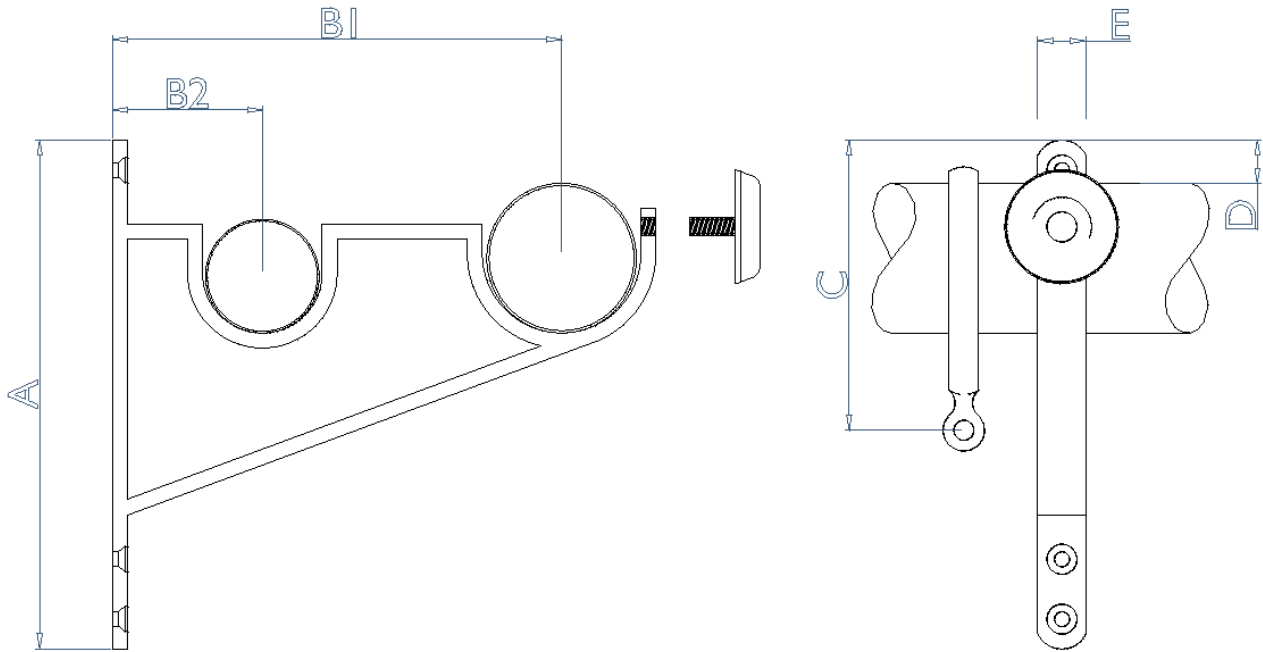

	DOUBLE END BRACKET					
POLE DIAMETER	A	B1	B2	C	D	E
19mm	110	MADE TO MEASURE	MADE TO MEASURE	60	12	19
25mm	120			60	15	19
32mm	135			80	20	19
38mm	150			85	20	19
50mm	170			90	10	19
63mm	180			100	10	19
75mm	190			110	10	19

	DOUBLE CENTRE BRACKET					
POLE DIAMETER	A	B1	B2	C	D	E
19mm	50	MADE TO MEASURE	MADE TO MEASURE	60	12	80
25mm	50			60	15	80
32mm	50			65	10	80
38mm	50			75	10	80
50mm	50			80	5	80
63mm	50			90	0	80
75mm	50			105	0	80

