

Financial Company Profile

May 2026



DE NORA
Dare. Develop. Deliver.

Agenda

- **De Nora in a Nutshell**
- Q1 2026 Business Achievements
- Q1 2026 Financial Results and 2026 Guidance
- Mid-Term View
- Sustainability Journey
- Investment case

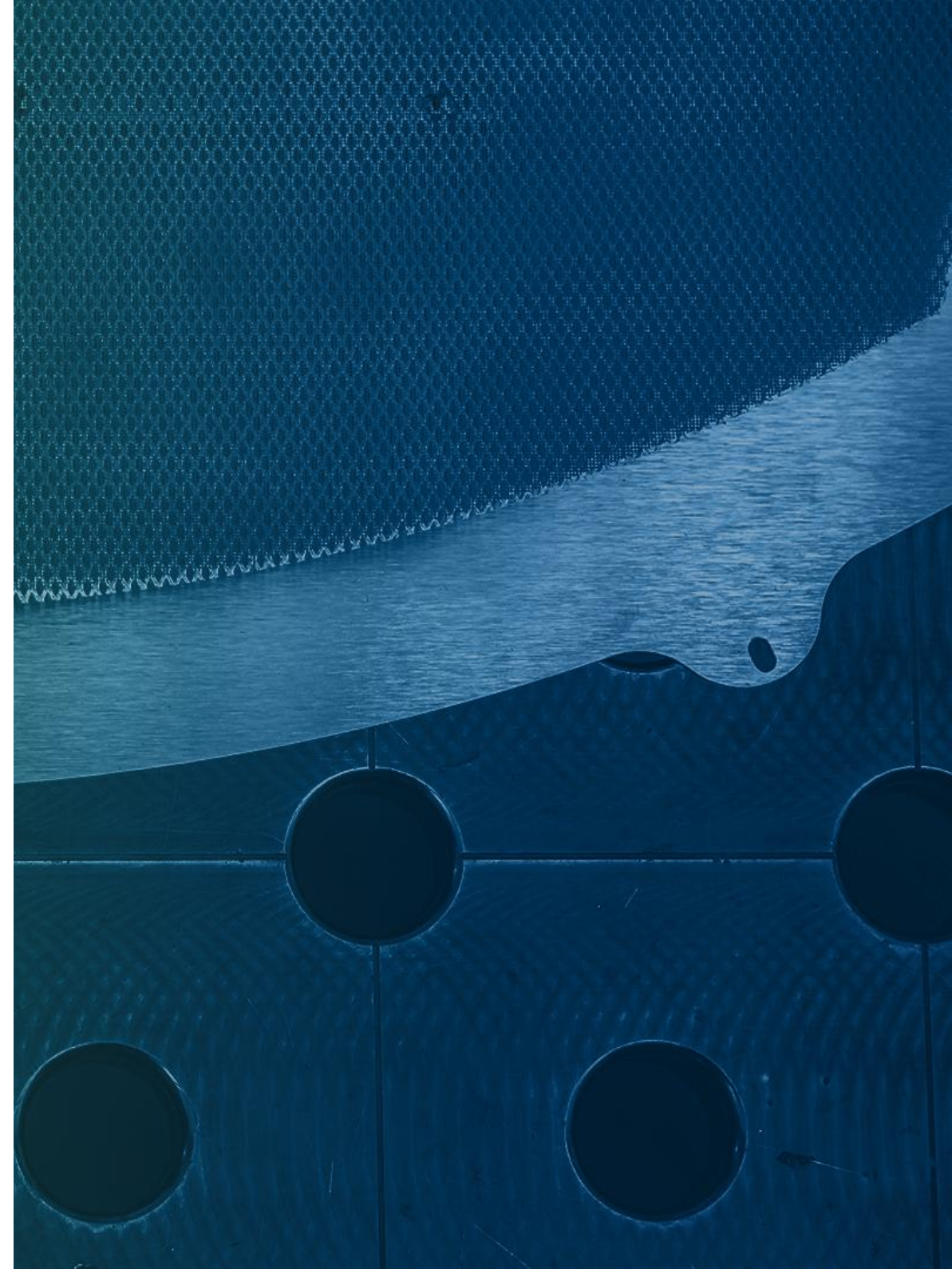

Who we are



Electrode Technologies

The world's largest supplier of **high-performing coatings** and **electrodes** for industrial applications.



Water Technologies

A trusted provider of disinfection and filtration solutions for **water** and **wastewater treatment**.



Energy Transition

Leading the way in emerging sustainable technologies, with a key role in the **Green Hydrogen** market.

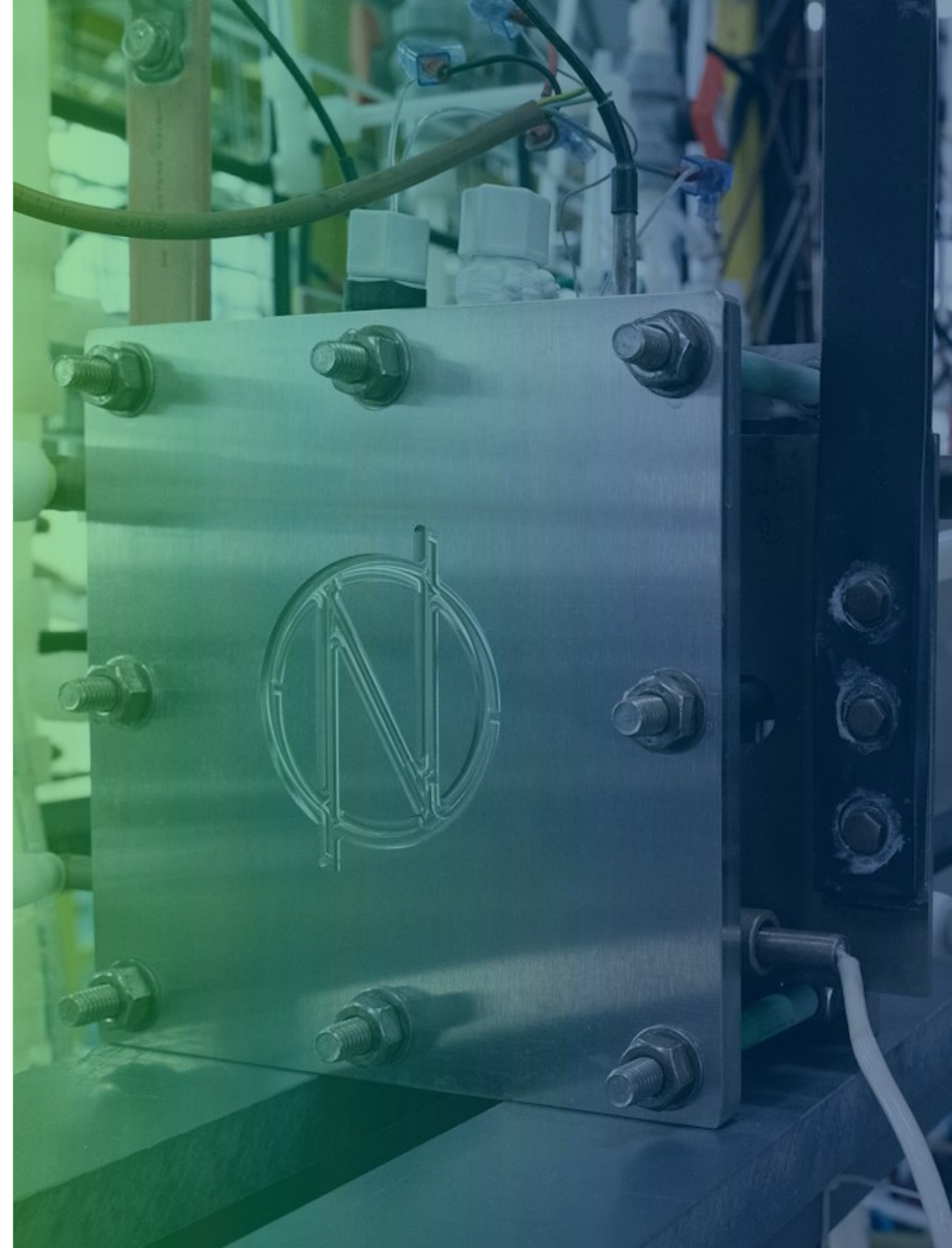

De Nora: three divisions, one soul

100 Years of Electrochemistry, to provide Sustainable Technologies



ELECTRODE TECHNOLOGIES

DSA(R) electrodes, Anodes, Cathodes, Gas Diffusion Electrodes, Cell Manufacturing for several industrial E-chem applications



ENERGY TRANSITION

Electrodes for Alkaline Water Electrolysis (AWE), Electrolysis Cells manufacturing and solution enabling circularity (Lithium refining and recycling)





WATER TECHNOLOGIES

E-chem & non-E-chem technologies for water Disinfection, Filtration and adsorption Technologies, Water and wastewater solutions, Electrodes for Pools

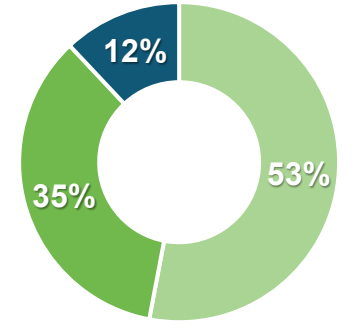

FY 2025 Revenues By Business Units



- Electrode Technologies
- Water Technologies
- Energy Transition

FY 2025 Revenues New Installations vs Services

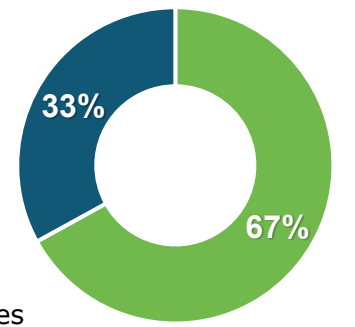

- New
- Services



MARKETS & LEADERSHIP



Chlor-alkali, Electronics, Nickel & Cobalt Electrowinning, Galvanic industries

> 50% market share



Green Hydrogen Production AWE Technology



Pools (> 80% Mkt share) & Industrial Electrochlorination;

Within the top 5 in municipal disinfection & filtration

Electrode Technologies

Addressing Multiple Industrial Applications with a Wide Range of Products

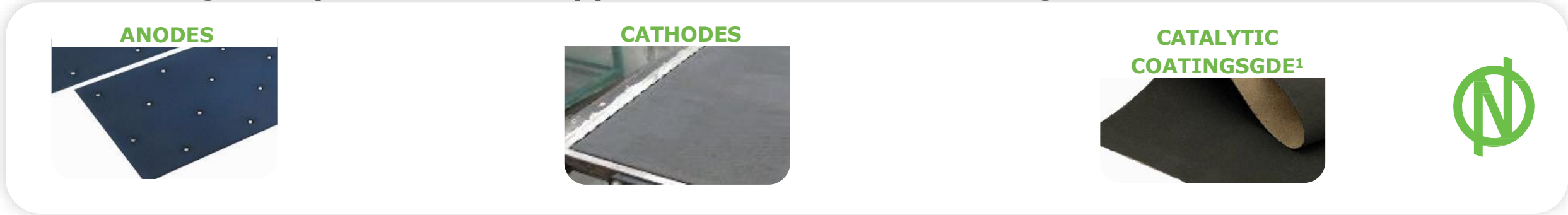

MAIN ADDRESSED INDUSTRIES

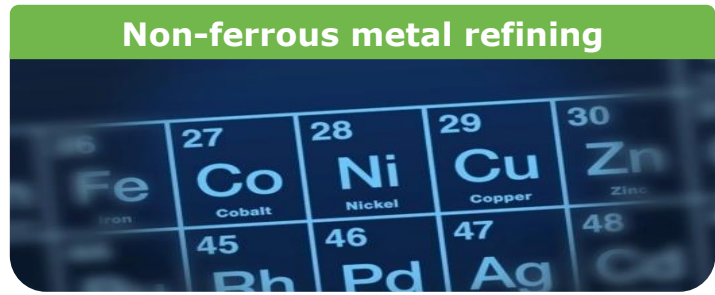
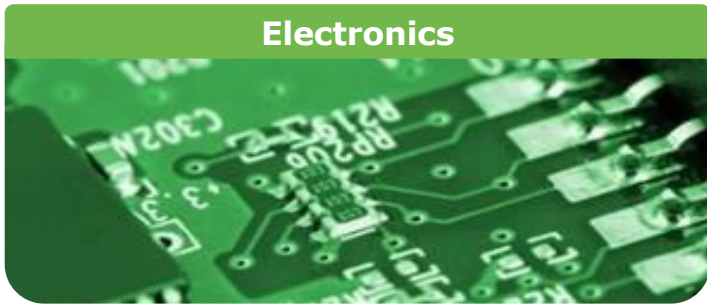

OTHER INDUSTRIES



Pulp & paper



Steel galvanizing



Automotive Chrome plating



Plumbing & furniture Surface finishing



Steel & concrete Corrosion protection



1 GDE: Gas Diffusion Electrodes

Electrode Technologies

Flagship projects

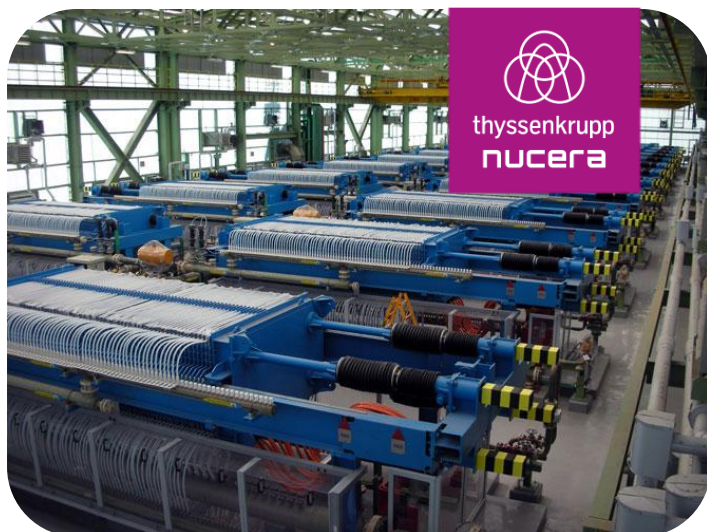

Sadara, Saudi Arabia Hydrochloric Acid Solutions

- First project 2013/2014
- Recoating Services 2022-2025
- Next recoating cycle 2028



Nan Ya (Formosa Plastics Corp.), Taiwan Copper foil production for PCB & LiB

- Supply and maintenance services for the electrodes equipping for Cu foil production
- Delivery by 2026

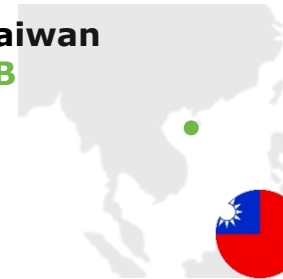

OxyChem, US Chlor Alkali Plants

- Environmental compliance and performance improvement
- **PMX separators for Diaphragm** Ongoing
- **Converting to membrane tech.** Delivery by 2026



Water Technologies

Leading Solutions to Provide a Sustainable Water Management

APPLICATIONS



Pools

Self-cleaning metal-coated titanium electrodes for salt chlorinators



WATER TECHNOLOGIES SYSTEMS (DISINFECTION AND FILTRATION)

Municipal

Industrial

Gas feed chlorination & Ozone systems, - Chlorine dioxide and Ultraviolet treatment - Gravity and pressure media filtration - Ion exchange - Seawater, onsite and advanced electro-chlorination plants and systems - PFAS contaminants removal

PORTFOLIO – main brands



Electrodes for pool chlorinators

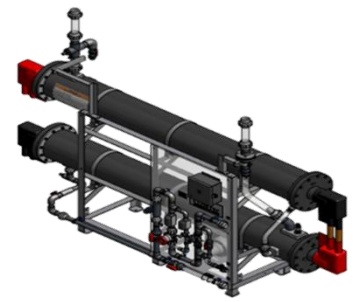

ClorTec® On-Site Hypochlorite Generators



Capital Controls® Ozone Generators



CECHLO® On-Site Generators



Capital Controls® UV Systems



SORB™ Contaminant Removal (PFAS)



Water Technologies

Flagship projects



Al Jubail, Saudi Arabia – Phase II *Desalination Plant upgrade*

- The world’s largest Seawater Reverse Osmosis desalination plant
- Up to **1m m³/day** seawater

DE NORA TECHS
SEACLOR®
DE NORA TETRA®
CAPITAL CONTROLS®
Chlorine Dioxide



Seaclor®



Tubli, Bahrain – Phase IV *Sewage Treatment Plant expansion*

- One of the largest wastewater treatment plants in the Middle East
- **Flow capacity of 400k m³/day**

DE NORA TECHS
CAPITAL CONTROLS®
Ozone Generators



Capital Controls® Ozone Generators



Hong Kong *Water Supplies Department*

- 10 water treatment works provide safe and reliable water to the city
- **Drinking Water to ~8m citizens**

DE NORA TECHS
CECHLO®
CAPITAL CONTROLS®
Gas feed systems



Cechlo®



PFAS: strong start – 10 contracts signed

10 Industrial Scale

projects, to be delivered by 2026-'27

~ €7m

Backlog @31 Mar. 2026

PFAS

Removal from Drinking Water

SORB FX

De Nora Solution



SORB FX
Contaminant removal systems

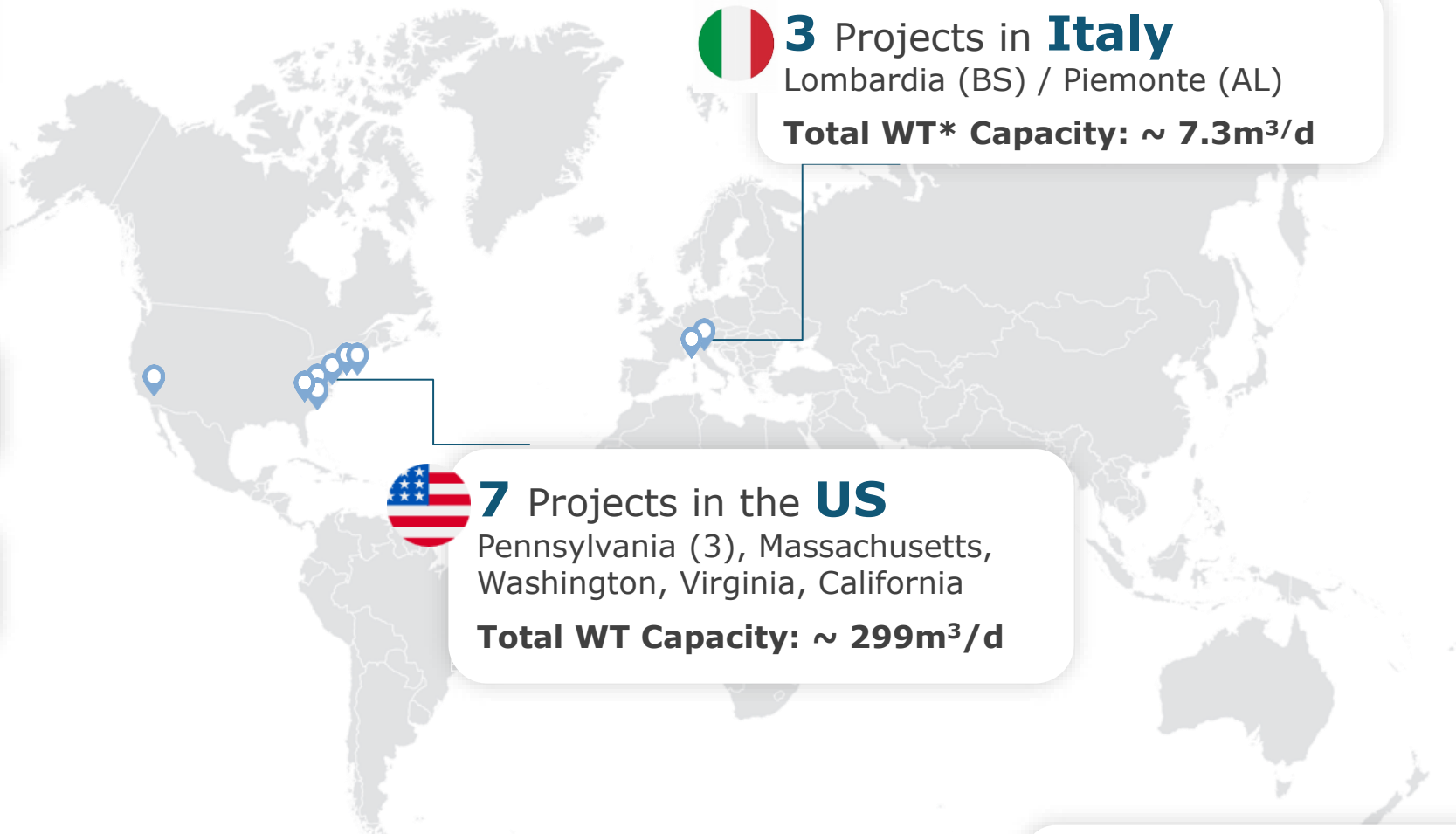

3 Projects in **Italy**

Lombardia (BS) / Piemonte (AL)

Total WT* Capacity: ~ 7.3m³/d



7 Projects in the **US**

Pennsylvania (3), Massachusetts, Washington, Virginia, California

Total WT Capacity: ~ 299m³/d

**8 field pilots
underway**

in AMS (5) and EMEA (3)

*WT- Water Treatment

Energy Transition

Technological Leader in the Green Hydrogen Industry and circularity

Application Decarbonization and Circular Economy

Green Hydrogen Production



Hard-to-Abate



Circular Economy:
Lithium Refining and Extraction



PORTFOLIO

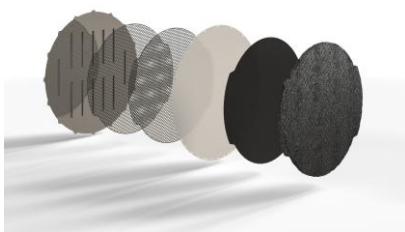

Electrodes for Alkaline Water Electrolysis (AWE)



Electrolysis Cells



Stack for AWE

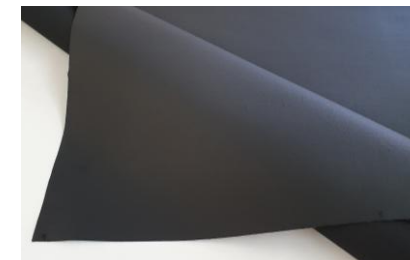

Gas Diffusion Electrodes for fuel cells



Small Scale Electrolyzer DRAGONFLY®



Energy Transition

Excellent Hydrogen **flagship execution** — positioning De Nora as a technology leader...

WORLDWIDE FLAGSHIP PROJECTS COMPLETED IN 2025

NEOM 2.2 GW

Saudi Arabia



33,000 E-Chem cells delivered

Largest global Green H₂ Project
5m tons/Y CO₂ avoided



STEGRA 740 MW

Sweden



11,000 E-Chem cells delivered

First large-scale green steel EU

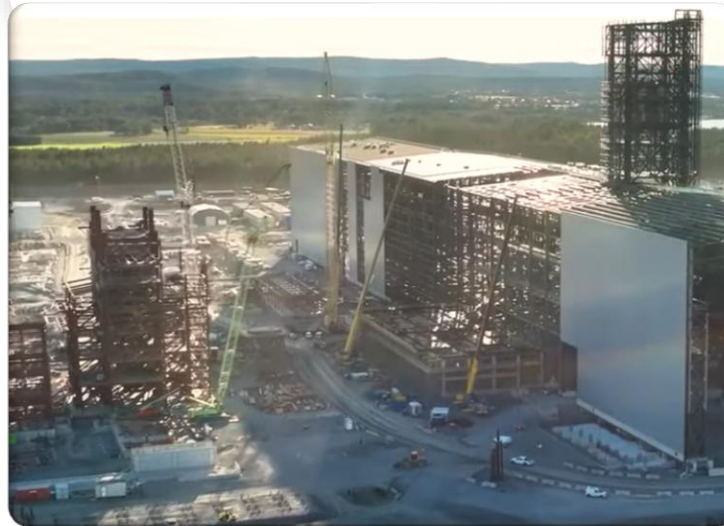

GREEN H₂ TRACK RECORD

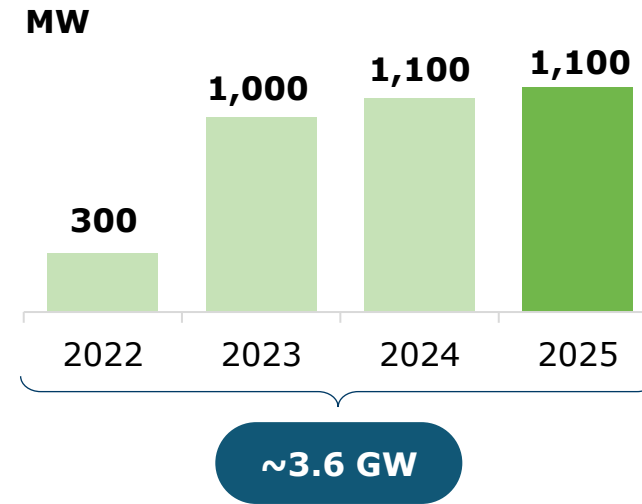

Innovation, growth, leadership & partnerships

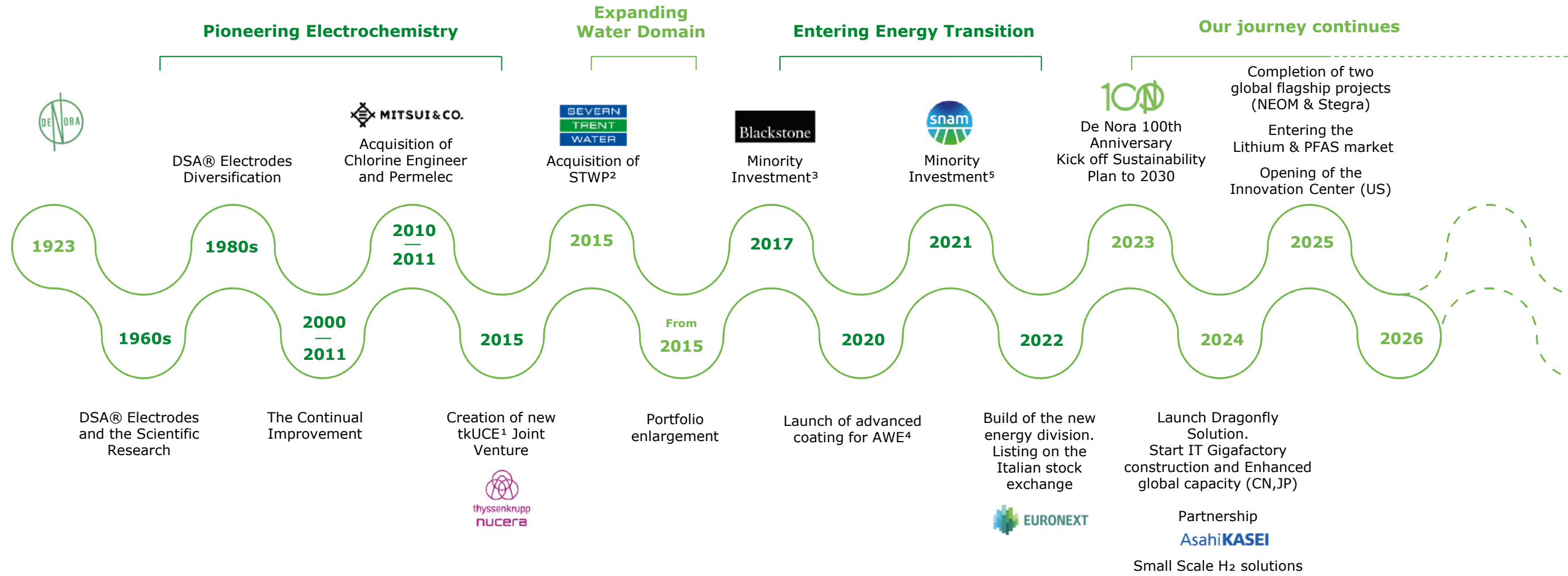

Equipped to drive growth and seize opportunities



23
Operating companies



13
Manufacturing sites

Worldwide manufacturing capacity

2.5
GW eq.¹ Energy Transition
1.0 mil.
Sqm per year
40,000 cells per year



5 + 1
R&D Labs worldwide
Innovation Center in Mentor



275
Patent families
2,800+ geo extensions



€875.0 m
2025 FY Revenues



~2080
People



1. Elements Equivalents
* EMEIA = Europe, Middle East, India & Africa

Manufacturing facilities **People**
(approx. data)

Data as of 31 December 2025



Agenda

- De Nora in a Nutshell
- **Q1 2026 Business Achievements**
- Q1 2026 Financial Results and 2026 Guidance
- Mid-Term View
- Sustainability Journey
- Investment case

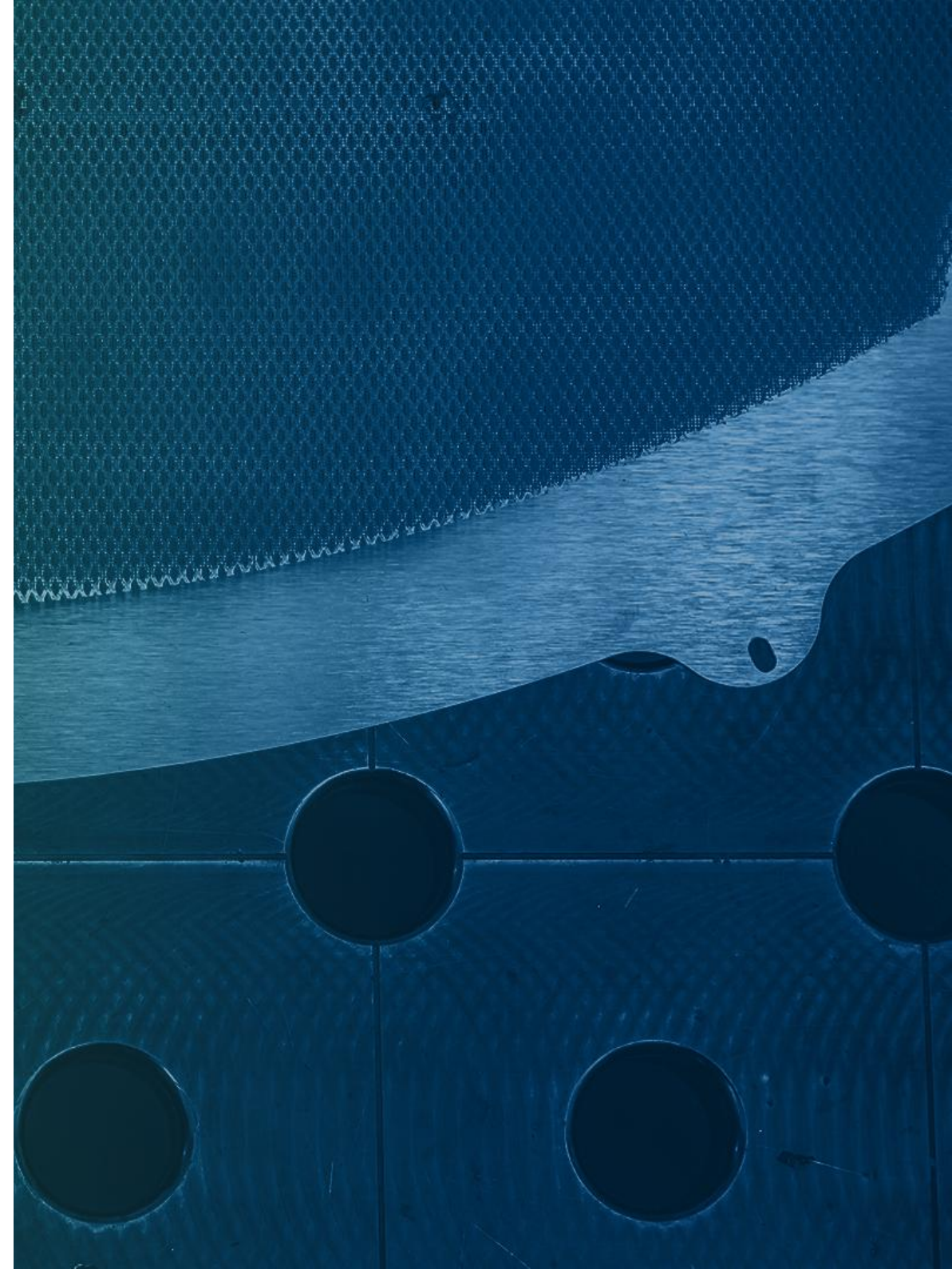

Q1 2026 results highlights

Solid profitability and backlog growth in core businesses



Well-anchored business model to successfully navigate in a complex geopolitical scenario



Q1 2026 Solid profitability across core businesses, despite the expected soft revenue performance



New orders up 33% YoY, driving **core business backlog** to its **highest level** in the last **two years**



Energy Transition: Building up presence in lithium, while securing **first orders** for the **Moeve** green H₂ project in Spain



2026 Guidance, Revenues and EBITDA margin trending towards the **upper end of the range**

Q1 2026 KEY RESULTS

€ 178.5 m Revenues
-3.6% YoY at constant fx

€ 36.0 m Adj EBITDA
20.2% margin

€ 254 m New Orders
+33% vs Q1 2025

€ 506.6 m Backlog
+12.5% vs 31 Dec. 2025

Q1 2026 results

Core business delivering robust profitability, while backlog is improving supported by 33% order growth

REVENUES

€178.5 m

-3.6% @ constant fx

ADJ. EBITDA

€36.0 m

20.2% Adj. Ebitda margin

NET RESULT

€18.0 m

+12.4% YoY

NET CASH POSITION

€2.5 m

€27.8 m @31 March 2025

ELECTRODE TECH

€85.6 m Revenues

20.4% Adj. Ebitda margin

WATER TECH

€84.9 m Revenues

25.8% Adj. Ebitda margin

ENERGY TRANSITION

€8.0 m Revenues

(3.4) m Adj. Ebitda

BACKLOG

€506.6 m

+12.5% Vs 31 Dec. 2025



Electrode Technologies

Highest backlog in the last six quarters

ORDER INTAKE: +63% YoY

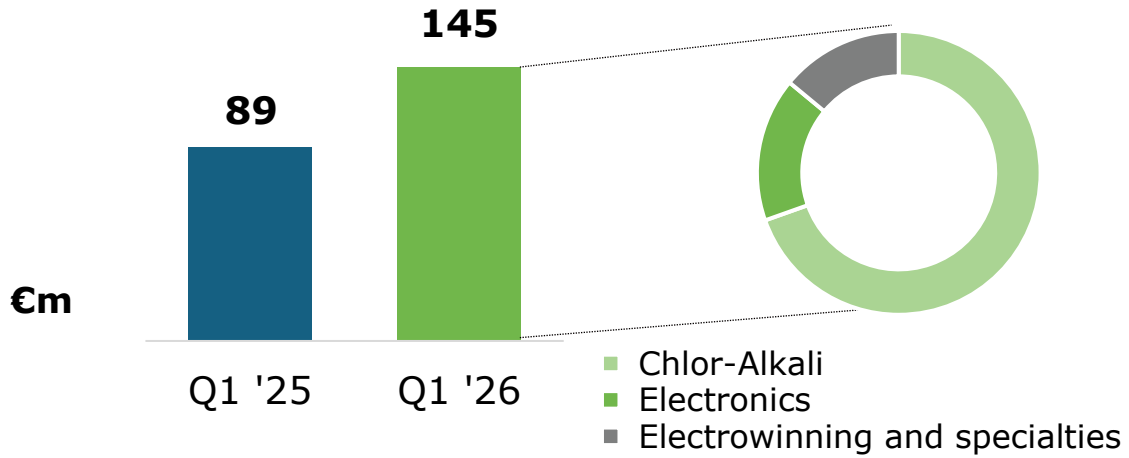

BACKLOG: +7.2% YoY

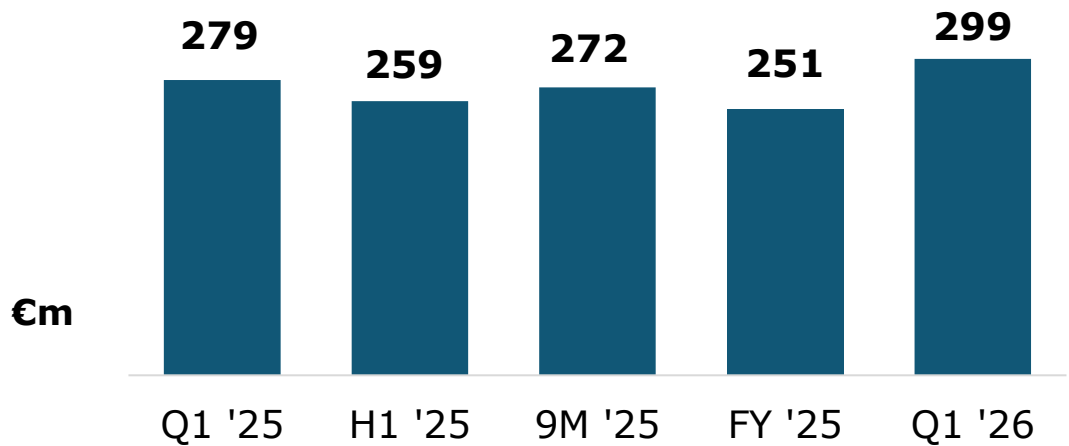

ORDERS BY TYPE

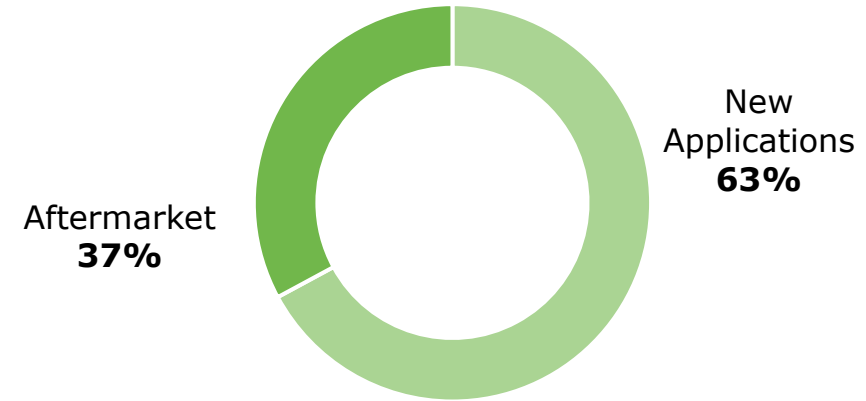

ORDERS BY GEOGRAPHIES

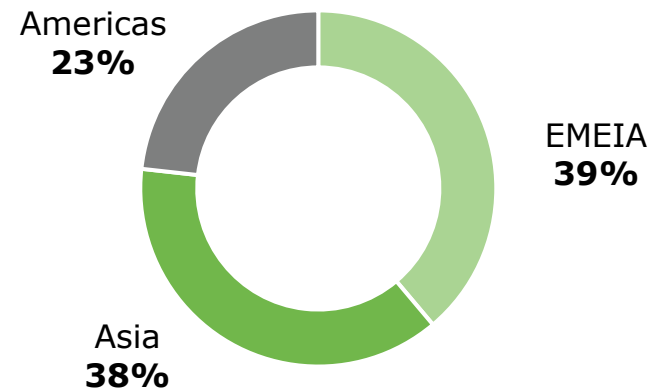

Water Technologies

Triple-digit growth in Pools orders and backlog

ORDERS: UP 10% YoY

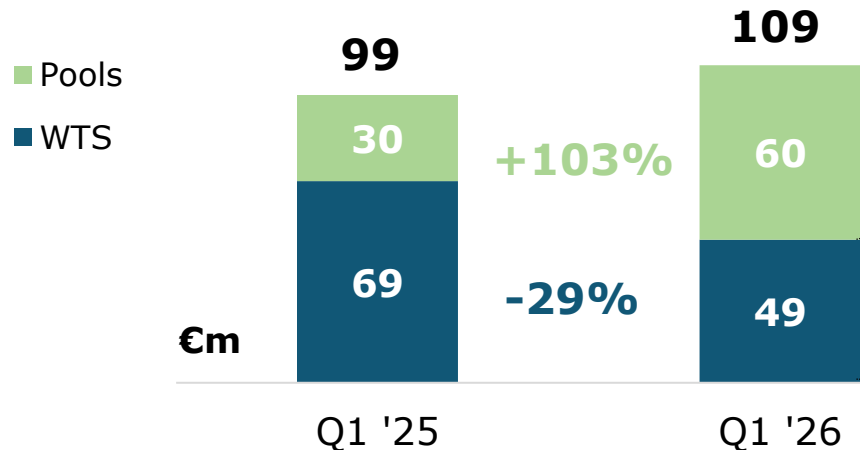

WTS ORDERS BY TYPES

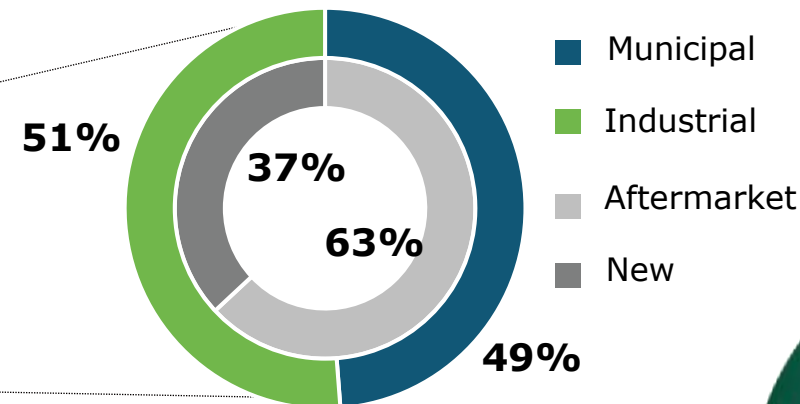

BACKLOG: UP 15% vs Q1 '25

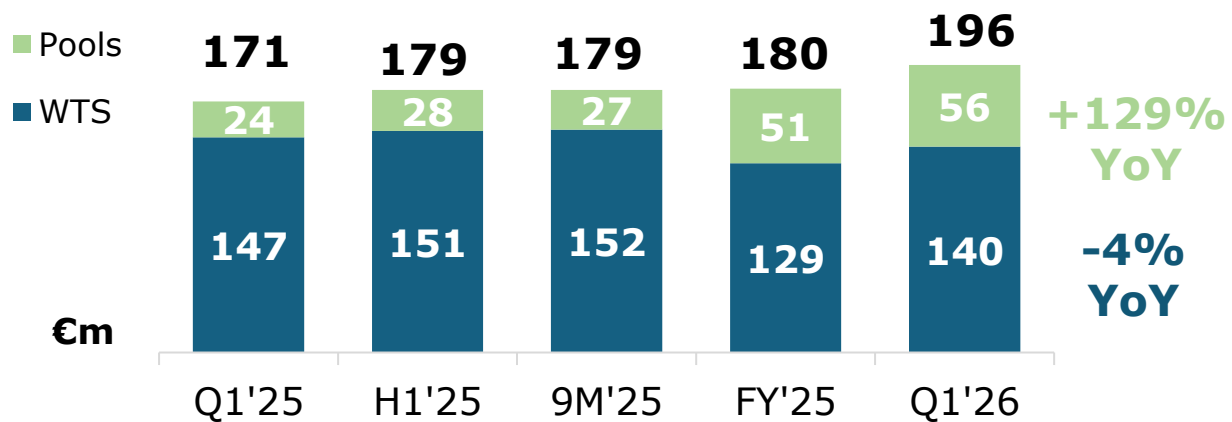

ORDERS BY GEOGRAPHIES

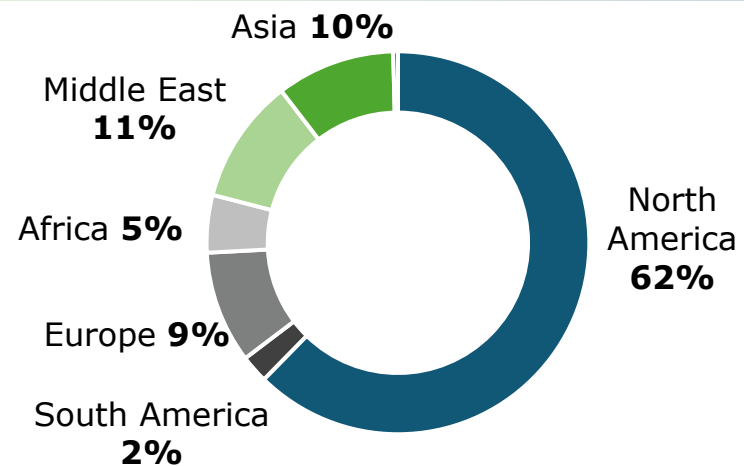

Energy Transition

Green shoots of recovery

LITHIUM REFINING Q1 2026 AGREEMENTS / CONTRACTS



2026 Agreement with **Tuleva** for **largest US electrochemical Lithium** Plant

Contract value **€10m+**
(to be finalized)



2026 Lithium Recovery **JP customer** for a government-backed demonstrating Proj.
(~**€3m**)



2026 Partnership with **Reed Advanced Materials** to develop joint technology

LARGE SCALE GREEN HYDROGEN



~**2 GW**



Of **FEED* – phase** projects involving our **juv nucera**, including the **MOEVE** project in Spain (FID reached)



MOEVE (Spain), **300 MW**
Southern EU's largest green H₂ Prj.
Partial orders secured in May'26



ENERGY TRANSITION BACKLOG

Backlog at 31 March 2026

€12 m

Not yet including

~**€30 - €40 m**

Moeve prj.
to be booked by Q2 2026

* FEED: Front End Engineering Design



Energy Transition regulation update

As the global energy landscape becomes more complex and green H₂ emerges as a source of energy independence, supportive regulations are developing worldwide

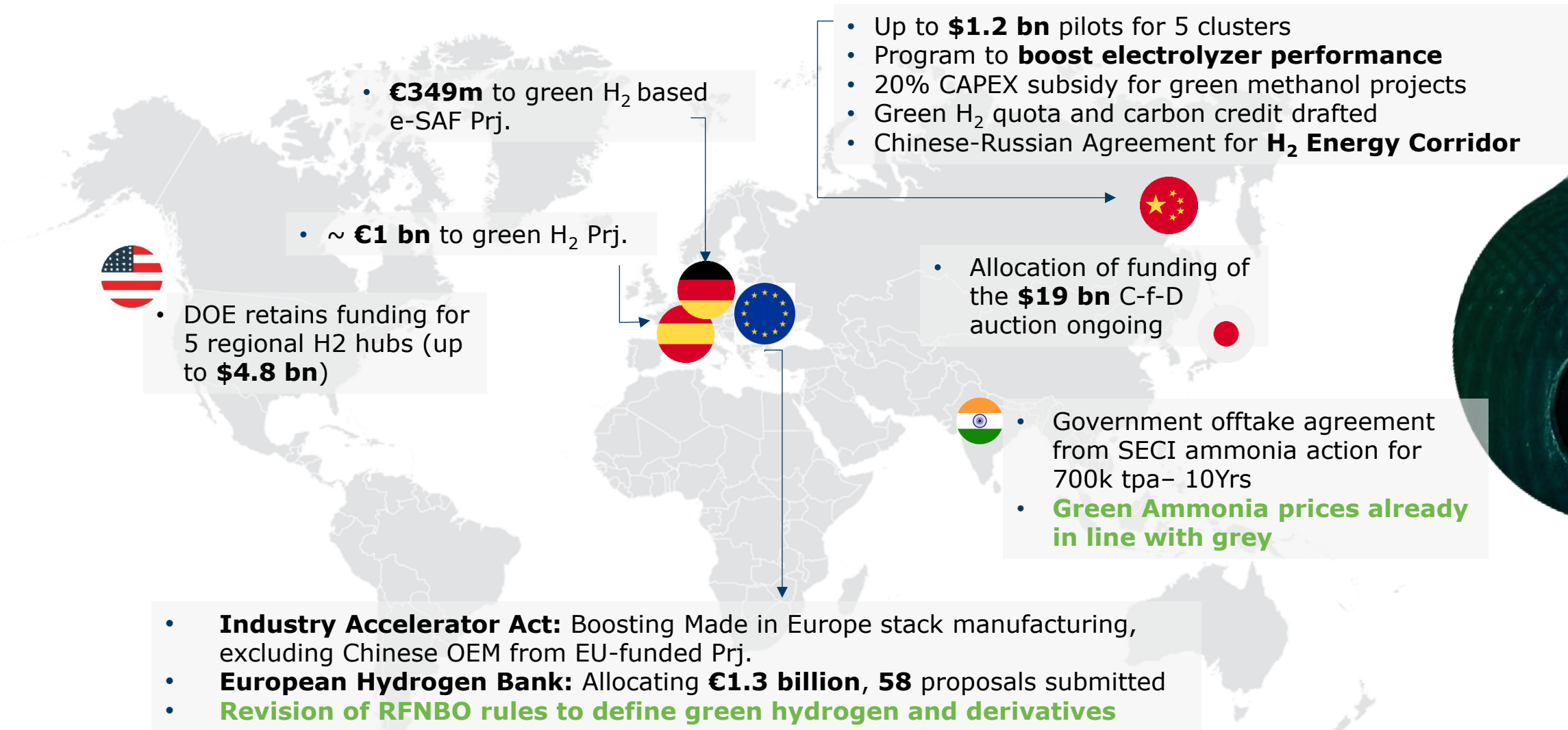

Agenda

- De Nora in a Nutshell
- Q1 2026 Business Achievements
- **Q1 2026 Financial Results and 2026 Guidance**
- Mid-Term View
- Sustainability Journey
- Investment case

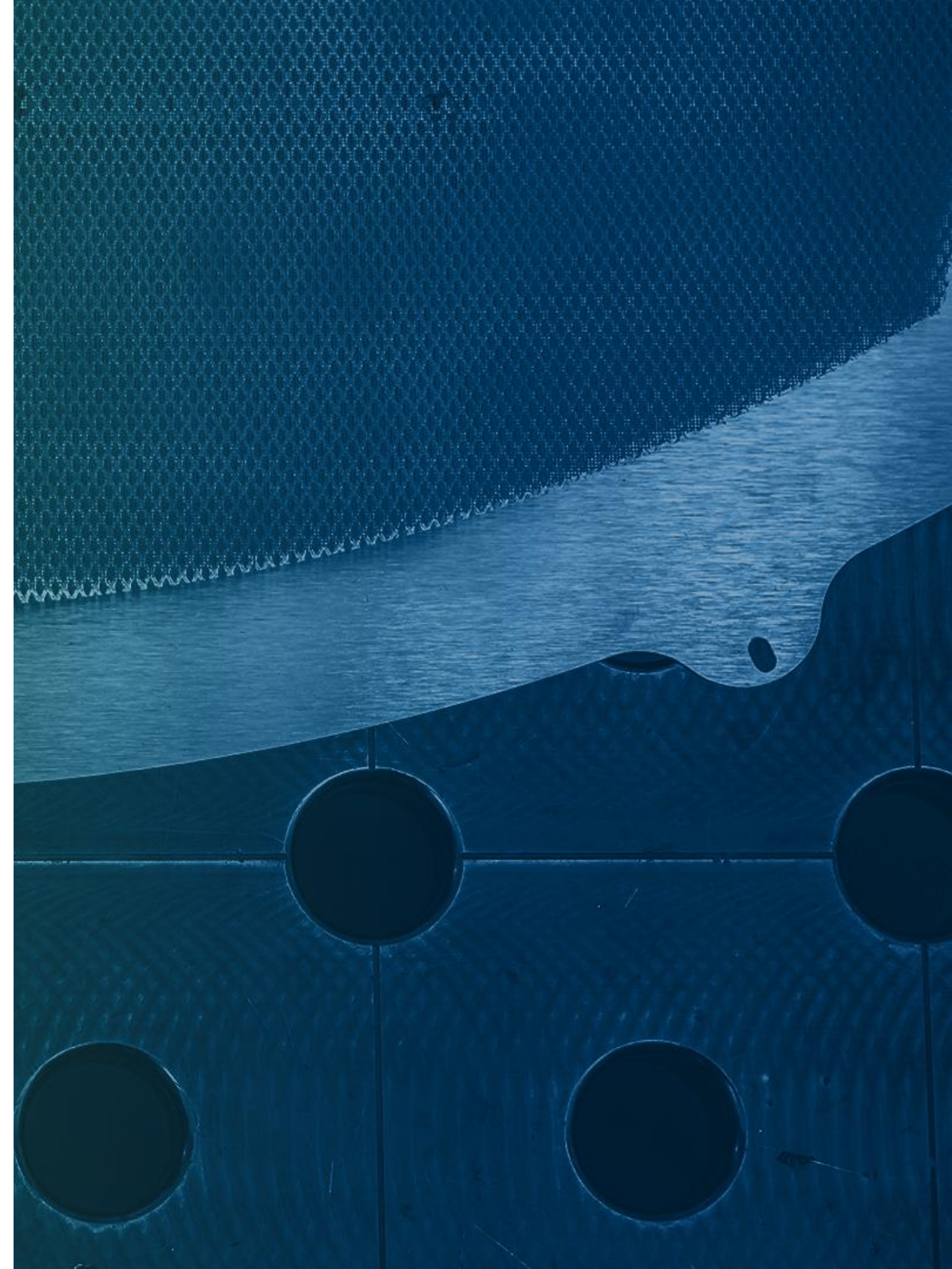

Q1 2026 revenues

Top line trended as expected

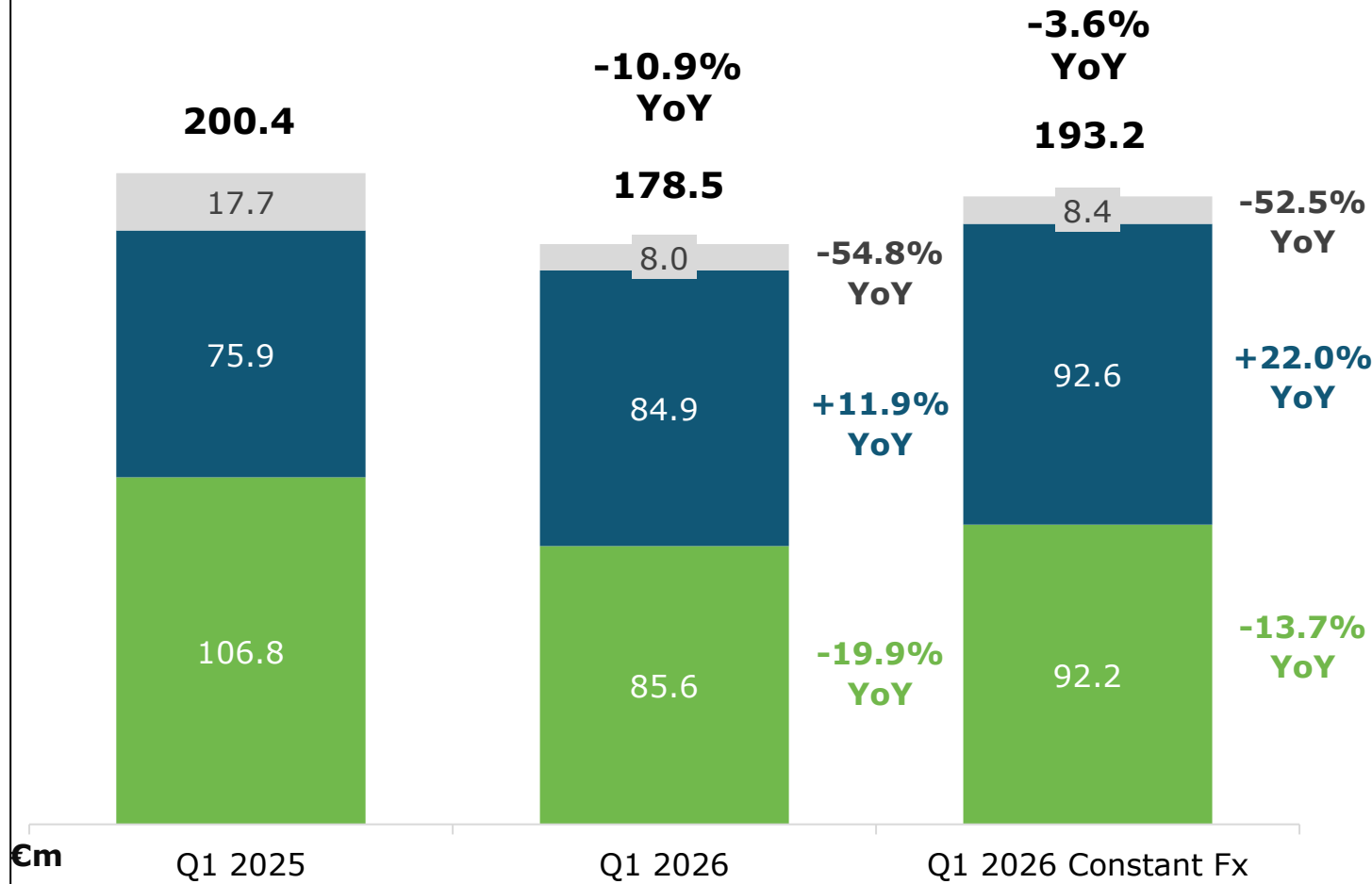

Revenues By Geography

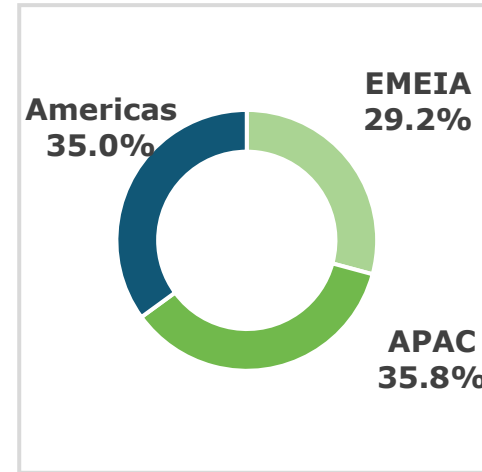

Revenues By Type

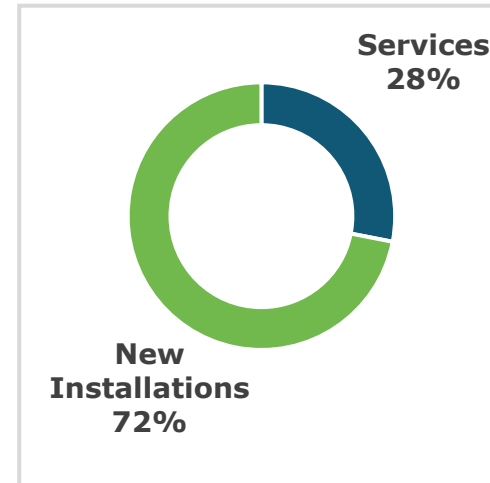

KEY HIGHLIGHTS

ELECTRODE TECHNOLOGIES

- In line with expectations
- The figure reflects project scheduling and €7m negative FX impact
- Aftermarket Revenues at **40%**

WATER TECHNOLOGIES

- **Pools +53.7%** YoY driven by price increases due to **raw material inflation**
- WTS¹ softer performance driven by project scheduling and €3m negative FX effects
- **WTS Aftermarket** revenues **47%**

ENERGY TRANSITION

- Revenues in line with expectations, driven by backlog execution



1.WTS: Water Technologies Systems



Q1 2026 backlog

Core Business: highest backlog in the last 2 years

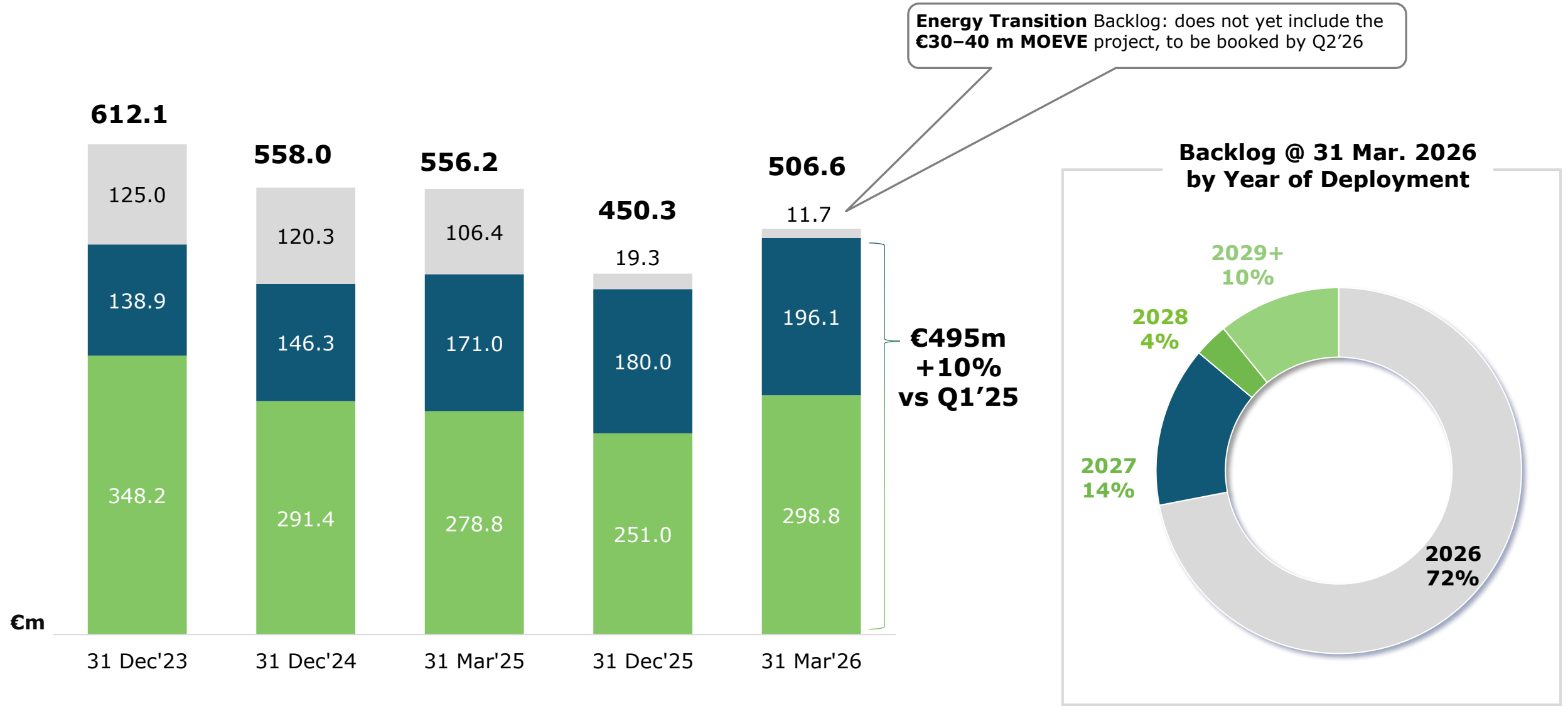

Energy Transition



Water Technologies



Electrode Technologies



Q1 2026 operating costs

Stable corporate structure and R&D costs

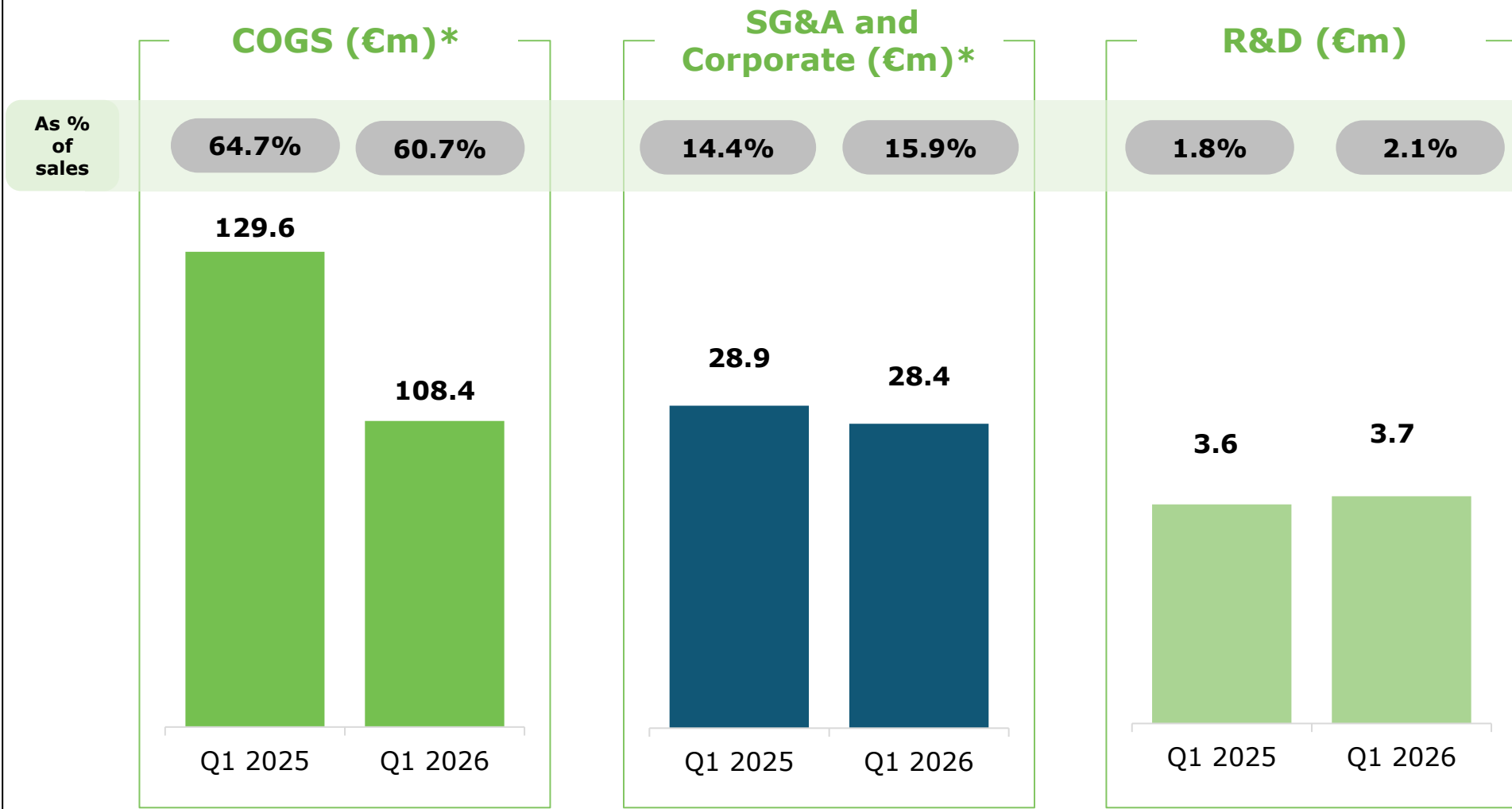

KEY HIGHLIGHTS

- **COGS**
- Incidence reduction due to revenue mix
- **SG&A and Corporate**
Stable despite inflationary effects
- **R&D**: recurring costs broadly stable vs Q1 2025
- **€1.2m** expenses related to **IPCEI project** not included
- **5 researchers** hired

*Net of non-recurring costs (income): 1) COGS: € 3.3m in Q1 26, € 1.6m in Q1 25; 2) SG&A: € 1.0m in Q1 26, € 0.8m in Q1 25



Adjusted EBITDA Q1 2026

Adj EBITDA margin increase underpinned by Water Technologies

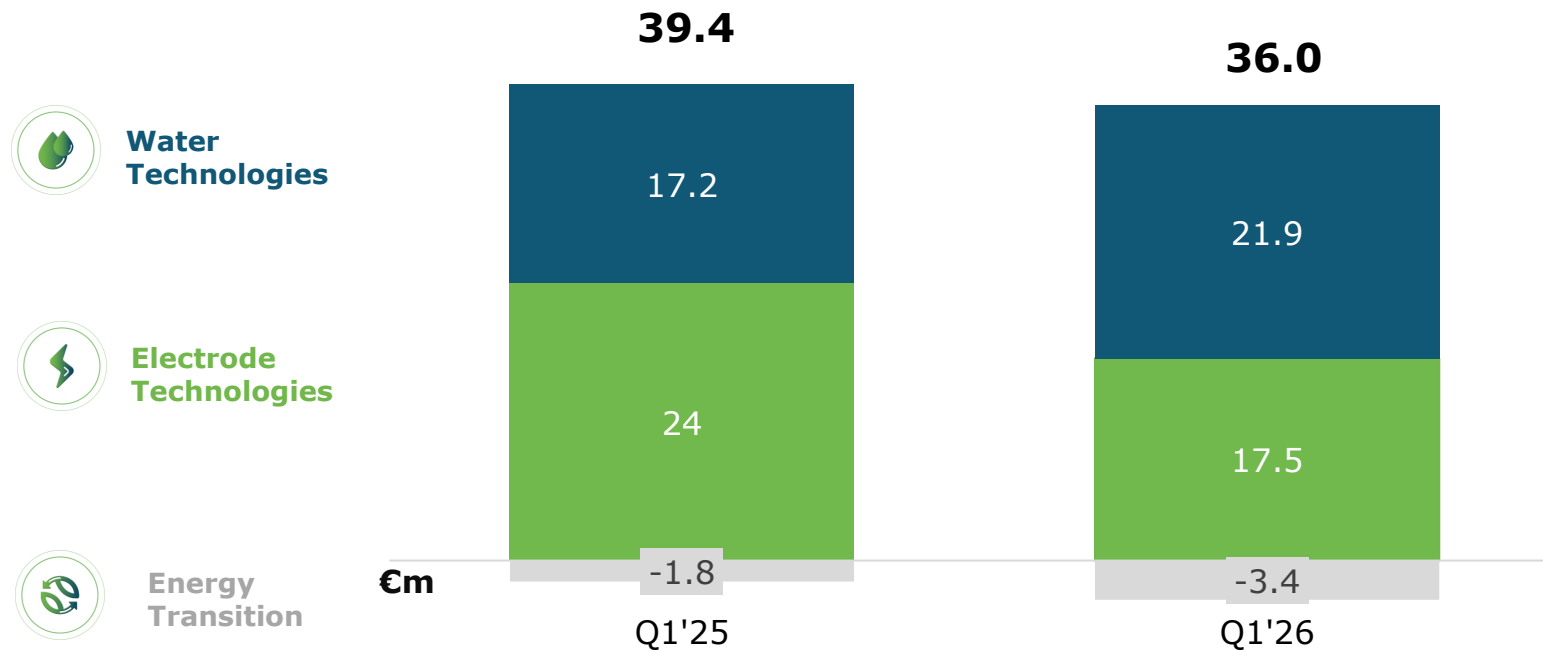

KEY HIGHLIGHTS

ELECTRODE TECHNOLOGIES

- Performance is mainly driven by the product mix and lower volumes

WATER TECHNOLOGIES

- **+27%** Adj. EBITDA driven by revenue mix, with higher-margin **Pools** line accounting for **60%** of BU revenues (43% in Q1 2025)

ENERGY TRANSITION

- Profitability trend driven by lower volume
- Recurring R&D costs at ~28% of reported revenues

	Q1'25	Q1'26
Adj. EBITDA Margin	19.7%	20.2%
<i>Electrode Technologies</i>	22.5%	20.4%
<i>Water Technologies</i>	22.7%	25.8%
<i>Energy Transition</i>	(10.2%)	(42.5%)



Net Financial Position

Reflecting typical Q1 NWC seasonality and the impact of higher critical raw material costs

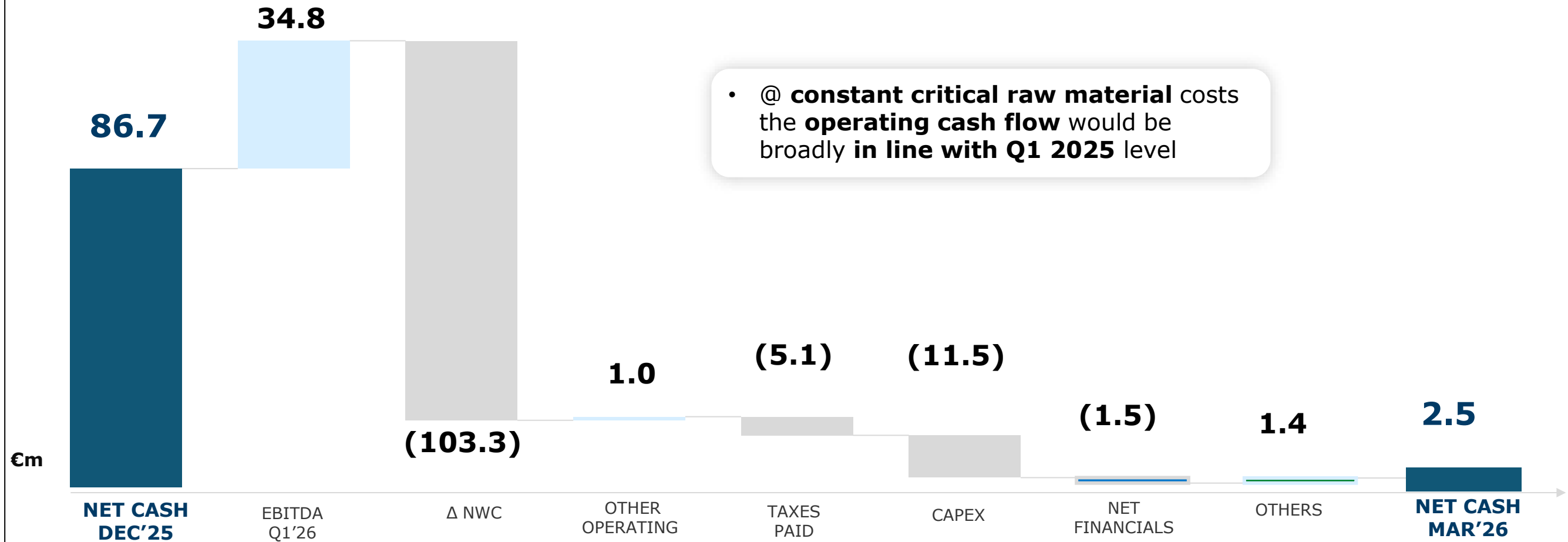

• @ **constant critical raw material** costs the **operating cash flow** would be broadly **in line with Q1 2025** level



2026 Guidance

Revenues

€ 750 m – € 850 m



Heading toward the upper end of the range



Electrode Technologies
High to mid single-digit decline



Upper end of the range



Water Technologies
Mid single-digit to low double-digit growth



Upper end of the range



Energy Transition
€ 15 m - € 60 m



Range confirmed

Adj EBITDA margin

15% – 18%



Heading toward the upper end of the range

CAPEX ~ €80 m

50% Maintenance & Operations, 50% Gigafactory/Other Real Estate



Tracking in line



Agenda

- De Nora in a Nutshell
- Q1 2026 Business Achievements
- Q1 2026 Financial Results and 2026 Guidance
- **Mid-Term View**
- Sustainability Journey
- Investment case

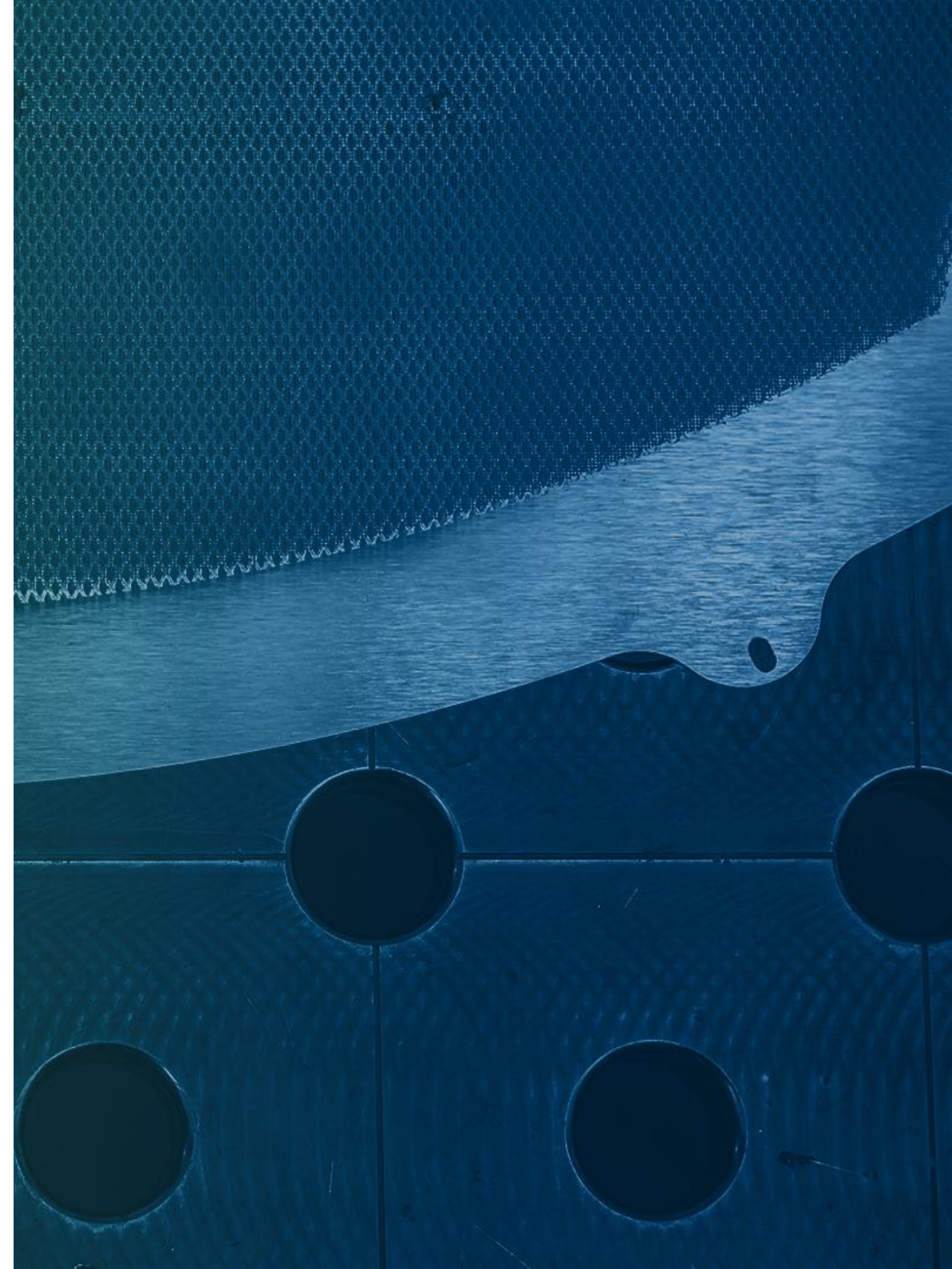

Electrochemistry and Water Solutions at the heart of key megatrends

GLOBAL WATER SCARCITY

- Growing pressure on water Resources
- Sustainability initiatives acceleration
- Rising industrial demand pushing circular solutions

CIRCULAR ECONOMY

- Valorizing precious chemical compounds
- Refining and recovering critical high value raw materials
- Material efficiency & life-extension

ENERGY TRANSITION

- Energy security & independence
- Decarbonization of hard to abate industries and electrification...
- ... Hydrogen as critical enabler



Mid-term Strategy across our Businesses

Where electrochemical and water treatment solutions power growth



ELECTRODE TECHNOLOGIES

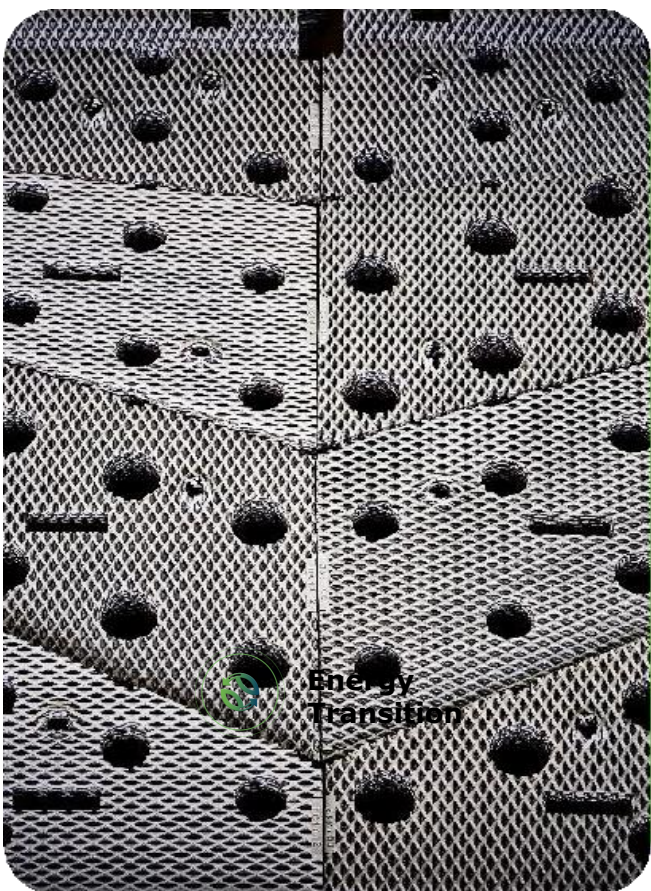

WATER TECHNOLOGIES



HYDROGEN



CIRCULARITY



Electrode Technologies

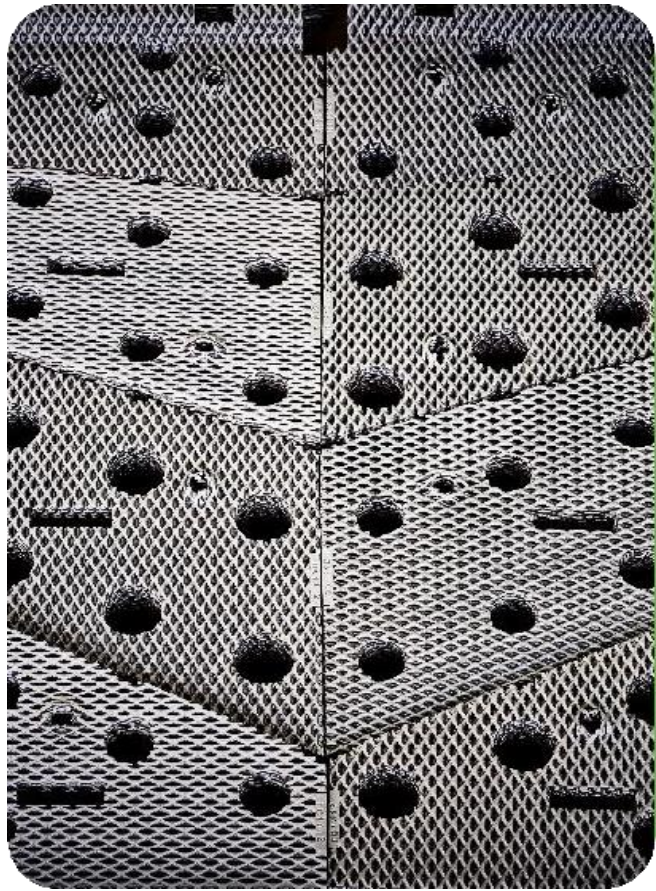

Enhance market coverage by leveraging our leading position, best-in-class technologies, and customer-centric approach

ELECTRODE TECHNOLOGIES



De Nora STRATEGY

Mid-term strategic levers

-  Continuous improvement of the **technology suite**
-  **Expanding Service** offering to better support customers
-  Leveraging and strengthening **strategic partnerships**

Additional strategic levers

-  **Vertical integration** in selected spaces

De Nora's Current MARKETS

CHLOR-ALKALI

Mkt CAGR ₂₅₋₃₀	De Nora Mkt Share	Key Geo
LOW SINGLE-DIGIT	>50%	

ELECTRONICS

Mkt CAGR ₂₅₋₃₀	De Nora Mkt Share	Key Geo
MID SINGLE-DIGIT	~40%	

ELECTROWINNING

Mkt CAGR ₂₅₋₃₀	De Nora Mkt Share	Key Geo
LOW SINGLE-DIGIT	~50%	



Water Technologies



Boosting market penetration by improving our technology portfolio and moving toward turn-key solutions

WATER TECHNOLOGIES



De Nora STRATEGY

Mid-term strategic levers

-  Enhancing **WT portfolio** by leveraging E-Chem
-  Developing **PFAS²** (capturing & destruction) market
-  Strengthening **existing geo.**

Additional strategic levers

-  Entering **new geo.** & fast-growing **markets**
-  Vertical Integration to provide **Turn-Key Solution**

De Nora's current MARKETS

POOLS

Mkt CAGR ₂₅₋₃₀	De Nora Mkt Share	Key Geo
MID to HIGH SINGLE-DIGIT	>80%	

WTS

Mkt CAGR ₂₅₋₃₀	De Nora Mkt Share	Key Geo
MID SINGLE-DIGIT	Top 3 - 5 players	

PFAS³

Investments in capturing & destruction

~\$3.3bn	Mkt CAGR₂₅₋₃₀ ~8.5%
2030	

DE NORA Market Entry 2025 (8 contracts)

1. E-Chem = Electrochemical 2. PFAS = Per- and Polyfluoroalkyl Substances. 3. Source GWI



Green Hydrogen



Leveraging AWE¹ technological leadership to expand our solution offering

HYDROGEN



De Nora STRATEGY

Mid-term strategic levers

-  Enhancing **alliances** to accelerate growth
-  Partnerships to co-develop **flexible solutions**
-  Continuous technology **innovation**

Additional strategic levers

-  Expanding **Dragonfly**[®] proprietary solution offering
-  New Techs: **AEM**²

Green H₂ MARKET (cum. GW installed)

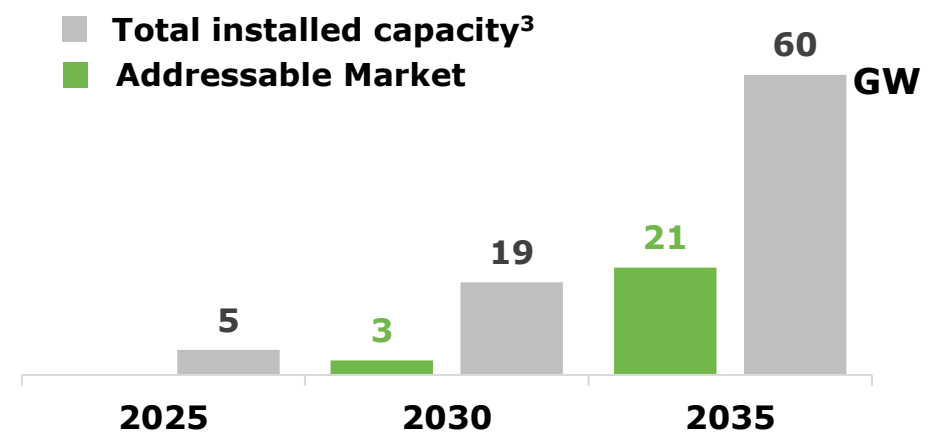

De Nora PIPELINE



1.AWE = Alkaline Water Electrolysis. 2.AEM = Anion Exchange Membrane. 3.Source: Rystad Energy database and company’s analysis. 4. As of March 18, 2026



Circularity

Unlock new markets through sustainable, circular electrochemical solutions

CIRCULARITY

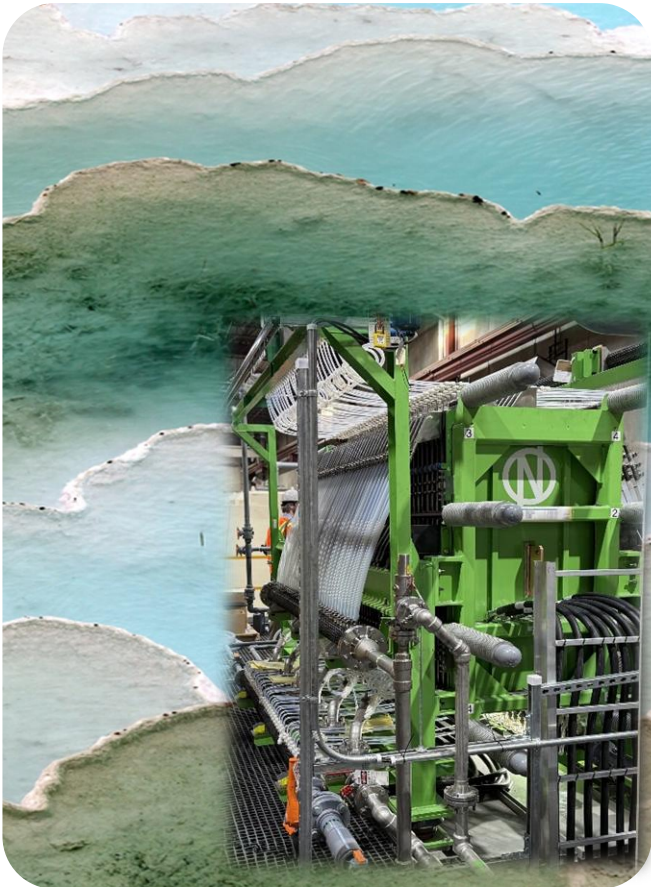

De Nora STRATEGY

E-Chem: a sustainable, circular alternative to traditional processes for new market challenges:
raw materials, CO₂ reduction and electrification

Lithium¹ (LiOH) production:
 Ready-to-deploy solution for refining **LiCl** and **Li₂SO₄** from solar, geothermal brines or spent batteries

Salt Splitting, E-Chem
 solution for recovering valuable chemical materials salt-rich waste streams

MARKET Opportunity

LITHIUM²

n.m.	~\$1 bn	new addressable market LiOH from LiCl brine only
2025	2035	

~\$25 bn	~\$50 bn	2x in 10yrs investments for Lithium production excl. mining
2025	2035	

DE NORA Market Entry 2025 (€11m Backlog)

SALT SPLITTING³

n.m.	~\$800 m	new addressable market Only first identified market
2025	2035	

DE NORA is providing demonstration plants to a large industrial player

1. LiOH = Lithium Hydroxide. LiCl = Lithium Chloride, Li₂SO₄ = Lithium Sulfate. 2. Lithium production opportunity refers to refining from LiCl only. 3. Salt Splitting opportunity refers to a selected confidential market.



Financial framework - Over a 3 to 5 yr cycle

CORE BUSINESS

REVENUES

Annual Organic Growth*

+2% to +4%

ELECTRODE TECHNOLOGIES

Revenues* **stable** to **low single-digit**

Adj. EBITDA margin **19% - 21%**

WATER TECHNOLOGIES

Revenues* **+5%** to **+8%**

Adj. EBITDA margin **17% - 19%**



ENERGY TRANSITION

GREEN HYDROGEN



2.0 GW pipeline
Progressive growth in
Small Scale **Systems**

Progressive growth
**LITHIUM REFINING
PROJECTS**



GROUP PROFITABILITY

ADJ EBITDA MARGIN

Annual range

15% to 19%

(Excluding M&A)

*CAGR



Financial framework - capital allocation priorities

CAPEX
Maintenance Capex / Year

€35 - €40m
(Excluding M&A)

DIVIDEND PAY OUT

UP TO 25%

FCF

POSITIVE
(Excluding M&A)

M&A to power growth



Integrated Business Model:

System Integration, Solution Offering, Engineering and Process capabilities



New Market entry:

Entering in new strategic and growing markets (semiconductors, pharma, critical materials, desalination..) and enhance geographical penetration



Positioning across value chain

Acquiring technologies, key references, and established businesses



Agenda

- De Nora in a Nutshell
- Q1 2026 Business Achievements
- Q1 2026 Financial Results and 2026 Guidance
- Mid-Term View
- **Sustainability Journey**
- Investment case

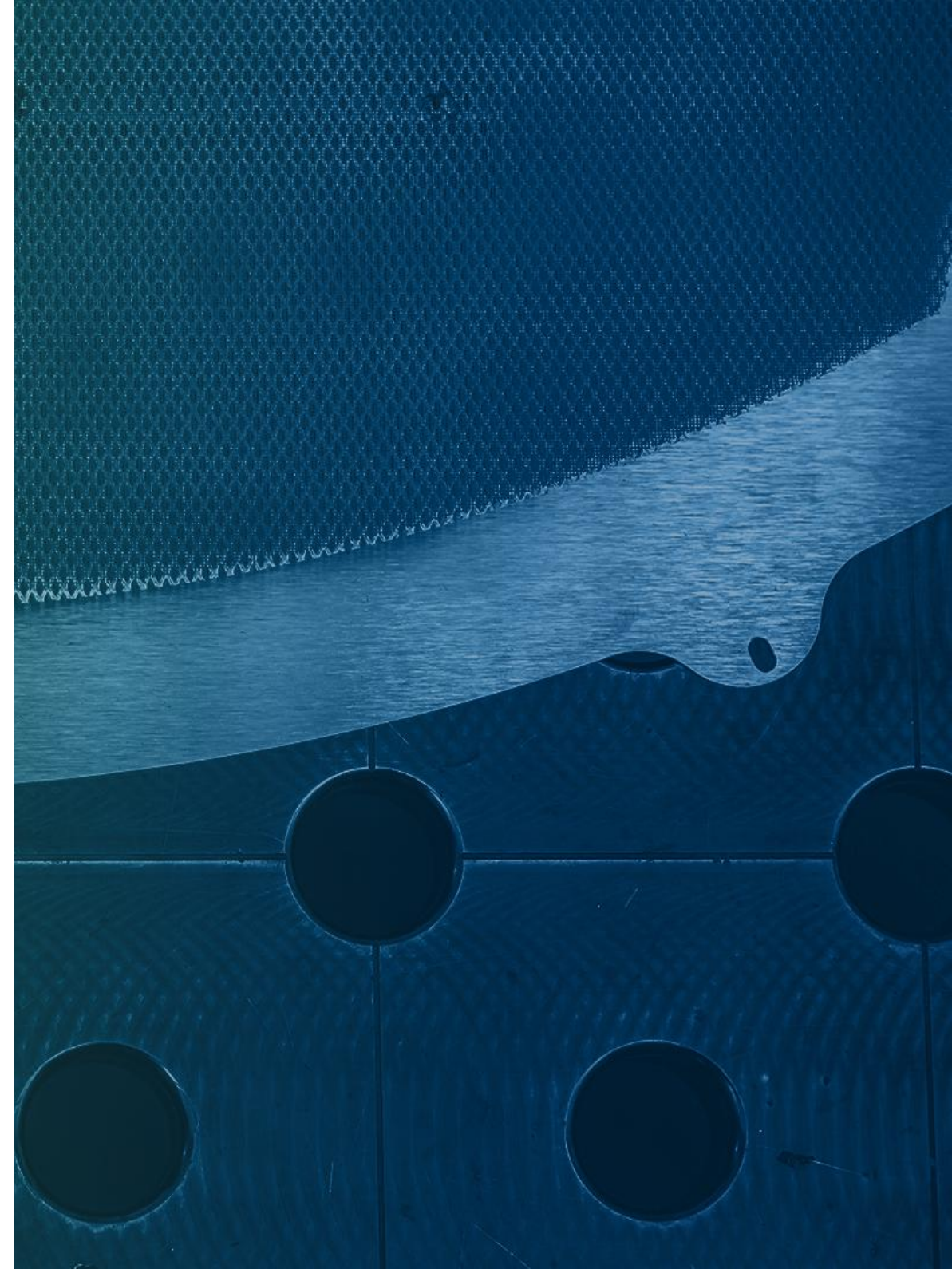



DE NORA

**Sustainable
by Nature**



2030 Sustainability plan

48 Initiatives, o/w 25 completed up to 2025



2025 ESG achievements

Sustainability 2030 plan execution progressing at full pace



GREEN INNOVATION

11

Sustainability Product Scorecard released

100%

Sales people trained on Scorecard

-7.69%

Noble metals reduction in 2025

-4%

Target by 2026 vs 2022



Achieved in advance



CLIMATE ACTION

GHG emission Scope 1 and 2 in 2025

-17% vs 2022

35%

Of electricity used from renewable sources



CIRCULARITY

61%

Waste diverted from disposal in 2025

55%

Target by 2030



Achieved in advance

46%

Wood packaging reused in 2025

40%

Target by 2026



Achieved in advance



PEOPLE

Increase in training hours

+11%

43%

Women in new hires

1%

Gender pay gap



SUPPLY CHAIN & LOCAL COMMUNITIES

46%

Suppliers assessed with ESG criteria

2

Audits on-site

1,480

Volunteering hours

Our positive impact & external recognition

Our Contribution to the UN SDGs

50% Revenues linked to SDGs



1.1m ton CO₂/Y emissions avoided, Green H₂ Techs



246m m3/d WT
13% potable
48m people served

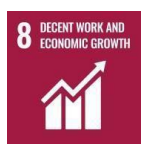

104 k m2 Electrode re-used
16% total production



100% R&D linked to SDGs

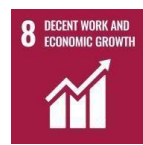

EU Taxonomy

Aligned KPIs (2025)

REVENUES
26%

CAPEX
61%

OPEX
26%

External Recognition



ESG journey...

PV PANELS INSTALLED AT OUR PLANTS WORLDWIDE

Q1 2026
2 new PV facilities
adding **~1.2 GWh/y**

- Okayama, JP
- Suzhou, China

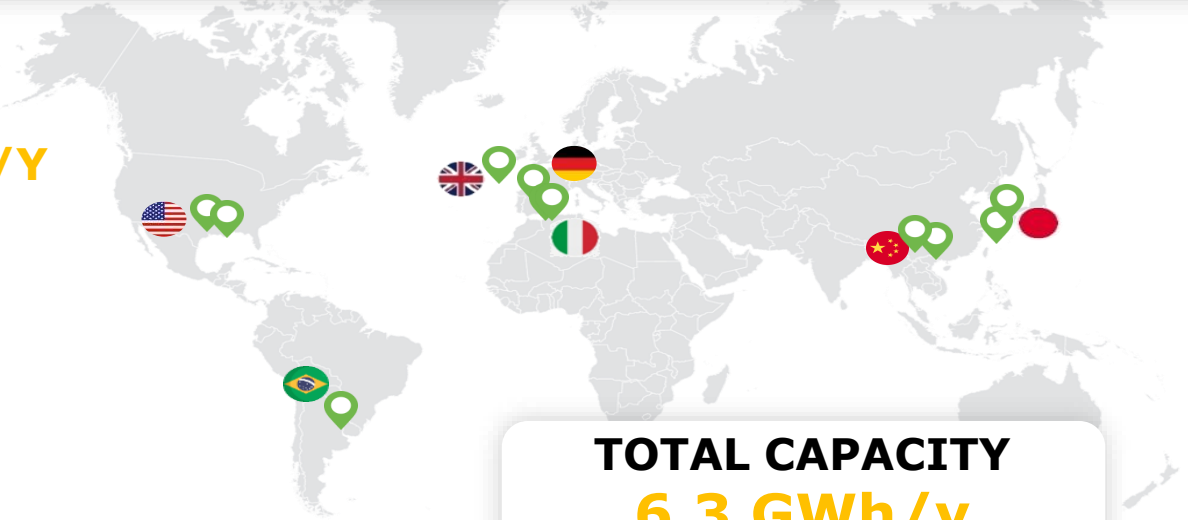

- Colmar, US
- Mentor, US
- Sorocaba, BR
- Rodenbach, DE
- Milano, IT
- Cologno, IT
- Tamworth, UK
- Fujisawa, JP
- Jinan, China

TOTAL CAPACITY
6.3 GWh/y



2025 SUSTAINABILITY STATEMENT

Approved by the Shareholders' Meeting
29° April 2026

ESG 2030 PLAN PROGRESS

48 strategic initiatives

25 completed up to 2025



Agenda

- De Nora in a Nutshell
- Q1 2026 Business Achievements
- Q1 2026 Financial Results and 2026 Guidance
- Mid-Term View
- Sustainability Journey
- **Investment case**

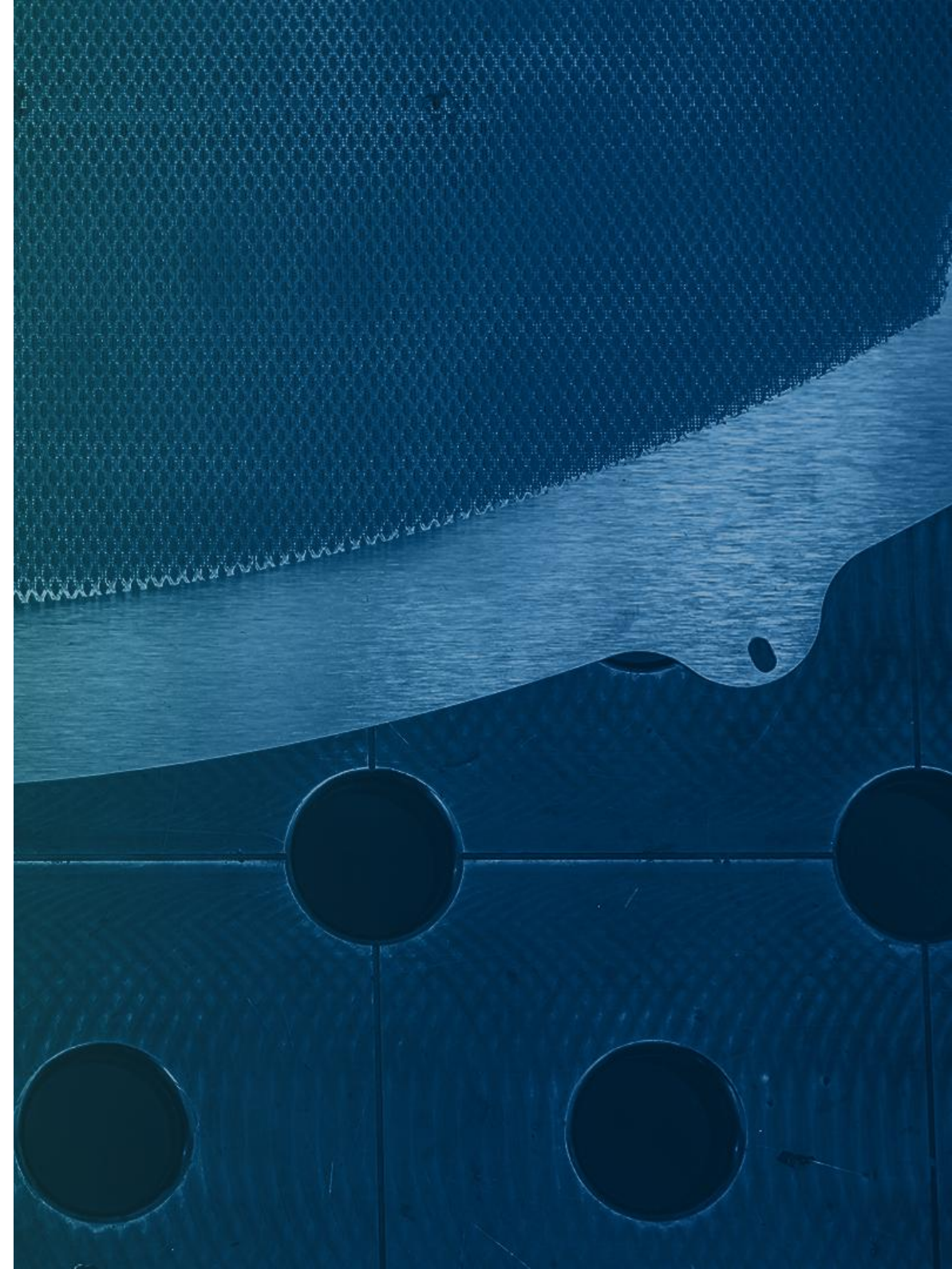

De Nora Investment Case

Leading Innovative Technologies to enable a Sustainable Future



Global Market Leader in coated electrodes and advanced water treatment solutions



Sustainable Innovation & Green Hydrogen Leadership: Cutting-edge technologies shaped by 100+ years of R&D, driving the energy transition and circular economy



Global Footprint & Execution Excellence: Scalable manufacturing footprint and proven delivery capabilities across markets



Trusted Partnerships: Long-standing relationships with top-tier customers and industry leaders



Financial Strength: Solid profitability and capital structure to fuel long-term growth



ESG Commitment: Clear and actionable Sustainability Plan launched in December 2023

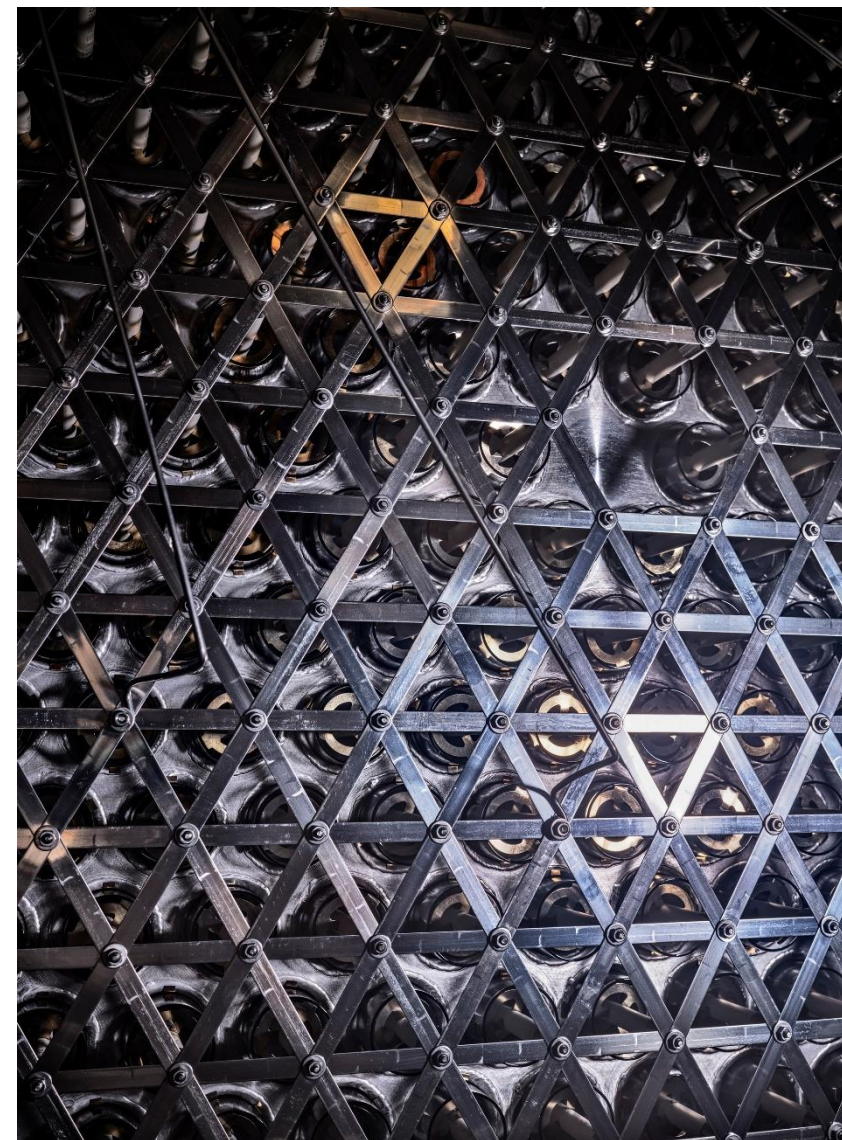

Our ambition

To pioneer clean solutions in water, circularity, hydrogen and electrochemical processes, enabling customers' transition toward sustainable operations.





Additional Materials

DE NORA GOVERNANCE

Stable shareholders' base and solid dividend policy

MAJOR SHAREHOLDERS <i>Data as of 31 Dec. 2024</i>	% SHARES*	% OF VOTING RIGHTS
<i>De Nora Family (ordinary shares)</i>	0.33%	0.13%
<i>De Nora Family (multiple vote shares)</i>	53.02%	63.83%
De Nora Family	53.35%	63.96%
Asset Company 10 S.r.l. (multiple vote shares)	21.59%	25.99%
Management (ordinary shares)	1.29%	0.52%
Treasury shares (ordinary shares)	1.48%	0.59% - suspended
Other Institutional & Retail Investors (ordinary shares)	22.30%	8.94%

DIVIDENDS



€ 89.8 million

Dividends distribution in 2023-2026**



Dividend Policy

up to **25%** Dividend Pay-out (2025-2027 Plan)













~ € 43 million

Buy-back completed in 2023-2024

*% calculated on: total ordinary shares (n. 51,203,979) + multiple vote shares (n. 150,481,195). Multiple vote shares are owned by the shareholders Federico De Nora, Federico De Nora SpA, Norfin SpA, and Asset Company 10 Srl. Multiple-vote shares are not admitted to trading on Euronext Milan and are not counted in the free float and market capitalization value.

** Included Dividend to be approved by the Shareholders Meeting on 29 April 2026.











ESG agenda to 2030 (1/10)

	Initiatives	KPI	Targets (Baseline 2022)	Actual 2025	Progress
Green innovation   	Implementation of Circular Design Guidelines, based on LCA (Life Cycle Assessment), into R&D processes	Guideline adoption	To be embedded in 2024	Guidelines implemented in R&D processes	
	Disclosure and calculation of	% of R&D costs with positive impact on the SDGs	>80% by 2026	100%	
	• R&D expenses with positive impacts				
	• Revenues with positive impacts	% of revenues with positive impact on the SDGs	>50% by 2026	50%	
	Development of a sustainability product scorecard based on LCA and the Circular Design Guidelines	Product scorecard methodology	To be developed in 2024	Methodology developed	
		% of products classified with the scorecard	100% of new products by 2025	100% of new products	
			100% of products by 2027		
Value proposition scorecard					
Employee training	% of employees involved	100% of salespeople by 2025	Training delivered to 100% of salespeople		
Visibility campaign for external stakeholders		50% of white collars by 2026			
Optimization of noble metals within products	t of noble metals / m ² of electrode ¹	-4% by 2026	-7.69%		

¹KPI built on 3 main product lines: Membranes, Pools and Electrochlorination, Alkaline Water Electrolysis



ESG agenda to 2030 (2/10)

Initiatives		KPI	Targets (Baseline 2022)	Actual 2025	Progress
<p>Climate action</p>  	Carbon footprint reduction	Scope 1 and 2 emissions reduction	-50% by 2030 -25% by 2027	-17%	 
	<ul style="list-style-type: none"> Submission to SBTi (in 2024) Development of decarbonization plans for production sites Monitoring of Scope 3 emissions methodology Integration of GHG emission parameters into CAPEX decisions 	Scope 3 emissions reduction	-52% by 2030 (intensity ²)	Intensity on revenues: +3% Intensity on gross profit: +7%	 
		% of electricity from renewable sources	100% by 2030 40% by 2026	35% renewable electricity	 
	Certifications:	ISO 50001 certified sites ³	100% of sites by 2027	3 certified sites	
	<ul style="list-style-type: none"> Energy management systems Environmental management system 	ISO 14001 certified sites ⁴	100% of sites by 2025	100%	







² CO₂ emissions per gross profit

³ The Shotec site is excluded from the KPI, with certification targeted by 2028.

⁴ The Shotec site is excluded from the KPI, with certification targeted by 2028.









ESG agenda to 2030 (3/10)

	Initiatives	KPI	Targets (Baseline 2022)	Actual 2025	Progress
Circular economy  	Group waste management	% of waste diverted from disposal	55% by 2030	61%	
	<ul style="list-style-type: none"> Optimization of waste management Increase in the share of reused wooden packaging 	% of reused wooden packaging	40% by 2026	46%	
	"Deforestation-free" wooden packaging	% of "deforestation-free" wooden packaging	>80% by 2030	Ongoing	
	Increase / disclose the quantity of recycled noble metals ⁵	% of recycled noble metals (by weight)	5% by 2030	1.9% recycled noble metals purchased	
	Strengthen and give visibility to circular services (re-coating)	% of products (in m ² terms) designed for a second life	Disclosure by 2026	Ongoing	

⁵ Recycled metals: metals purchased from suppliers certifying recycled origin. Recovered metals: re-used metals, including following third-party processing, originating from production scrap or collection of used electrodes.











ESG agenda to 2030 (4/10)

	Initiatives	KPI	Targets (Baseline 2022)	Actual 2025	Progress
Biodiversity  	Mapping of ecological zones for biodiversity purposes	Analysis	Mapping in 2024	Mapping completed	
	Monitoring and optimization of water use at production sites, starting from those in water-stressed areas	KPI selection in progress	Assessment starting from 2025	Assessment completed	
	Environmental Emergency Plan for production sites	Analysis and document drafting	2024	Environmental Emergency Plans developed for production sites	
	Participation in partnerships / initiatives supporting biodiversity	# plants / avoided emissions		Ongoing collaboration with Treadom	
	CDP Water and CDP Forest questionnaire	Submission and disclosure ⁶	2026	CDP Water completed	

⁶ Following the biodiversity analysis performed in 2024, the Company decided not to pursue the completion of CDP Forest because the topic is not material.













ESG agenda to 2030 (5/10)

	Initiatives	KPI	Targets (Baseline 2022)	Actual 2025	Progress
Employee Health & Safety 	Development of governance and culture related to Health & Safety	No. of plants with gemba walks	All plants by 2025	100% plants	
	<ul style="list-style-type: none"> Periodic "gemba walks" at plants Periodic H&S reports Organize Safety Days at plants 	Report frequency	Quarterly reports	Reports implemented	
		No. of plants with safety days	All plants by 2025	100% plants	
	Mental health awareness	% of employees for basic module	25% by 2026	Course assigned to 100% of employees	
	<ul style="list-style-type: none"> Introduction of mental health training module Introduction of mental health first-aid training Implementation of a hotline or other support channels 	No. of employees for first-aid training	1 person for each relevant site ⁷ by 2026	Ongoing	
		# territories	100% by 2026	Ongoing	
	Certifications	ISO 45001 certified sites	100% by 2025	100%	

⁷ Dubai, Abu Dhabi, India, Shanghai, Suzhou and Jinan.









ESG agenda to 2030 (6/10)

	Initiatives	KPI	Targets (Baseline 2022)	Actual 2025	Progress
Employee Diversity, Equity & Inclusion   	Extension of the parental and relocation policy to same-sex partners and single parents		2024	Policy updated and extended as planned	
	Monitor the Gender Pay Gap calculation methodology, and 0 gender pay gap in hiring	Gender Pay Gap		1%	
	Affinity network for women and LGBTQ+ employees in all geographies		Launched in 2024	3 initiatives in Italy, USA and Brazil	
	Strengthen recruitment processes for the inclusion of candidates with disabilities	No. of territories completing the review	100% by 2026	Ongoing	
	Internal and external DE&I communication campaigns with success stories	No. of stories per year	4-8 (at least 1 per quarter)	4 episodes published on We are De Nora	
	Adoption of a DE&I policy	Policy adoption	2024	Policy adopted	
	Disclosure on % of women among new hires (white collar, non-manufacturing)	% of women among new hires (white collar)	>40% in the 2025-2027 period	43% in 2025	
	Upskilling, networking and mentoring programs dedicated to women, including through networking with associations (Valore D.)			In.C.L.U.De program aimed at inclusive leadership training • Second edition in Italy • First edition in Germany, Japan, UAE and UK	



ESG agenda to 2030 (7/10)









	Initiatives	KPI	Targets (Baseline 2022)	Actual 2025	Progress
Community engagement   	Disclosure on expenditure for local communities	Expenditure dedicated to local communities (euro)	Disclosure from 2024	€ 236,290	
	Employee engagement	Hours donated / year		1480 hours of volunteering	
	<ul style="list-style-type: none"> • Launch of employee donation initiatives • Promotion of participation in local and charitable events across all geographies 				
	Educational partnerships to support the development of STEM careers and strengthen the future talent pipeline.	% of female students involved in DEI events ^a (between 2 and 5 events per year)	>40% (2026)	45% in 4 events	
	Visits to laboratories and plants, professional lectures and problem-solving training	# Students involved	>20 per site ^b / year by 2026	+300 students involved	

^a In 2025 the KPI was further defined and contextualized to ensure consistency with project objectives.

^b Sites with more than 100 employees.





ESG agenda to 2030 (8/10)

	Initiatives	KPI	Targets (Baseline 2022)	Actual 2025	Progress
Responsible Supply Chain 	Disclosure of the percentage of local expenditure for suppliers	% of local supplier expenditure	Disclosure of the data	67%	
	Internal awareness campaign focused on sustainable Supply Chain management	Internal communication event	2025	Awareness campaign carried out	
	Assessment of supplier sustainability	% of suppliers assessed (selected based on spend)	>50% of suppliers by 2030	46% suppliers assessed	
	<ul style="list-style-type: none"> Platform upgrade for supplier analysis Development of the percentage of suppliers assessed according to ESG criteria 		>25% of suppliers ¹⁰ by 2026		
	Inclusion of ESG requirements in procurement processes, rewarding sustainable suppliers	To be defined	2026	Ongoing	
	Supplier engagement	% of high-risk suppliers engaged	100% by 2026	Mapping of high-risk suppliers completed	
	<ul style="list-style-type: none"> Engagement of highest-risk suppliers Training for selected suppliers (e.g. SMEs) Organization of audits for high-risk suppliers 	No. of suppliers audited	2 in 2025 (pilot)	2 audits completed	

¹⁰ Considering as the basis for the percentage a set of suppliers representing around 80% of total spend.











ESG agenda to 2030 (9/10)

	Initiatives	KPI	Targets (Baseline 2022)	Actual 2025	Progress
Product Quality & Safety 	Harmonization of the methodology for managing product complaints and recalls		By 2026	Harmonization completed	
	Customer satisfaction targets across the Group (Net Promoter Score)	Net Promoter Score	NPS across the Group by 2025	NPS implemented	
	ISO 9001 certification (Quality Management)	Certified sites	100% of certified sites by 2025	100%	



ESG agenda to 2030 (10/10)

	Initiatives	KPI	Targets (Baseline 2022)	Actual 2025	Progress
Governance Business Ethics 	Adoption of Human Rights policy	Policy adoption	To be published in 2024	Policy adopted	
	Monitoring for the anti-corruption policy		Implementation by 2026	Adopted in Italy, Germany, UK and Middle East	
	Training in all geographies to address local specificities	% of white collars who completed the training	100% by 2026	Training delivered in UK, Brazil, China and Japan	
	Adoption of regional guidelines for Export Control and economic activities	% of countries/regions that adopted the guidelines	100% by 2026	Guidelines adopted in 4 countries	
	Disclosure relating to Conflict Minerals regulation		2024	Issued in the new Supply Chain Policy	
	Disclosure relating to Critical Raw Materials regulation		2026	Ongoing	
	Executive manager remuneration linked to ESG targets	% target MBO e PSP ¹¹	20% - CEO 10%+ Strategic Executives	20% - CEO 10%+ Strategic Executives	

¹¹ Performance Shares Plan.



Income Statements

(€m)	Q1 2025	Q2 2025	H1 2025	Q3 2025	9M 2025	Q4 2025	FY 2025	Q1 2026
Revenue	200.4	215.2	415.6	215.7	631.3	243.7	875.0	178.5
YoY Growth (%)	6.0%	1.9%	3.8%	7.4%	5.0%	-6.8%	1.4%	-10.9%
Royalties and commissions	(1.8)	(2.0)	(3.8)	(1.6)	(5.4)	(3.5)	(8.9)	(1.3)
Cost of goods sold	(129.5)	(139.9)	(269.4)	(139.4)	(408.8)	(153.6)	(562.4)	(110.4)
Selling expenses	(8.0)	(8.0)	(16.0)	(8.0)	(24.0)	(7.9)	(31.9)	(7.4)
G&A expenses	(12.8)	(12.8)	(25.6)	(12.6)	(38.2)	(13.9)	(52.1)	(12.1)
R&D expenses	(3.0)	(2.7)	(5.7)	(3.0)	(8.7)	(5.8)	(14.5)	(1.8)
Other operating income (expenses)	(0.4)	2.7	2.3	-	2.3	(1.4)	0.9	(0.9)
Corporate costs	(8.9)	(9.7)	(18.6)	(8.6)	(27.2)	(14.7)	(41.9)	(10.0)
EBITDA	36.0	42.8	78.8	42.5	121.3	42.9	164.2	34.6
Margin (%)	18.0%	19.9%	19.0%	19.7%	19.2%	17.6%	18.8%	19.4%
Depreciation and amortization	(9.1)	(8.8)	(17.9)	(8.8)	(26.7)	(9.0)	(35.7)	(8.2)
Impairment	-	-	-	0.1	0.1	0.2	0.3	-
EBIT	26.9	34.0	60.9	33.8	94.7	34.1	128.8	26.4
Margin (%)	13.4%	15.8%	14.7%	15.7%	15.0%	14.0%	14.7%	14.8%
Share of profit of equity-accounted investees	-	(0.8)	(0.8)	(0.4)	(1.2)	(0.7)	(1.9)	-
Net Finance income / (expenses)	(2.2)	(4.3)	(6.5)	(0.5)	(7.0)	(1.3)	(8.3)	(0.7)
Profit before tax	24.7	28.9	53.6	32.9	86.5	32.1	118.6	25.7
Income taxes	(8.7)	(9.4)	(18.1)	(8.0)	(26.1)	(9.8)	(35.9)	(7.7)
Net Result	16.0	19.5	35.5	24.9	60.4	22.3	82.7	18.0



Quarterly Revenues and adj. EBITDA by BU

(€m)	Q1 '25	Q2 '25	Q3 '25	Q4 '25	Q1 '26	Q1 '25 vs Q1 '26
REVENUES	200.4	215.2	215.7	243.7	178.5	-10.9%
Electrode Technologies	106.8	114.7	105.2	110.4	85.6	-19.9%
Energy Transition	17.7	25.5	35.0	33.7	8.0	-54.8%
Water Technologies	75.9	75.0	75.5	99.6	84.9	11.9%
EBITDA Adj.	39.4	42.0	43.0	47.4	36.0	-8.6%
EBITDA Adj. Margin	19.7%	19.5%	19.9%	19.5%	20.2%	
Electrode Technologies	24.0	23.4	21.0	19.3	17.5	-27.1%
<i>Ebitda Adj. Margin</i>	22.5%	20.4%	20.0%	17.5%	20.4%	
Energy Transition	(1.8)	2.9	5.5	8.7	(3.4)	88.9%
<i>Ebitda Adj. Margin</i>	-10.2%	11.4%	15.7%	25.8%	-42.5%	
Water Technologies	17.2	15.7	16.5	19.4	21.9	27.3%
<i>Ebitda Adj. Margin</i>	22.7%	20.9%	21.9%	19.5%	25.8%	



Income Statement

Focus on EBITDA adjustments

(€m)	Q1 2025	Q1 2026
Sales	200.4	178.5
EBITDA	36.0	34.8
Margin (%)	18.0%	19.5%
Termination costs (labor + legal expenses)	0.1	-
GF Revenues related to IPCEI eligible cost	-	(1.2)
IPCEI GF Eligible costs (net of grant)	0.2	1.3
Costs for M&A, integration, and company reorganization	0.5	0.9
Marine business divesture	0.7	-
Fracking business divesture	0.2	-
Other non-recurring provision (tax)	1.5	-
Other non-recurring costs	0.2	0.2
Adj. EBITDA	39.4	36.0
Margin (%)	19.7%	20.2%



Balance Sheet Q1 2026

(€m)	Q1 2025	Q1 2026
Intangible assets	103.4	101.4
Property, plant and equipment	321.7	315.6
Equity-accounted investees	232.7	232.7
Fixed asset	657.9	649.7
Inventories	278.6	214.4
Contract work in progress, net of advances from customers	34.2	32.4
Trade receivables	163.9	152.9
Trade payables	(87.7)	(113.5)
Operating working capital	389.0	286.3
Other current assets and liabilities	(18.8)	(18.7)
Net working capital	370.1	267.6
Deferred tax assets	13.6	13.3
Other receivables and non-current financial assets	10.5	10.1
Employee benefits	(24.1)	(24.7)
Provisions for risks and charges	(21.4)	(24.4)
Deferred tax liabilities	(4.9)	(4.9)
Trade payables	(0.1)	(0.1)
Other payables	(3.3)	(2.6)
Other net non current asset and liabilities	(29.7)	(33.3)
Net invested capital	998.3	884.0
Net current Liquidity / (Financial Indebtedness)	20.9	105.6
Non-current Financial Indebtedness	(18.4)	(18.8)
Net Liquidity / (Financial Indebtedness) - ESMA	2.5	86.7
Fair value of financial instruments	0.0	(0.1)
Net Liquidity / (Financial Indebtedness) - De Nora	2.5	86.6
Total Equity	(1,000.8)	(970.6)
Total sources	(998.3)	(884.0)



Balance Sheet FY 2025

(€m)	FY 2024	FY 2025
Intangible assets	116.0	101.4
Property, plant and equipment	291.8	315.6
Equity-accounted investees	236.8	232.7
Fixed asset	644.5	649.7
Inventories	255.5	214.4
Contract work in progress, net of advances from customers	36.4	32.4
Trade receivables	173.5	152.9
Trade payables	(116.8)	(113.5)
Operating working capital	348.6	286.3
Other current assets and liabilities	(78.2)	(18.7)
Net working capital	270.3	267.6
Deferred tax assets	15.5	13.3
Other receivables and non-current financial assets	11.4	10.1
Employee benefits	(25.9)	(24.7)
Provisions for risks and charges	(19.9)	(24.4)
Deferred tax liabilities	(6.0)	(4.9)
Trade payables	-	(0.1)
Other payables	(2.9)	(2.6)
Other net non current asset and liabilities	(27.8)	(33.3)
Net invested capital	887.0	884.0
Net current Liquidity / (Financial Indebtedness)	207.7	105.6
Non-current Financial Indebtedness	(140.6)	(18.8)
Net Liquidity / (Financial Indebtedness) - ESMA	67.1	86.7
Fair value of financial instruments	(0.3)	(0.1)
Net Liquidity / (Financial Indebtedness) - De Nora	66.8	86.6
Total Equity	(953.8)	(970.6)
Total sources	(887.0)	(884.0)



Cash Flow Statement

(€m)	Q1 2025	Q1 2026
EBITDA	34.8	36.0
Losses on the sale of property, plant and equipment and intangible assets	0.0	(0.8)
Other non-monetary items	(1.2)	0.5
Cash flows generated by operating activities before changes in net working capital	33.6	35.6
Change in inventory	(60.5)	(7.9)
Change in trade receivables and construction contracts	(8.9)	(1.5)
Change in trade payables	(26.9)	(29.0)
Change in other receivables/payables	(5.5)	(9.9)
Cash flows generated by changes in net working capital	(101.8)	(48.2)
Cash flows generated by operating activities	(68.2)	(12.6)
Net Interest and Net other financial expense paid	(1.5)	0.9
Income taxes paid	(5.1)	(14.8)
Net cash flows generated by operating activities	(74.8)	(26.4)
Sales of property, plant and equipment and intangible assets	0.2	1.0
Investments in tangible and intangible assets	(11.1)	(12.7)
(Investments) Divestments in financial activities	3.9	0.6
Net cash flows used in investing activities	(7.0)	(11.0)
Share capital increase	1.0	0.8
New loans/(Repayment) of loans	54.5	1.9
Net cash flows generated by financing activities	55.5	2.7
Net increase (decrease) in cash and cash equivalents	(26.3)	(34.8)
Opening cash and cash equivalents	109.1	215.9
Exchange rate gains/(losses)	1.3	(2.0)
Closing cash and cash equivalents	84.0	179.1



FY 2025 Revenues

Growth driven by Water and Energy Transition

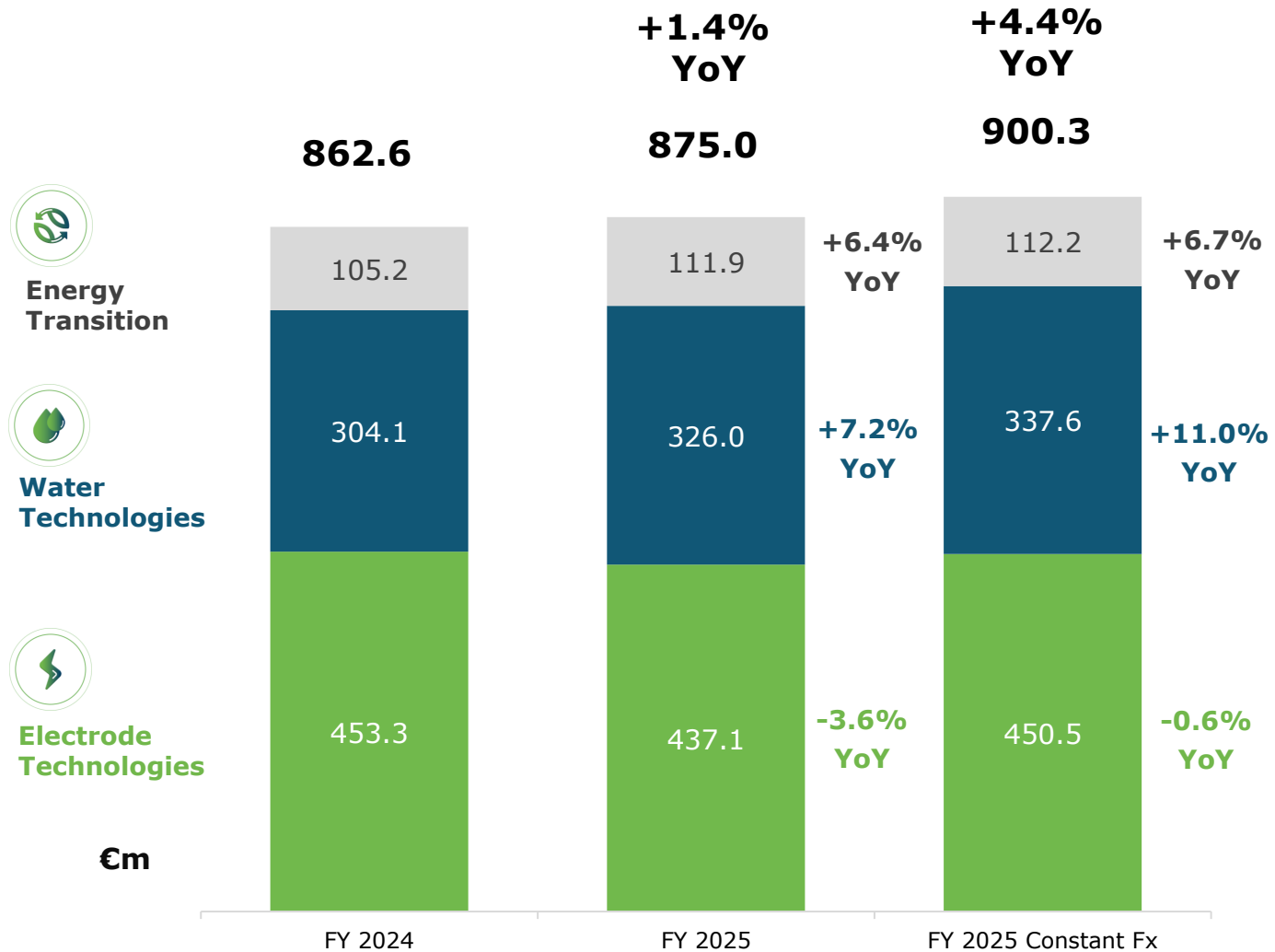

Revenues By Geography

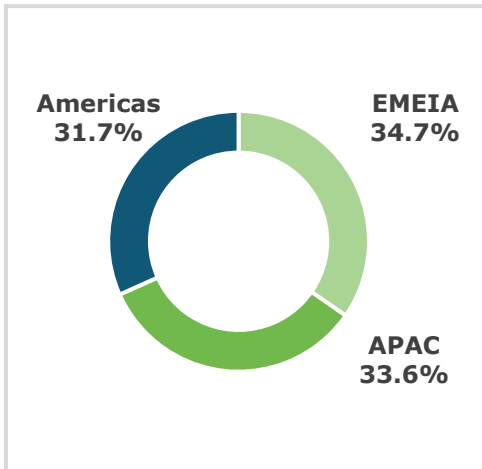

Revenues By Type

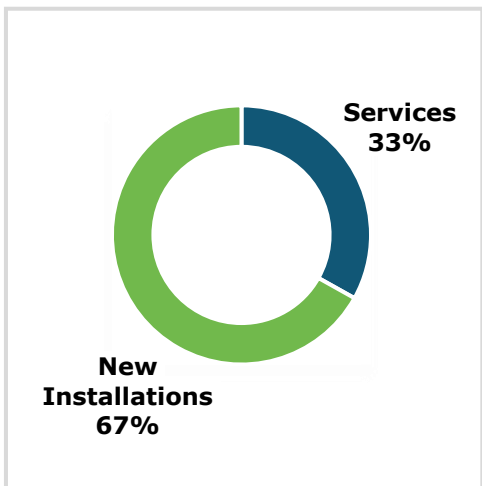

KEY HIGHLIGHTS

ELECTRODE TECHNOLOGIES

- **10.4%** growth in **Electronics**, overall stability in **Chlor-Akali**, and a decline in Electrowinning
- Net of FX effect, Revenues were stable
- Aftermarket Revenues at **46%**

WATER TECHNOLOGIES

- **Pools +27.5%** YoY, driven equally by price and volume
- **WTS¹ +3%** net of Marine Business disposal² and FX effects
- **WTS Aftermarket** revenues **42%**

ENERGY TRANSITION

- Growth reflects **Neom** and **Stegra** project execution

1.WTS: Water Technologies Systems. 2. €4.5m due to Marine Business Disposal



Adjusted Ebitda FY 2025

Growth above the guidance, boosted by Water and Energy Transition

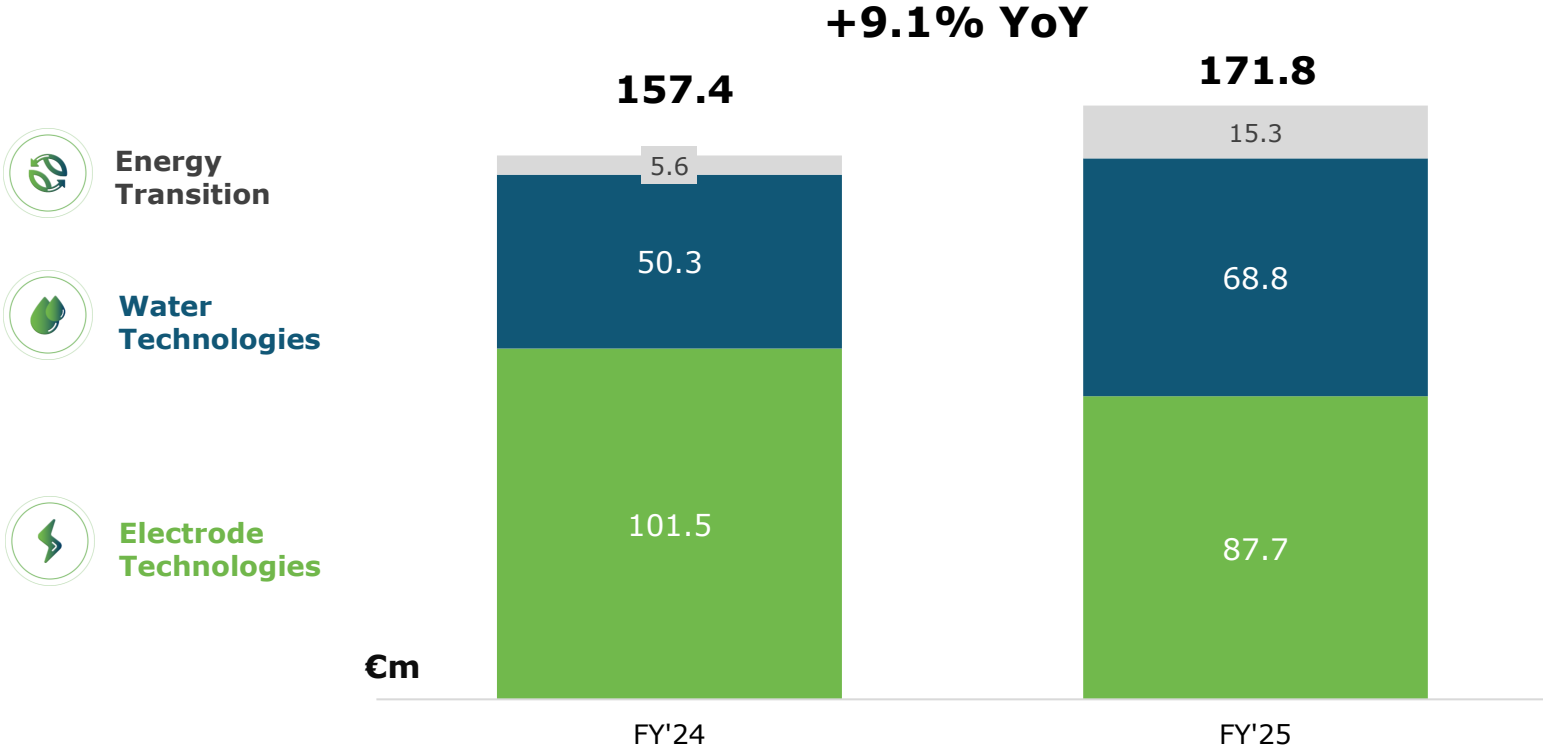

	FY'24	FY'25
Adj. EBITDA* Margin	18.2%	19.6%
<i>Electrode Technologies</i>	22.4%	20.1%
<i>Water Technologies</i>	16.5%	21.1%
<i>Energy Transition</i>	5.3%	13.7%

KEY HIGHLIGHTS

ELECTRODE TECHNOLOGIES

- Performance is mainly driven by the product mix, particularly by the softer electrowinning trend

WATER TECHNOLOGIES

+37% Adj EBITDA underpinned by:

- **Pools** line expansion
- **WTS** aftermarket revenue increase

ENERGY TRANSITION

- **2.5x** profitability mainly due to increased operational efficiency



Thanks

IR CONTACTS

ir@denora.com

[Investor Relations](#) | [Overview](#) | [De Nora](#)

