

# Product Overview

## Heat Treatment Furnaces for Steel and Aluminium Industry



Aichelin

Safety Always

Reliability at Work

Customised Solutions

# Efficient Plants and Advance Solutions for Heat Treatment

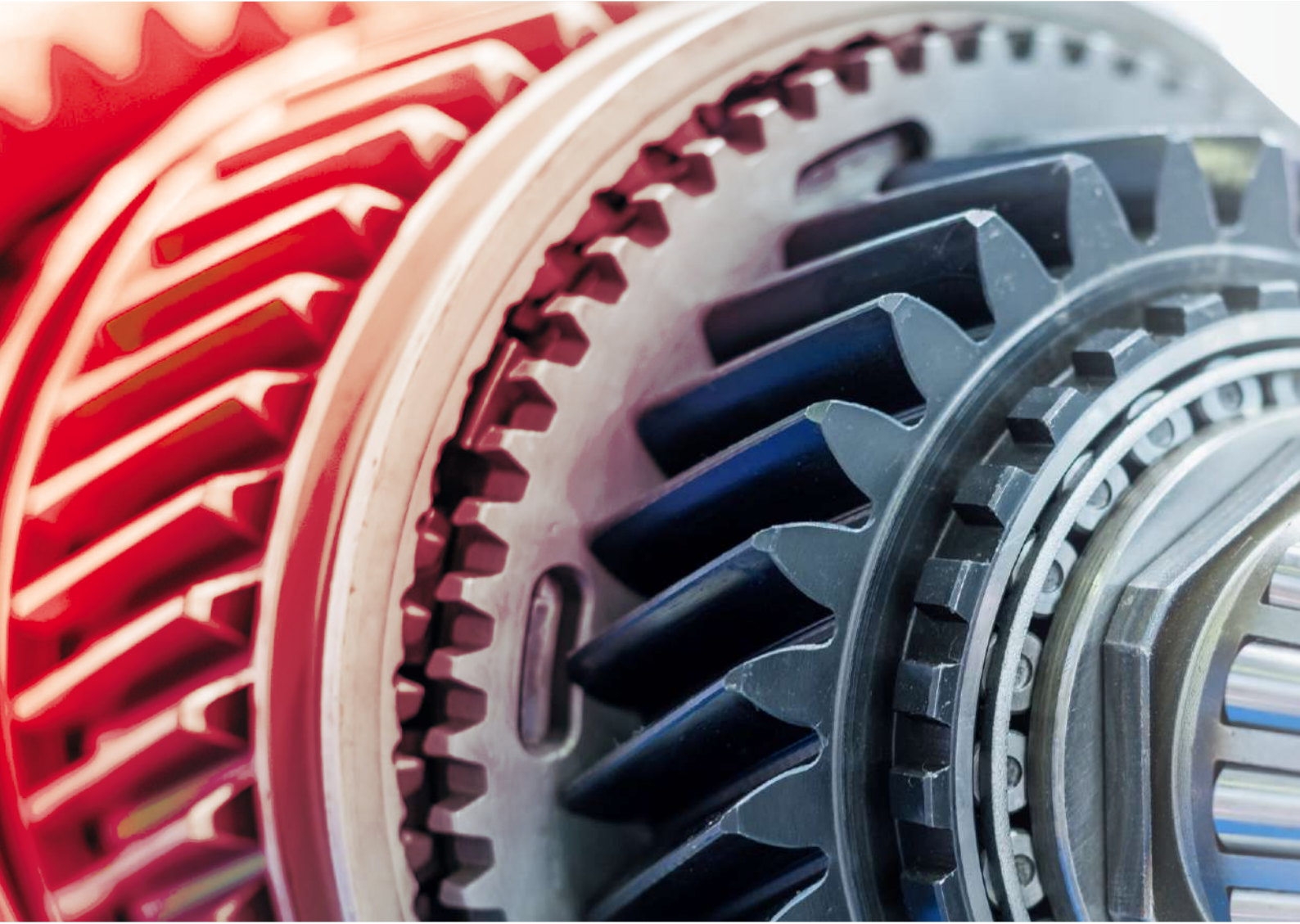

## CONTENT

▪ Introduction to Aichelin Unitherm	1
▪ Heat Treatment All Over the World	2
▪ Multi Purpose Single Chamber Sealed Quench Furnace	3
▪ Multi Purpose Double Chamber Sealed Quench Furnace	5
▪ Continuous Pusher Furnace	7
▪ Mesh Belt Furnace T-Series with Muffle	9
▪ Mesh Belt Furnace TC-Series without Muffle	10
▪ Roller Hearth Furnace	11
▪ Rotary Hearth Furnace	12
▪ Gas Nitriding Furnace with Retort	13
▪ Pit Type Furnace	14
▪ Chamber Washing Machine (KEKTE)	15
▪ FLEXICLEAN® Vacuum Washing Machine	16
▪ Heat Treatment Furnace for Aluminium Industry	17
▪ Vertical Bottom Drop Furnace for Aluminium Industry	18
▪ Bogie Hearth Furnace for Steel Industry	19
▪ Endo Gas Generator	20
▪ Manufacturing Plant	21
▪ Our Customers Our Pride	22
▪ AICHELIN Group	23
▪ UNITHERM Group	24

# Introduction

AICHELIN UNITHERM HEAT TREATMENT SYSTEMS INDIA PVT. LTD. is India's technological leader in the manufacturing of industrial plants and components for the thermal and thermochemical heat treatment of metallic parts.

AICHELIN UNITHERM is a 50:50 joint venture company (JVC) between AICHELIN Holding GmbH (Austria) and UNITHERM Engineers Limited (India). It manufactures state-of-the-art heat treatment furnaces for both domestic and international markets, with a manufacturing plant located in Pune, India.

With its strategic partnership with the AICHELIN Group (a leading European heat treatment solutions provider) over a short period of time, AICHELIN UNITHERM has strengthened its market position as one of India's largest heat treatment companies. It offers a wide range of heat treatment furnaces such as Sealed Quench Furnaces, Continuous Pusher Furnaces, Continuous Mesh Belt Furnaces, Roller Hearth Furnaces, Rotary Hearth Furnaces, Gas Nitriding Furnaces, Pit Furnaces, Washing Machines, Endo Gas Generators and more.

In the field of aluminium heat treatment industry, AICHELIN UNITHERM have supplied T6 furnaces and have the know-how from its group company AFC HOLCROFT USA (part of the AICHELIN Group) to manufacture these furnaces in India.

For the steel industry AICHELIN UNITHERM will provide state-of-the art high temperature and large capacity heat treatment furnaces which will be manufactured in India based on the know-how and design from BOSIO (part of the AICHELIN Group).

To cater to the steel industry, AICHELIN UNITHERM also has co-operation with a local partner in India to offer economical Bogie Hearth and Box Type furnaces based on proven design and technical know-how.

## Vision

"AICHELIN UNITHERM will be the leading and most reliable partner for our customers by providing Industrial Heat Treatment plants and services in India and Overseas."

## Mission

- We as AICHELIN UNITHERM are committed to customer satisfaction by offering reliable products and services at competitive prices.
- We offer high quality furnace equipment and fulfill the customer demands through continuous improvements, cost effectiveness and engaging qualified suppliers as partners.
- We commit to provide outstanding support and service.
- We encourage team integration and empower our employees through individual growth opportunities.
- We will grow through effective customer engagement and technological advancements.

# We Contribute to Heat Treatment All Over the World

At AICHELIN UNITHERM, we deliver reliable, efficient, safe and customised heat treatment solutions built to meet your requirements. Backed by the globally renowned AICHELIN Group (Austria) and over years of experience, we offer best in the class technology, localised service and unmatched industry expertise.

## **RELIABILITY**

Our furnaces are built for long-term performance with least lifetime operational costs ensuring maximum uptime and minimal risks in challenging heat treatment environments with reliability and repeatability of heat treatment results.

## **SAFETY FIRST**

Safety is of the utmost importance, especially in the heat treatment industry. This is where our furnace design stands out from the competition without compromising on any operational safety standards.

## **CUSTOMISED HEAT TREATMENT SOLUTIONS**

We design and manufacture tailor-made heat treatment solutions to meet your specific process requirements, from carburising and hardening to nitriding, also heat treatment solutions for aluminium and steel industry.

## **COMPREHENSIVE PRODUCT RANGE**

From various batch and continuous furnaces to gas generators and automation solutions – our product portfolio covers all your heat treatment needs under one roof.

## **PROVEN GLOBAL TECHNOLOGY INTEGRATION**

Combining European technology with Indian engineering capability, we bring the best of global heat treatment solutions into your plant for your growth. Heat treatment in our furnaces makes the world safer by ensuring durability and reliability of components that go into various engineering products.

## **ENHANCED OPERATIONAL EFFICIENCY**

Our furnaces are highly energy-optimized and Industry 4.0 ready, helping you achieve better throughput process, control and cost efficiency.

## **STRONG DOMESTIC and INTERNATIONAL PRESENCE**

With 500+ of installations across India, Middle East and Southeast Asia, we are a preferred partner to OEMs, Tier-1 suppliers and engineering leaders.

## **BEST-IN-CLASS SALES and SERVICE SUPPORT**

Our dedicated and highly experienced sales and service teams operate from multiple locations across India, ensuring quick response, spare part availability and long-term customer success.

# Multi-Purpose Single Chamber Sealed Quench Furnace

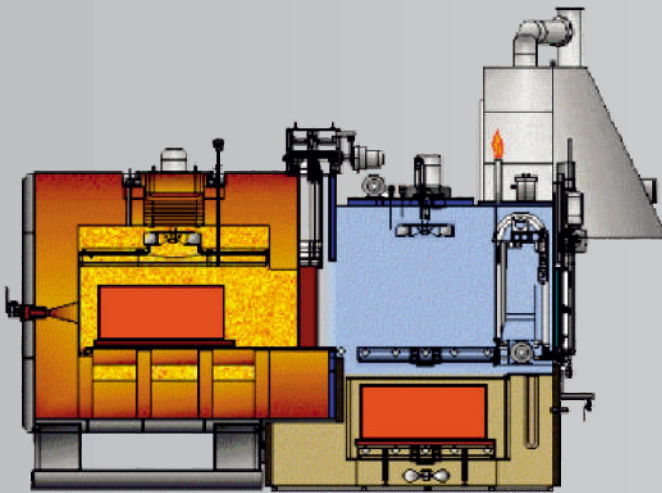

In-Out Design

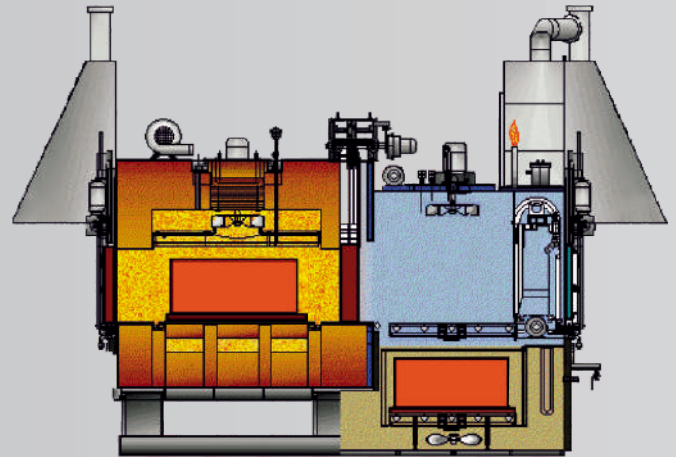

Straight Through Design

## HEAT TREATMENT PROCESS

For carburising, case hardening, carbonitriding, through hardening, normalising, annealing processes.

## MAIN CHARACTERISTICS

- In-Out Design / Straight Through Design.
- Electric / Gas heated options available.
- Designed on principle of no compressed air and no cooling water.
- All electromechanical drives for doors, elevator and charge machine.
- No moving part in heating chamber apart from re-circulation fan.
- Re-circulation fan coupled with standard motor, fan housing is oil cooled closed circuit Siphon design.
- Silicon Carbide skids in heating chamber.
- Silicon Carbide muffle in heating chamber for uniform temperature and atmosphere distribution (optional).
- High uniformity and reproducibility of heat treatment results.
- Temperature uniformity better than  $\pm 5^{\circ}\text{C}$ .
- Carbon potential control  $\pm 0.02\%$  during carburising through motorised valve in enriching line.
- Furnace atmosphere : Endo Gas / Methanol / N<sub>2</sub>
- Enriching gas : LPG / Propane / Natural Gas.
- Quench oil volume ratio as per customer requirement (Minimum - 1:8).
- HYPER Quench: The quench oil agitation system has draft tube which diverts the quench oil in the closed oil guide box surrounding the charge which ensures pressurised and uniform oil flow circulation throughout the charge during quenching. The propeller diameter is 325 mm driven by 5.5/7.5 kW motors through VFD with 2/4 nos. agitators depending upon the size of furnace.
- Sealed Oil Quench or Sealed Salt Quench.
- Fully automatic operation through PLC, HMI and latest process control systems.
- Fully Automatic no man operation plants through **iFACE** (intelligent Fully Automatic Controlled Equipment)
- Gross Capacities : 350 to 2500 kg / batch.



**STANDARD SIZES FOR SQF LINE**

Type	Useful Charge Dimensions W x H x L (mm)	Useful Charge Volume (m <sup>3</sup> )	Gross Charge Weight (kg)	Heating Power (kW)
2	500 x 650 x 900	0.3	350	72
3	600 x 650 x 1200	0.47	650	90
4/2(M)	700 x 850 x 1300	0.77	1000	162
4/2	760 x 850 x 1300	0.84	1000	162
5/2(M)	900 x 850 x 1300	0.99	1200	162
5/2(M)	900 x 900 x 1300	1.05	1500	162/180
5/2	900 x 850 x 1500	1.15	1500	162/180
5/2(M)	900 x 900 x 1500	1.21	1800	210
5/3	900 x 1300 x 1500	1.76	2000/2500	270
6/3	1200 x 900 x 1500	1.62	2000/2500	270

**SPECIAL SIZES FOR SQF LINE**

Type	Useful Charge Dimensions W x H x L (mm)	Useful Charge Volume (m <sup>3</sup> )	Gross Charge Weight (kg)	Heating Power (kW)
5/4	900 x 850 x 1800	1.37	1800	210
5/5	900 x 850 x 2250	1.72	2500	270

# Multi-Purpose Double Chamber Sealed Quench Furnace

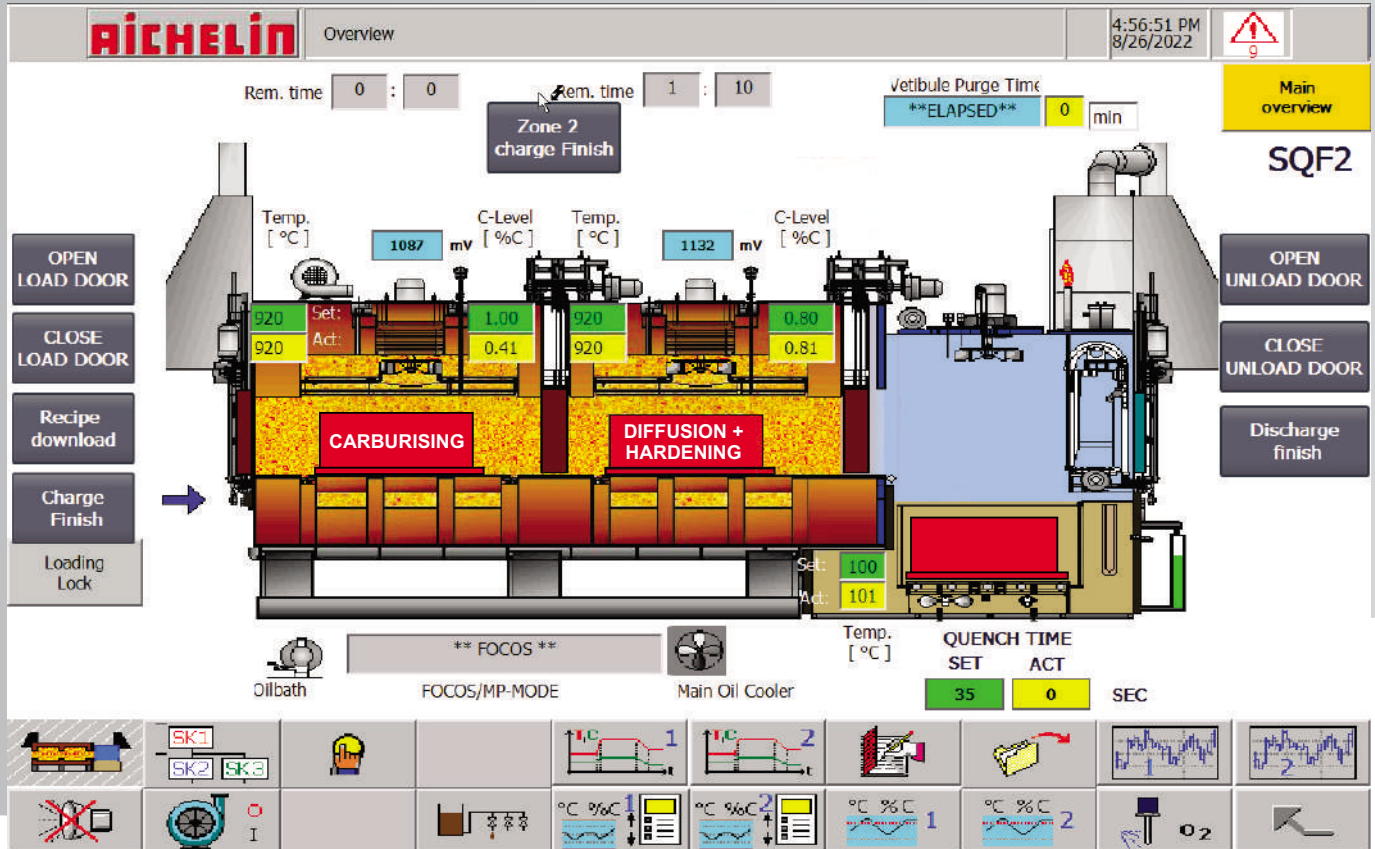

## HEAT TREATMENT PROCESS

For carburising, case hardening, carbonitriding, through hardening, normalising, annealing processes.

## MAIN CHARACTERISTICS

- Straight Through Design.
- Electric / Gas heated options available.
- For high throughput plants.
- Compact design with two heating chambers and common quench tank.
- Savings in connected load, running cost and space.
- Designed on principle of no compressed air and no cooling water.
- All electro-mechanical drives for doors, elevator and charge machine.
- No metallic moving part in heating chamber apart from re-circulation fan.
- Re-circulation fan coupled with standard motor, fan housing is oil cooled closed circuit Siphon design.
- Silicon Carbide skids in heating chambers.
- Silicon Carbide muffle in heating chambers for uniform temperature and atmosphere distribution.
- Temperature uniformity better than +/- 5°C.
- Carbon Potential control +/- 0.02% during Carburising through motorised valve in enriching line.
- Furnace atmosphere : Endo Gas / Methanol / N2
- Enriching gas : LPG / Propane / Natural Gas.
- Quench oil volume ratio as per customer requirement (Minimum - 1:8).
- HYPER Quench: The quench oil agitation system has draft tube which diverts the quench oil in the closed oil guide box surrounding the charge which ensures pressurised and uniform oil flow circulation throughout the charge during quenching. The propeller diameter is 325 mm driven by 5.5/7.5 kW motors through VFD with 2/4 nos. agitators depending upon the size of furnace.



Charge Loading Side



Charge Unloading Side

- High uniformity and reproducibility of heat treatment results.
- Fully automatic operation through PLC, HMI and latest process control systems.
- Computerised Data Logging System.
- Fully Automatic no man operation plants through **iFACE** (intelligent Fully Automatic Controlled Equipment)
- Gross Capacities : 1500 and 1800 kg / batch.

**STANDARD SIZES FOR D.C SQF LINE**

Type	Useful Charge Dimensions W x H x L (mm)	Useful Charge Volume (m <sup>3</sup> )	Gross Charge Max. (kg)	Heating Power (kW)	
				Chamber 1	Chamber 2
5/2	900 x 850 x 1500	1.15	2 x 1500	180	90
5/2	900 x 900 x 1300	1.05	2 x 1500	180	90
5/2	900 x 900 x 1500	1.22	2 x 1800	210	105

Special dimensions are available for your special needs.

# Continuous Pusher Furnace

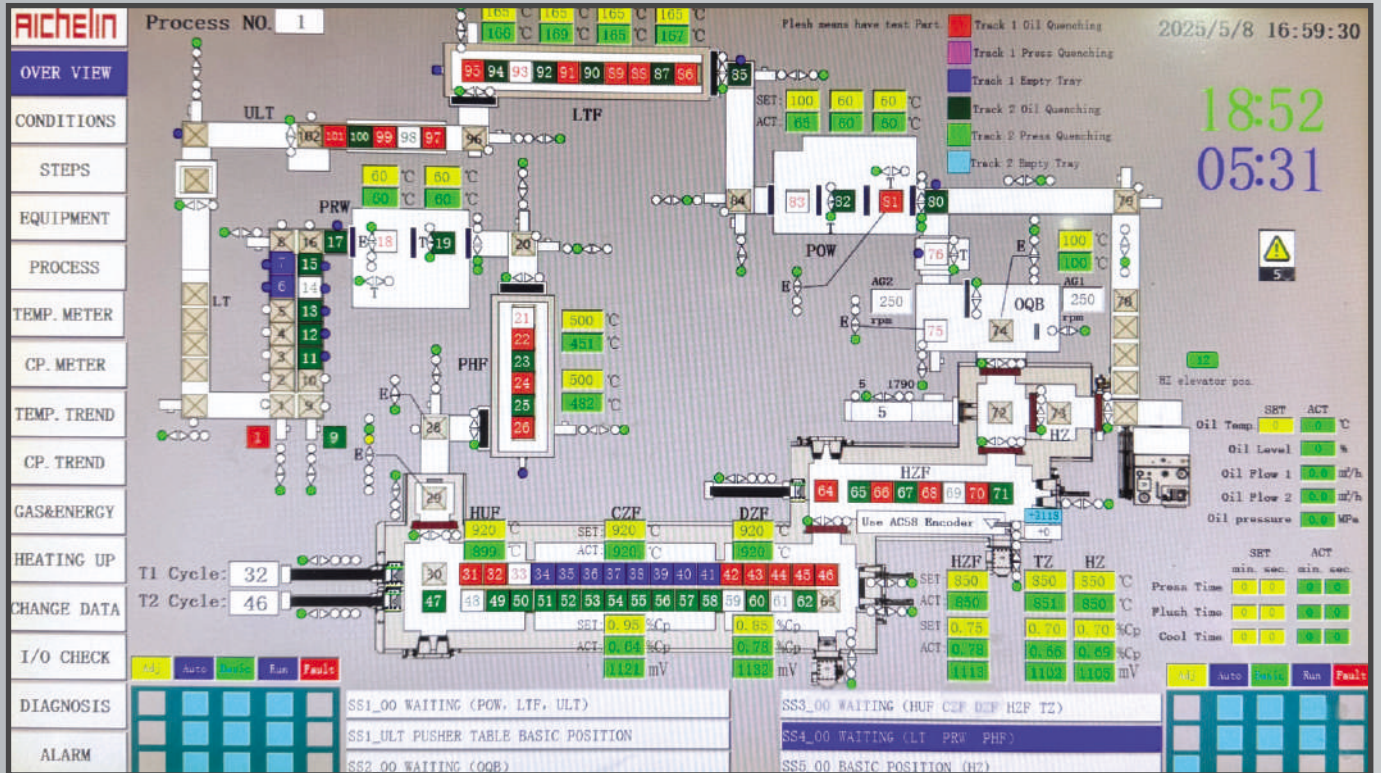

## HEAT TREATMENT PROCESS

For case hardening, through hardening, carbonitriding, normalising and annealing.

## MAIN CHARACTERISTICS

- Electric / Gas heated options available.
- Oil / Salt / Press Quenching.
- High capacities with reproducible quality.
- Low heat treatment costs per kg.
- Flexibility with single / twin track carburising furnace for different cycle times and different CHD parts.
- Low energy and media consumption with Recuperative gas burners.
- Worldwide references (More than 600 installations in Europe, China, India).
- Capacity varying from 400 kg/hr. to 2000 kg/hr.

## SPECIAL FEATURES

- Loading in Carburising furnace via bottom loader. This eliminates requirement of gas curtain and lowers running cost.
- Free Oil Quench Tank with two dedicated elevators for Quenching and Unloading from Quench Tank.
- Two separate free Oil Quench Tanks option available.
- Pre and post wash with FLEXICLEAN® (Vacuum Washing Machine) option available.
- Holding Chamber with Bottom Lifter with Servo Drive for high precision and accuracy for 6 - 8 layer per batch.
- Press Quenching done by FANUC Robots.
- Furnace with high-pressure gas quenching with N2 option available for lower distortion.



Charge Loading / Unloading Area



Press Quenching Charge Unloading Area

# Mesh Belt Furnace T-Series with Muffle



## HEAT TREATMENT PROCESS

For austenitizing and martempering in oil, austenitizing and austempering in salt, case hardening (carburising), carbonitriding and through hardening.

## MAIN CHARACTERISTICS

- Mesh Belt Furnace with muffle.
- Furnaces for continuous heat treatment using mesh belt and integral quench tank.
- Electric / Gas heated options available.
- Complemented with protective-gas generators and advance process control system.
- For treating parts in bulk or positioned on the belt, normally weighing up to approx. 0.45 kg, depending on their geometry and the desired result up to 0.5 mm CHD.
- Suitable for medium / high volume production.
- The range of available furnaces covers output from 30 to 500 kg/hr. depending on the type of part and the required heat treatment.
- Special ECO Box at entrance for lower oxygen.

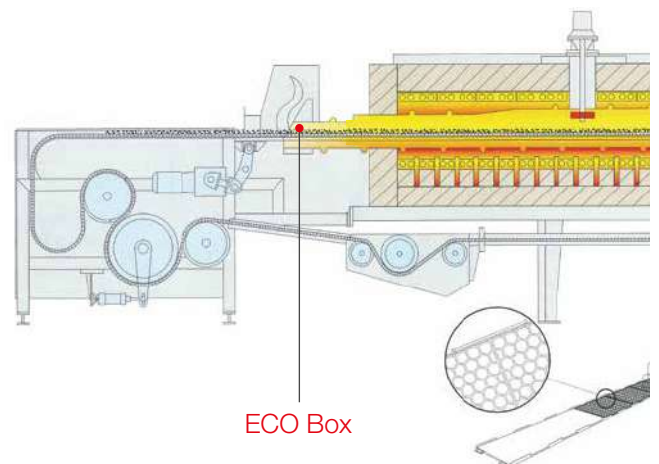

## SUITABLE FOR PARTS

Bearing components, mass-production of parts for automobile industry, connector and sleeves for electrical terminal connectors, screws and bolts, fasteners, blanks and chain components etc.

# Mesh Belt Furnace TC-Series without Muffle



## HEAT TREATMENT PROCESS

For austenitizing and martempering in oil, austenitizing and austempering in salt, case hardening (carburising), carbonitriding and through hardening.

## MAIN CHARACTERISTICS

- Mesh Belt Furnace without muffle.
- Furnaces for continuous heat treatment using conveyor and integral quench tank.
- Electric / Gas heated options available.
- Complemented with protective-gas generators and advance process control system.
- For treating parts in bulk or positioned on the belt, normally weighing up to approx. 0.45 kg, depending on their geometry and the desired result up to 0.5 mm CHD.
- Suitable for medium / high volume production.
- The range of available furnaces covers output from 500 to 2000 kg/hr. depending on the type of part and the required treatment.

## SUITABLE FOR PARTS

Bearing components, mass-production of parts for the automobile industry, connector and sleeves for electrical terminal connectors, screws and bolts, fasteners, blanks and chain components etc.

# Roller Hearth Furnace



## HEAT TREATMENT PROCESS

For hardening with oil / salt / polymer, hardening / forming with press quench, isothermal annealing with controlled cooling via recipe program, annealing, normalising and stress relieving.

## MAIN CHARACTERISTICS

- Electric / Gas heated options available.
- Furnace atmosphere-Endo Gas / Methanol + N<sub>2</sub> / N<sub>2</sub>
- Roller diameter: 15 - 230 mm.
- Loading of parts directly on rollers with quenching through chute.
- Loading of parts in the baskets / fixtures with quenching through elevator.
- Recipe based ISO cooling with bidirectional air flow for uniform cooling of parts with part temperature monitoring.
- Sturdy and rugged design with electro-mechanical drive system results in lower break down for higher uptime.
- Furnace Capacity: 100 to 2000 kg/hr.

## SUITABLE FOR PARTS

Bearings, bearings for wind energy, automotive parts, gear parts, cold forge parts like billets and shafts, semi-finished parts etc.

# Rotary Hearth Furnace

## HEAT TREATMENT PROCESS

For hardening by reheating with press quenching / plug quenching.

## MAIN CHARACTERISTICS

- Electric / Gas heated options available.
- Indexed or continuous rotation.
- Hearth supported on special geared bearing coupled with electro-mechanical drive controlled by VFD.
- Hearth drive with infinitely adjustable speed.
- Loading / unloading through single or double door design as per customer requirements.
- Loading of parts in single / multi - layer inside the furnace hearth.
- Manipulator for automatic loading / unloading of parts from the furnace.
- Capacities: 70 to 700 kg/hr.

## STANDARD SIZES FOR ROTARY HEARTH FURNACE

Type	Hearth Diameter (mm)	Capacity (kg/hr.)
RD 130	1300	70
RD 170	1700	200
RD 230	2300	300
RD 270	2700	500
RD 350	3500	700

## SUITABLE FOR PARTS

Crown wheels, gear components, bearing and clutch components.



# Gas Nitriding Furnace with Retort

## HEAT TREATMENT PROCESS

For gas nitriding, gas nitro-carburising, bright annealing and thermal oxidation.

## MAIN CHARACTERISTICS

- Horizontal loading sealed retort furnace design.
- Sealed Retort made of SS310 / Inconel 800 options available.
- Electrically heated with heaters and radiant tube located outside retort.
- Special door design with bayonet locking system for precision sealing.
- Special shape door seal without joint for effective sealing and safety.
- NH<sub>3</sub> + N<sub>2</sub> + CO<sub>2</sub> / ENDO + H<sub>2</sub> atmosphere for Gas Nitriding and Gas Nitro-carburising.
- Water / Steam atmosphere for post oxidation / thermal oxidation.
- Latest Nitriding potential process control system with H<sub>2</sub> / O<sub>2</sub> sensors and mass flow meters.
- Option of automatic Kn control available through recipe program.
- Temperature uniformity +/- 5°C with thyristor control.
- Forced rapid cooling for shorter cycle times.
- Computerized process monitoring and data logging.
- Capacity varying from 350 to 1500 kg / batch.

## SUITABLE FOR PARTS

Ring gears, automotive parts and machining tools etc.



# Pit Type Furnace



## HEAT TREATMENT PROCESS

For gas carburising, case hardening, carbo-nitriding, bright annealing, nitriding, nitrocarburising, H<sub>2</sub> dewaxing and sintering.

## MAIN CHARACTERISTICS

- Retort type furnace design with close bottom for direct loading on retort.
- Retort type furnace design with compensator / oil cup for loading heavy parts on hearth.
- Options for retortless furnace also available.
- Gas guide cylinder for uniform temperature and gas atmosphere distribution.
- High capacity re-circulation fan for high temperature / Cp uniformity.
- Quench media: Oil / Salt / Polymer.
- Electrically heated with special fibrothol heating systems.
- EndoGas / Methanol, N<sub>2</sub> Ammonia, Carbon Dioxide and Hydrogen atmosphere options available.

- Nitriding potential process control system with O<sub>2</sub> / H<sub>2</sub> sensors and mass flow meters.
- Forced rapid cooling for shorter cycle times.
- Sizes upto 3m Dia x 4m Height.
- Capacity varying from 1000 to 20,000 kg / batch.

## SUITABLE FOR PARTS

- Large gears, shafts, bearing components, automotive parts etc.

# Chamber Washing Machine (KEKTE Design)

For high-quality washing processes in water based alkaline solutions before and after heat treatment.

## MAIN CHARACTERISTICS

- With immersion, dunking, spraying and drying.
- Spraying system with rotating jet arms.
- Option of one / two washing liquid containers with mild steel / stainless steel construction.
- Drying device by hot air (optional)
- Coalescence oil separation by disk-phase separator working on the principle of gravity and coalescence.
- Fresh water automatic top-up to spray and rinse tank.



## OPTIONS AVAILABLE

- KEKTE/UHWT (ISDe) electrically heated
- KEKTE/UHWT (ISDe) gas heated

# FLEXICLEAN<sup>®</sup> Vacuum Washing Machine



These patented units are used especially where highest levels of cleaning quality are required and / or geometrically complex components are to be cleaned.

The essential components include a vacuum-tight cleaning chamber, isolated tanks for two (optionally: three) cleaning agents, vacuum pump, spray pump and heating for each cleaning media and an oil separation units.

## **LOW PRESSURE BOILING VACUPEARL<sup>®</sup>**

The patented Vacupearl system works by creating a vacuum above the bath level. This causes the cleaning fluid to start to boil and steam bubbles form predominately on the workpiece surface of the charge. Low pressure boiling helps in improved cleaning effect in inaccessible areas. This has two separate tanks with dual cleaning media (optionally: three) in individual tanks and drying.

## **OPTIONS AVAILABLE**

- EKFE - electrically heated
- EKFG - gas heated

## **THIS PROVIDES THE FOLLOWING ADVANTAGES**

- Low-pressure boiling VACUPEARL<sup>®</sup> for improved cleaning effect, even in inaccessible areas.
- Vacuum drying unit for achieving completely dry components.
- Stainless steel design.
- Oil separation for each cleaning agent (optional).
- Heater exchange without emptying the tank.
- Operation produces almost no wastewater and exhaust air.
- Short cycles and low energy consumption.

# Heat Treatment Furnace for Aluminium Industry



Ultimate in Flexibility and Versatility for the Aluminium Industry

## HEAT TREATMENT PROCESS

For T6 with water quenching, T7 with air quenching, T5 with artificial aging, homogenizing, annealing and stress relieving, removal of sand from castings.

## FURNACE TYPES

- Continuous roller hearth furnace.
- Chain conveyor furnace.
- Basketless direct part loading furnace.

## QUENCH SYSTEM

- Options available for water, polymer or air quench.
- Optimum heating, cooling and re-circulating system.
- Rapid transfer time from the furnace to fully submerged in the quenchant.
- Specially designed elevator without bearings for trouble free operations and least maintenance.

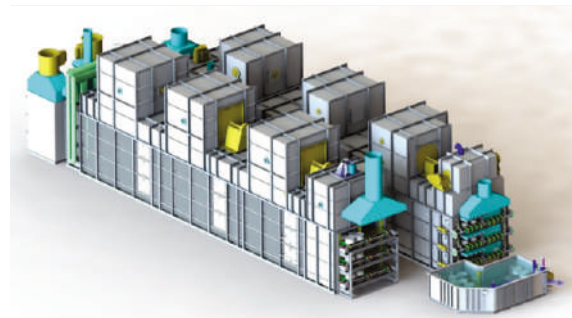

Chain Conveyor T6 Line "BASKETLESS"

## APPLICATIONS

AFC-Holcroft has experience providing heat-treat processes for the following products:

- Aluminium wheels for automobiles, trucks, motorcycles and aircraft.
- Automotive engine blocks, heads, pistons, water pumps, intake manifolds and transmission casings.
- Automotive and aircraft suspension components.
- Aluminium cylinders i.e. automobile air bags, SCUBA tanks and fire extinguishers.
- Aluminium castings, forgings, fabrication and stampings.

# Vertical Bottom Drop Furnace for Aluminium Industry

AICHELIN UNITHERM offers a state-of-the-art Vertical Bottom Drop Furnace for solution annealing of aluminium components, designed with advanced features for high performance, safety, and repeatability of heat treatment results.

## MAIN CHARACTERISTICS

- **Bottom Cover Opening:** Bottom door gets opened by hydraulic cylinder guided through special slot. This is a unique design arrangement which makes cover to go downwards and swing aside in one stroke to attain minimum opening time.
- **Vertical Drop Mechanism:** Electro-hydraulic system for smooth and quick charge lowering for quenching. Unique double-fall mechanism allows fast quenching of charge within 10 seconds after door opening.
- Nickel-Chromium hairpin elements mounted on heat-resistant supports ensure even heat distribution.
- **Roof-mounted high-capacity re-circulating fan with guide baffles** ensures excellent temperature uniformity throughout the charge space.
- **Integrated Quenching System:** Motorized trolley with loading table and water quench tank with features like water agitation, electric heating and plate heat exchanger for efficient cooling.
- **Advance Automation and PLC Control System:** PLC system with HMI for automatic operation, timer settings and real-time alarm display.
- **Safety and Standards:** Includes thermocouple failure detection, interlocks for fan-heater safety. Compliant with ASM 2750, NADCAP and CQI9 standards.

## APPLICATIONS

Ideal for aluminium heat treatment applications requiring high uniformity, fast quenching and strict process control such as aerospace, automotive and precision engineering sectors etc.



# Bogie Hearth Furnace



## HEAT TREATMENT PROCESS

For reheating, annealing, normalising, tempering, stress relieving.

For the Steel Industry AICHELIN UNITHERM will provide state-of-the art high temperature and large capacity Bogie Hearth and Box Type heat treatment furnaces which will be manufactured in India based on the know-how and design from BOSIO (part of the AICHELIN Group).

AICHELIN UNITHERM also have co-operation with a local partner in India to offer economical Bogie Hearth and Box Type heat treatment furnaces based on proven design and technical know-how.

## MAIN CHARACTERISTICS

- Customised design as per specific needs.
- Gas and Electric heating depending upon temperature in the furnace.
- High quality grade insulation.
- Excellent temperature uniformity.
- BOSIO developed pneumatic sealing system for door and bogie. It ensures better sealing by preventing hot air leakage from furnace and entry of cold surroundings air into the furnace.
- Better sealing ensures lower fuel consumption (higher overall efficiency of the furnace).
- OXYGEN: BOSIO developed system for oxygen regulation in Gas heated furnaces.
- Furnace pressure control during heating up and soaking is achievable by special damper flap with electro-motor drive arrangement.

## SUITABLE FOR INDUSTRIES

- Steel industry, reheating and foundries.

# Endo Gas Generator



## PROTECTIVE GAS GENERATOR

Gas carburising processes and other heat treatments under protective gas, where the carbon exchange with the work piece surface plays an important role, make high demands on the controllability of the atmosphere. The carrier gas procedure using endogas, proven since many years, offers the best atmosphere conditions and accordingly process engineering for the following:

- Exact process control.
- Best reproducibility of the final results.
- High quality requirements.
- Capacity varying from Endo 20, 30, 40, 60, 80, 100, 120 m<sup>3</sup>/hr.

## THE $\lambda$ -PROBE CONTROL

The measuring gas is conducted through a temperature-constant -probe. At the same time a mV-signal is emitted by the  $\lambda$ -probe, which is used for measuring, control and regeneration of the Endogas-composition and is displayed in °C dew point.

A very precise control of gas/air mixture is required to produce constant quality of endogas.

## QUANTITY CONTROL

The Endogas generator capacity can be adjusted to the required capacity manually or by automatic quantity control. The unused protective gas is burned off in manually controlled Endo Gas Generator. In automatic controlled quality control system the amount of Endogas is generated automatically with minimum wastage at burn-off.

Through adapted design and using the imported compressor the Endogas generation can be controlled in the range of 100 %, 75% and 50 % of the nominal capacity is now possible.

# Manufacturing Set Up Pune Factory



AICHELIN UNITHERM Upcoming New Factory at Talegaon-Pune, India



AICHELIN UNITHERM Manufacturing Plant at Talegaon-Pune, India

# Our Customers Our Pride



Bright Precision Machining Works Pvt. Ltd.



AICHELIN Holding  
Headquarters Aichelin  
Group AICHELIN (Austria)



AICHELIN ST  
Vacuum GmbH  
(Austria)



AICHELIN Service,  
NOXMAT (Germany)



SAFED Suisse,  
(France)



BOSIO  
(Slovenia)



AFC-Holcroft  
(USA)



AICHELIN Heat  
Treatment Systems  
(China)  
NOXMAT (China)



AICHELIN UNITHERM  
Heat Treatment Systems  
(India)  
NOXMAT (India)

# UNITHERM

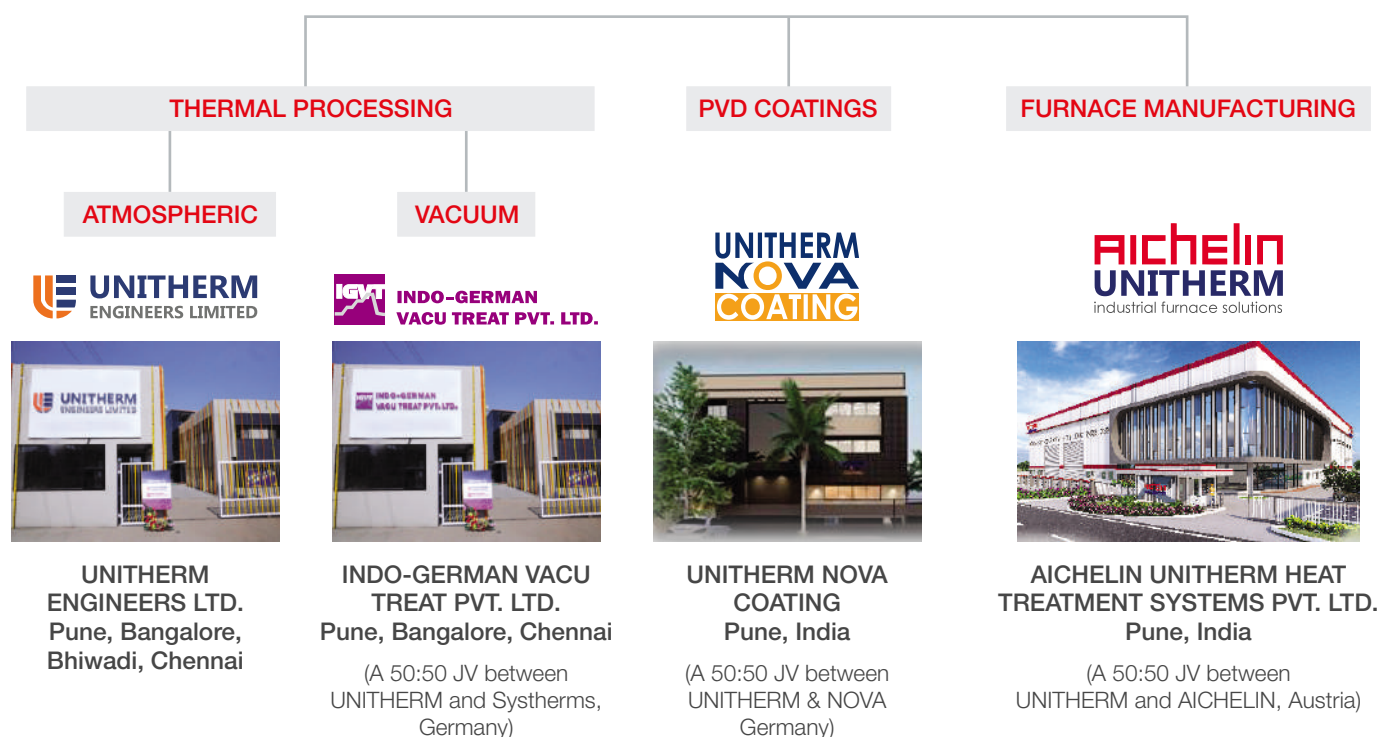

Aichelin

**Factory Address:**

AICHELIN UNITHERM HEAT TREATMENT  
SYSTEMS INDIA PVT. LTD.

Gat No. 38, B.M. Kakade Industrial Park,  
Jadhavwadi Road, Village Navalakh Umbre,  
Next to Talegaon MIDC, Tal. Maval,  
Dist. Pune - 410507, Maharashtra, India.

✉ sales@au-india.com

**Corporate Office Address:**

AICHELIN UNITHERM HEAT TREATMENT  
SYSTEMS INDIA PVT. LTD.

Office No. 103/1, Om Chambers,  
Plot No. 29/ 31, T-Block, Bhosari Telco Road  
Balaji Nagar, Bhosari MIDC, Pune - 411026,  
Maharashtra, India.

☎ +91 89569 02169

[www.au-india.com](http://www.au-india.com)