

Henco is

the perfect fit.



Product Overview



Product Overview

Henco is the perfect fit.

At Henco everything is about the perfect connection. Our aim is ensuring that all installers can connect our multilayer pipes correctly, quickly, and easily, which leads to a more efficient installation process. Our goal is to empower installers and merchants with knowledge about the Henco product range. Every day, for every project, Henco is the perfect fit.

Within this catalogue you will be introduced to the patented Henco multilayer pipe range, our press fittings that have features to help improve installations and our full underfloor heating options. With over 30 years in manufacturing, you can be confident that our products offer reliability and durability. Every installer is backed by MyHenco, your digital assistant that is the perfect platform to view technical data sheets, best practice webinars and much more.

Product standards

Henco manufactures and delivers a complete and coordinated range of products that stands out for their reliability and continual technological advancements. With numerous international certifications including WRAS and KIWA, you can be confident that Henco products are the perfect fit.

Multilayer pipe – The heart of our range

Our patented multilayer pipe is the backbone of the Henco range. At Henco we truly believe “only the best is good enough” and this is why our pipe meets the highest standards to give the installer the confidence that they are using the right product.

Wide range of products

Adding to our multilayer pipe range Henco offers a wide range of high-quality fittings. Giving installers the choice of press and push fittings, each offering many variations from compression fittings, valves, and a wide range of manifolds. Henco understands that every installation needs the correct tools and that is why we offer a wide range of hand tools and press machines to make sure the installation is done not only the efficient way, but the correct way.

Henco Underfloor Heating

Henco offers a full comprehensive range of products suitable for underfloor heating installations.

Research and development

Henco has a dedicated team that focusses on improving our current product ranges and looking at new advanced solutions to meet the demands and needs of an ever-changing market. We not only look at what the industry requires, we also give the installers a voice and listen to their day to day requirements. Our focus on research and technical progress means our aim is to always offer our customer the best products backed up with the latest technology.

Aalberts NV – Empowered by a larger group

Henco is proud to be part of Aalberts NV who are a global technology company, focused on creating innovative solutions for various industries. Being a part of the Aalberts family means we can use their expertise in technology and manufacturing to help deliver the highest quality Henco products.

MyHenco – Your Ultimate Digital assistant

With MyHenco, we offer installers an easy-to-use platform where you can access technical data sheets, webinars with tips & tricks, handy calculation tools, and much more.



Register for free
at **MyHenco.com**



1. Pipes	6	C. Brass Manifolds	117
A. Standard (PE-Xc/AL/PE-Xc)	7	D. Manifold Accessories	121
B. Standard ISO (PE-Xc/AL/PE-Xc)	8		
C. RIXc (PE-Xc/AL/PE-Xc)	14	8. Valves	123
D. RIXc ISO (PE-Xc/AL/PE-Xc)	15		
E. Floor-RIXc (PE-Xc/AL/PE-Xc)	19	9. Henco Smart Monitoring	127
F. PE-Xc	20		
G. PE-RT	21	10. Underfloor Heating	129
H. Protection Hose	22	A. Systems	130
I. Gas Standard (PE-Xc/AL/PE-Xc)	23	B. Manifolds	137
J. Sprinkler Standard (PE-Xc/AL/PE-Xc)	24	B. Wired	147
		D. Wireless	149
		E. Electric Underfloor Heating	153
2. Henco Press	25	11. UFH Cabinets	155
A. PK	26		
B. PKG	38	12. Tools	157
C. Super Sizes	47		
D. Henco Ecoline	52	13. Accessories	177
3. Vision	67	14. Sprinkler	181
		Certificates	192
4. Henco Pro-Fit	75		
		Index	194
5. Brass Press	77		
6. Brass Compression	100		
7. Manifolds	108		
A. Pro-Flow Manifold	109		
B. Full Flow Manifold	112		

Henco Sustainability

Sustainability, also our concern

Henco products are suitable for hot-cold water installations, central heating installations and underfloor heating installations.

Switching to Henco's multilayer pipe and fittings can immediately make improvements to an organisation's sustainability requirements compared to other alternative materials. The manufacturing process of multilayer pipe has a lower environmental impact and the overall energy consumed is lower compared to alternative materials.

For Henco, this is not enough. We firmly believe in the 3 P's: People, Planet, Profitability.

Corporate sustainability for us means a key focus on these three pillars, setting firm policies and strategies for our internal & external employees and reinvesting the company's profits back into Henco and helping to reach the goal of becoming net zero carbon by 2050. At Henco we manage, measure & monitor both our energy consumptions and our CO2 emissions. It is our objective to decrease our CO2 intensity for scope 1 and 2 by 70% by 2030, taking 2019 as a base line year.



The logo for Kiwa, featuring the word "kiwa" in blue lowercase letters and a red stylized bird-like shape to the right.

ISO14001 certified

All the effort we put into environmental matters resulted in Henco getting through the certification audits for ISO14001. After 3 days of audits on various business processes, we achieved a very positive audit result without any recorded remarks. The auditor praised, among other things, the enthusiasm of our employees and the broad demonstration of sustainability throughout our processes.

The logo for Aalberts, featuring a large red stylized letter 'A' above the word "aalberts" in red lowercase letters, with the tagline "mission critical technologies" in smaller red text below.

Aalberts Sustainability Award 2021

Aalberts also saw that we at Henco value sustainability and that we show this through all our actions. In 2022 we were very pleased to accept the Aalberts sustainability awards 2021.

The logo for VOKA, featuring the letters "VOKA" in a stylized font where the 'V' and 'O' are red and the 'K' and 'A' are black, followed by the text "Vlaams netwerk van ondernemingen" in black.

The VOKA sustainability charter: SDG pioneers

The VOKA sustainability charter was achieved by Henco for the 3rd year in a row. With this, we have officially been appointed as SDG pioneers. Sustainability is held in high esteem at Henco, this certificate proves it and we are proud of it.

The logo for Cochebat, featuring a stylized blue and red circular graphic to the left of the word "cochebat" in blue lowercase letters, with the tagline "le confort hydraulique du bâtiment" in smaller blue text below.

Environmental and health statement Cochebat

The French HVAC association Cochebat has tested and approved our Henco multi-layer pipes and we were rewarded with inclusion in their Environmental and Health Statement.

The logo for Interseroh, featuring a stylized blue and grey circular graphic above the word "interseroh" in blue lowercase letters.

Interseroh Certificate Resources Saved

In 2020 and 2021 Henco received the Interseroh Certificate for Resources Saved in Germany. By recycling materials in 2021, a calculated 42,269 kilograms of resources and, in addition to this, 5,521 kilograms of greenhouse gases were saved.

The logo for Eco Platform EPD Verified, featuring the text "ECO PLATFORM" in small black letters above "EPD" in large green letters, with "VERIFIED" in smaller green letters below.

EPD

As a construction partner, we share responsibility for the world of tomorrow. At Henco, we believe that sustainability begins with transparency. That's why the environmental performance of our products is now available in official Environmental Product Declarations (EPDs).



Henco Pipes

	<i>Page</i>
<i>Standard (PE-Xc/AL/PE-Xc)</i>	<i>7</i>
<i>Standard ISO (PE-Xc/AL/PE-Xc)</i>	<i>8</i>
<i>RIXc (PE-Xc/AL/PE-Xc)</i>	<i>14</i>
<i>RIXc ISO (PE-Xc/AL/PE-Xc)</i>	<i>15</i>
<i>FLOOR-RIXc (PE-Xc/AL/PE-Xc)</i>	<i>19</i>
<i>PE-Xc</i>	<i>20</i>
<i>PE-RT</i>	<i>21</i>
<i>Protection Hose</i>	<i>22</i>
<i>Gas Standard (PE-Xc/AL/PE-Xc)</i>	<i>23</i>
<i>Sprinkler Standard (PE-Xc/AL/PE-Xc)</i>	<i>24</i>



Maximum working pressure (bar) for the different pipe types and diameters

Diameter (mm)	12	14	16	16	18	18	20	20	26	26	32	40	50	63	75	90
Pipe type	STA	STA	STA	RIXC	STA	RIXC	STA	RIXC	STA	RIXC	STA	STA	STA	STA	STA	STA
Max working pressure (bar)	6	10	16	10	10	10	16	10	16	10	16	10	10	10	10	10

Type: COIL STANDARD



Henco multilayer pipe Standard (Coil)
Henco meerlagenbuis Standaard (Rol)
Henco tube multicouche Standard (Rouleau)
Henco Mehrschichtverbundrohr Standard (Rohr)

Article number	Coil / Pallet	Type	Pallet dimension (mm)
100-121688*	100 m / 2200 m	12x1,6	800x800
200-121688*	200 m / 3000 m	12x1,6	800x800
100-140210	100 m / 2200 m	14x2	800x800
200-140210	200 m / 3000 m	14x2	800x800
50-160212	50 m / 1500 m	16x2	1200x800
100-160212	100 m / 2200 m	16x2	800x800
200-160212	200 m / 2600 m	16x2	800x800
500-160212	500 m / 2500 m	16x2	800x800
100-180214	100 m / 1700 m	18x2	800x800
200-180214	200 m / 2000 m	18x2	800x800
25-200216	25 m / 800 m	20x2	1200x800
50-200216	50 m / 1000 m	20x2	1200x800
100-200216	100 m / 1500 m	20x2	800x800
25-260320	25 m / 500 m	26x3	750x750
50-260320	50 m / 800 m	26x3	800x800
25-320326	25 m / 500 m	32x3	900x900
50-320326	50 m / 650 m	32x3	900x900

*Application class 4 (EN ISO 21003-1): maximum operating temperature 60 °C and maximum operating pressure 6 bar

Type: COIL CSC



Henco multilayer pipe Standard (Coil with small core)
Henco meerlagenbuis Standaard (Rol kleine kern)
Henco tube multicouche Standard (Petit rouleau noyau intérieure)
Henco Mehrschichtverbundrohr Standard (Rohr kleinen Kern)

Article number	Coil / Pallet	Type	Pallet dimension (mm)
10-160212-KB	10 m / 800 m	16x2	1200x800
25-160212-KB	25 m / 1125 m	16x2	1200x800
25-200216-KB	25 m / 900 m	20x2	1200x800

internal coil diameter = 28 cm



Henco Pipes

Standard ISO (PE-Xc/AL/PE-Xc)

1 Type: STRAIGHT LENGTH



Henco multilayer pipe Standard (Straight length)
Henco meerlagenbuis (Stang)
Henco tube multicouche Standard (Barre)
Henco Mehrschichtverbundrohr (Stange)

Article number	Cylinder / Pallet	Type	Pallet dimension (mm)
03-160212	75 m / 3600 m	16x2	4000x705
04-160212	100 m / 4800 m	16x2	4100x705
05-160212	125 m / 6000 m	16x2	5100x705
03-180214	60 m / 2880 m	18x2	4000x705
05-180214*	100 m / 4800 m	18x2	5100x705
03-200216	54 m / 2592 m	20x2	4000x705
04-200216	72 m / 3456 m	20x2	4100x705
05-200216	90 m / 4320 m	20x2	5100x705
03-260320	30 m / 1440 m	26x3	4000x705
04-260320	40 m / 1920 m	26x3	4100x705
05-260320	50 m / 2400 m	26x3	5100x705
03-320326	21 m / 1008 m	32x3	4000x705
04-320326	28 m / 1344 m	32x3	4100x705
05-320326	35 m / 1680 m	32x3	5100x705
03-403533	27 m / 648 m	40x3,5	4000x705
04-403533	36 m / 864 m	40x3,5	4100x705
05-403533	45 m / 1080 m	40x3,5	5100x705
03-504042	21 m / 504 m	50x4	4000x705
04-504042	28 m / 672 m	50x4	4100x705
05-504042	35 m / 840 m	50x4	5100x705
03-634554	12 m / 288 m	63x4,5	4000x705
04-634554	16 m / 384 m	63x4,5	4100x705
05-634554	20 m / 480 m	63x4,5	5100x705
05-756063	10 m / 240 m	75x6	5100x705
05-907076	5 m / 240 m	90x7	5100x705

**TILL EXHAUSTION OF STOCK*

Type: ISO4 (6 mm) Fireclass: CL, s1-d0



Henco tube pre-insulated Standard (6mm)
Henco voorgeïsoleerde buis Standaard (6mm)
Henco tube pré-isolé Standard (6mm)
Henco Rohr Isoliert Standard (6mm)

Article number	Coil / Pallet	Type	Pallet dimension (mm)
100-ISO4-14-BL	100 m / 1000 m	14x2 blue	800x800
100-ISO4-14-RO	100 m / 1000 m	14x2 red	800x800
25-ISO4-16-BL	25 m / 450 m	16x2 blue	800x800
25-ISO4-16-RO	25 m / 450 m	16x2 red	800x800
50-ISO4-16-BL	50 m / 800 m	16x2 blue	800x800
50-ISO4-16-RO	50 m / 800 m	16x2 red	800x800
100-ISO4-16-BL	100 m / 900 m	16x2 blue	800x800
100-ISO4-16-RO	100 m / 900 m	16x2 red	800x800



Type: ISO4 (6 mm) Fireclass: CL, s1-d0



Article number	Coil / Pallet	Type	Pallet dimension (mm)
50-ISO4-18-BL	50 m / 650 m	18x2 blue	800x800
50-ISO4-18-RO	50 m / 650 m	18x2 red	800x800
25-ISO4-20-BL	25 m / 450 m	20x2 blue	800x800
25-ISO4-20-RO	25 m / 450 m	20x2 red	800x800
50-ISO4-20-BL	50 m / 700 m	20x2 blue	800x800
50-ISO4-20-RO	50 m / 700 m	20x2 red	800x800
100-ISO4-20-BL	100 m / 900 m	20x2 blue	800x800
100-ISO4-20-RO	100 m / 900 m	20x2 red	800x800
25-ISO4-26-BL	25 m / 300 m	26x3 blue	800x800
25-ISO4-26-RO	25 m / 300 m	26x3 red	800x800
50-ISO4-26-BL	50 m / 500 m	26x3 blue	800x800
50-ISO4-26-RO	50 m / 500 m	26x3 red	800x800
25-ISO4-32-BL	25 m / 300 m	32x3 blue	800x800
25-ISO4-32-RO	25 m / 300 m	32x3 red	800x800
50-ISO4-32-BL	50 m / 300 m	32x3 blue	800x800
50-ISO4-32-RO	50 m / 300 m	32x3 red	800x800

Type: ISO4 BSD (6 mm) Fireclass: BL, s1-d0



Henco tube pre-insulated Standard (6mm) - Improved fire class
Henco voorgeïsoleerde buis Standaard (6mm) - verbeterde brandklasse
Henco tube pré-isolé Standard (6mm) - meilleur classement au feu
Henco Rohr Isoliert Standard (6mm) - Verbesserte Brandklasse

Article number	Coil / Pallet	Type	Pallet dimension (mm)
100-ISO4-14-BL-BSD	100 m / 1000 m	14x2 blue	800x800
100-ISO4-14-RO-BSD	100 m / 1000 m	14x2 red	800x800
50-ISO4-16-BL-BSD	50 m / 800 m	16x2 blue	800x800
50-ISO4-16-RO-BSD	50 m / 800 m	16x2 red	800x800
100-ISO4-16-BL-BSD	100 m / 900 m	16x2 blue	800x800
100-ISO4-16-RO-BSD	100 m / 900 m	16x2 red	800x800
50-ISO4-18-BL-BSD	50 m / 650 m	18x2 blue	800x800
50-ISO4-18-RO-BSD	50 m / 650 m	18x2 red	800x800
50-ISO4-20-BL-BSD	50 m / 700 m	20x2 blue	800x800
50-ISO4-20-RO-BSD	50 m / 700 m	20x2 red	800x800
100-ISO4-20-BL-BSD	100 m / 900 m	20x2 blue	800x800
100-ISO4-20-RO-BSD	100 m / 1100 m	20x2 red	800x800
25-ISO4-26-BL-BSD	25 m / 400 m	26x3 blue	800x800
25-ISO4-26-RO-BSD	25 m / 400 m	26x3 red	800x800
50-ISO4-26-BL-BSD	50 m / 500 m	26x3 blue	800x800
50-ISO4-26-RO-BSD	50 m / 500 m	26x3 red	800x800
25-ISO4-32-BL-BSD	25 m / 300 m	32x3 blue	800x800
25-ISO4-32-RO-BSD	25 m / 300 m	32x3 red	800x800
50-ISO4-32-BL-BSD	50 m / 300 m	32x3 blue	800x800
50-ISO4-32-RO-BSD	50 m / 300 m	32x3 red	800x800



Henco Pipes

Standard ISO (PE-Xc/AL/PE-Xc)

- 1
- 2
- 3
- 4
- 5
- 6
- 7
- 8
- 9
- 10
- 11
- 12
- 13
- 14

Type: ISO9 (10 mm) Fireclass: CL, s1-d0



Henco tube pre-insulated Standard (10mm)
Henco voorgeïsoleerde buis Standaard (10mm)
Henco tube pré-isolé Standard (10mm)
Henco Rohr Isoliert Standard (10mm)

Article number	Coil / Pallet	Type	Pallet dimension (mm)
50-ISO9-14-BL	50 m / 550 m	14x2 blue	800x800
50-ISO9-14-RO	50 m / 550 m	14x2 red	800x800
50-ISO9-16-BL	50 m / 600 m	16x2 blue	800x800
50-ISO9-16-RO	50 m / 600 m	16x2 red	800x800
50-ISO9-18-BL	50 m / 500 m	18x2 blue	800x800
50-ISO9-18-RO	50 m / 500 m	18x2 red	800x800
50-ISO9-20-BL	50 m / 400 m	20x2 blue	800x800
50-ISO9-20-RO	50 m / 400 m	20x2 red	800x800
25-ISO9-26-BL	25 m / 325 m	26x3 blue	800x800
25-ISO9-26-RO	25 m / 325 m	26x3 red	800x800
50-ISO9-26-BL	50 m / 400 m	26x3 blue	800x800
50-ISO9-26-RO	50 m / 400 m	26x3 red	800x800
25-ISO9-32-BL	25 m / 250 m	32x3 blue	800x800
25-ISO9-32-RO	25 m / 250 m	32x3 red	800x800
50-ISO9-32-BL	50 m / 250 m	32x3 blue	800x800
50-ISO9-32-RO	50 m / 250 m	32x3 red	800x800

Type: ISO9 BSD (10 mm) Fireclass: BL, s1-d0



Henco tube pre-insulated Standard (10mm) - Improved fire class
Henco voorgeïsoleerde buis Standaard (10mm) - verbeterde brandklasse
Henco tube pré-isolé Standard (10mm) - meilleur classement au feu
Henco Rohr Isoliert Standard (10mm) - Verbesserte Brandklasse

Article number	Coil / Pallet	Type	Pallet dimension (mm)
50-ISO9-14-BL-BSD	50 m / 550 m	14x2 blue	800x800
50-ISO9-14-RO-BSD	50 m / 550 m	14x2 red	800x800
50-ISO9-16-BL-BSD	50 m / 600 m	16x2 blue	800x800
50-ISO9-16-RO-BSD	50 m / 600 m	16x2 red	800x800
50-ISO9-18-BL-BSD	50 m / 500 m	18x2 blue	800x800
50-ISO9-18-RO-BSD	50 m / 500 m	18x2 red	800x800
50-ISO9-20-BL-BSD	50 m / 400 m	20x2 blue	800x800
50-ISO9-20-RO-BSD	50 m / 400 m	20x2 red	800x800
25-ISO9-26-BL-BSD	25 m / 325 m	26x3 blue	800x800
25-ISO9-26-RO-BSD	25 m / 275 m	26x3 red	800x800
50-ISO9-26-BL-BSD	50 m / 450 m	26x3 blue	800x800
50-ISO9-26-RO-BSD	50 m / 450 m	26x3 red	800x800
25-ISO9-32-BL-BSD	25 m / 250 m	32x3 blue	800x800
25-ISO9-32-RO-BSD	25 m / 250 m	32x3 red	800x800
50-ISO9-32-BL-BSD	50 m / 250 m	32x3 blue	800x800
50-ISO9-32-RO-BSD	50 m / 250 m	32x3 red	800x800



Type: ISO13 (13 mm) **Fireclass: CL, s1-d0**



Henco tube pre-insulated Standard (13mm)
Henco voorgeïsoleerde buis Standaard (13mm)
Henco tube pré-isolé Standard (13mm)
Henco Rohr Isoliert Standard (13mm)

Article number	Coil / Pallet	Type	Pallet dimension (mm)
50-ISO13-16-BL	50 m / 400 m	16x2 blue	800x800
50-ISO13-16-RO	50 m / 400 m	16x2 red	800x800
50-ISO13-18-BL*	50 m / 450 m	18x2 blue	800x800
50-ISO13-20-BL	50 m / 400 m	20x2 blue	800x800
50-ISO13-20-RO	50 m / 400 m	20x2 red	800x800
50-ISO13-26-BL	50 m / 300 m	26x3 blue	800x800
50-ISO13-26-RO	50 m / 300 m	26x3 red	800x800
25-ISO13-32-BL	25 m / 200 m	32x3 blue	800x800
25-ISO13-32-RO	25 m / 200 m	32x3 red	800x800

Type: ISO13 BSD (13 mm) **Fireclass: BL, s1-d0**

**TILL EXHAUSTION OF STOCK*



Henco tube pre-insulated Standard (13mm) - Improved fire class
Henco voorgeïsoleerde buis Standaard (13mm) - verbeterde brandklasse
Henco tube pré-isolé Standard (13mm) - meilleur classement au feu
Henco Rohr Isoliert Standard (13mm) - Verbesserte Brandklasse

Article number	Coil / Pallet	Type	Pallet dimension (mm)
50-ISO13-16-BL-BSD	50 m / 400 m	16x2 blue	800x800
50-ISO13-16-RO-BSD	50 m / 400 m	16x2 red	800x800
50-ISO13-20-BL-BSD	50 m / 400 m	20x2 blue	800x800
50-ISO13-20-RO-BSD	50 m / 400 m	20x2 red	800x800
50-ISO13-26-BL-BSD	50 m / 300 m	26x3 blue	800x800
50-ISO13-26-RO-BSD	50 m / 300 m	26x3 red	800x800
25-ISO13-32-BL-BSD	25 m / 200 m	32x3 blue	800x800
25-ISO13-32-RO-BSD	25 m / 200 m	32x3 red	800x800

Type: ISO20 BSD (20 mm) **Fireclass: BL, s1-d0**



Henco tube pre-insulated Standard (20mm) - Improved fire class
Henco voorgeïsoleerde buis Standaard (20mm) - verbeterde brandklasse
Henco tube pre-insulated Standard (20mm) - meilleur classement au feu
Henco Rohr Isoliert Standard (20mm) - Verbesserte Brandklasse

Article number	Coil / Pallet	Type	Pallet dimension (mm)
25-ISO20-32-BL-BSD	25 m / 150 m	32x3 blue	800x800
25-ISO20-32-RO-BSD	25 m / 150 m	32x3 red	800x800



Did you know...

that you can use the **hand-tearable repair tape** to almost invisibly repair the Henco pre-insulated pipes?

Find more information on **p. 180**





Henco Pipes

Standard ISO (PE-Xc/AL/PE-Xc)

- 1
- 2
- 3
- 4
- 5
- 6
- 7
- 8
- 9
- 10
- 11
- 12
- 13
- 14

Type: STANDARD PIPE IN PIPE



Henco multilayer pipe with colour coded conduit Standard (Coil)
Henco meerlagenbuis met mantel Standaard (Rol)
Henco tube multicouche avec gaine Standard (Rouleau)
Henco Mehrschichtverbundrohr mit Mantel Standard (Ring)

Article number	Coil / Pallet	Type	Pallet dimension (mm)
50-014MR	50 m / 800 m	14x2 red	1200x800
50-014MB	50 m / 800 m	14x2 blue	1200x800
25-016MR	25 m / 500 m	16x2 red	1200x800
25-016MB	25 m / 500 m	16x2 blue	1200x800
50-016MR	50 m / 800 m	16x2 red	1200x800
50-016MB	50 m / 800 m	16x2 blue	1200x800
50-016MBLACK	50 m / 800 m	16x2 black	1200x800
100-016MR	100 m / 1000 m	16x2 red	1200x800
100-016MB	100 m / 1000 m	16x2 blue	1200x800
100-016MBLACK	100 m / 1000 m	16x2 black	1200x800
50-018MR*	50 m / 800 m	18x2 red	1200x800
50-018MB*	50 m / 800 m	18x2 blue	1200x800
100-018MR*	100 m / 1000 m	18x2 blue	1200x800
100-018MB*	100 m / 1000 m	18x2 blue	1200x800
25-020MR	25 m / 500 m	20x2 red	1200x800
25-020MB	25 m / 500 m	20x2 blue	1200x800
25-020MBLACK*	25 m / 500 m	20x2 black	1200x800
50-020MR	50 m / 800 m	20x2 red	1200x800
50-020MB	50 m / 800 m	20x2 blue	1200x800
50-020MBLACK	50 m / 800 m	20x2 black	1200x800
100-020MB	100 m / 1000 m	20x2 blue	1200x800
100-020MR	100 m / 1000 m	20x2 red	1200x800
25-026MR	25 m / 500 m	26x3 blue	1200x800
25-026MB	25 m / 500 m	26x3 blue	1200x800
50-026MR	50 m / 500 m	26x3 blue	1200x800
50-026MB	50 m / 500 m	26x3 blue	1200x800
50-026MBLACK	50 m / 500 m	26x3 black	1200x800
25-032MR	25 m / 300 m	32x3 red	900x900
25-032MB	25 m / 300 m	32x3 blue	900x900

*TILL EXHAUSTION OF STOCK

Type: STANDARD PIPE IN PIPE CSC



Henco multilayer pipe with colour coded conduit Standard (Coil small coil)
Henco meerlagenbuis met mantel Standaard (Rol kleine kern)
Henco tube multicouche avec gaine Standard (Rouleau noyau intérieure)
Henco Mehrschichtverbundrohr mit Mantel Standard (Ring kleinen Kern)

Article number	Coil / Pallet	Type	Pallet dimension (mm)
25-016MB-KB	25 m / 600 m	16x2 blue	1200x800
25-016MR-KB	25 m / 600 m	16x2 red	1200x800

internal coil diameter = 28 cm



Type: COMBI STANDARD



Henco Combi Standard (Coil)
 Henco Combi Standaard (Rol)
 Henco Combi Standard (Rouleau)
 Henco Combi Standard (Rohr)

Article number	Coil / Pallet	Type	Pallet dimension (mm)
50-COMBI16	50 m / 500 m	16x2	1200x800

Type: FLEX STANDARD



Henco Flex
 Henco Flex (Rol)
 Henco Flex (Rouleau)
 Henco Flex (Ring)

Article number	Unpacked	Type
1-FLEX32	Cut to length	32x3

Can be cut to desired meter length - up to 100m max.

- 1
- 2
- 3
- 4
- 5
- 6
- 7
- 8
- 9
- 10
- 11
- 12
- 13
- 14

Did you know...

you could use the **rubber end cap HFMAN125** to provide a watertight seal on the Henco FLEX32 ends?



Find more information on **p.180**

Type: LB



Carcassing pipe 16mm
 Dubbele radiatorbocht, 16mm, doorverbonden einde
 Double courbe radiateur, 16mm, embout fermé
 Heizkörperwinkel doppelt, 16mm, durchgestellt Ende

Article number	Bag	Type
LB50	1 pc	Ø16, centre-to-centre = 50mm

Type: ISO-BLOCK-S

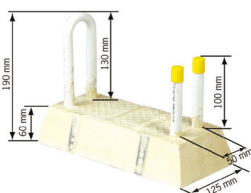

Carcassing pipe 16mm with insulation
 Dubbele radiatorbocht met isolatie, 16mm, doorverbonden einde
 Double courbe radiateur, 16mm, avec isolation, embout fermé
 Heizkörperwinkel doppelt mit Isolation, 16mm, durchgestellt Ende

Article number	Box	Type
ISO-BLOCK-S	50 pc	Ø16, centre-to-centre = 50mm



Henco Pipes

RIXc (PE-Xc/AL/PE-Xc)

Maximum working pressure (bar) for the different pipe types and diameters

Diameter (mm)	12	14	16	16	18	18	20	20	26	26	32	40	50	63	75	90
Pipe type	STA	STA	STA	RIXc	STA	RIXc	STA	RIXc	STA	RIXc	STA	STA	STA	STA	STA	STA
Max working pressure (bar)	6	10	16	10	10	10	16	10	16	10	16	10	10	10	10	10

Type: COIL RIXC



Henco multilayer pipe RIXc (Coil)

Henco meerlagenbuis RIXc (Rol)

Henco tube multicouche RIXc (Rouleau)

Henco Mehrschichtverbundrohr RIXc (Rohr)

Article number	Coil / Pallet	Type	Pallet dimension (mm)
50-R160212	50 m / 1500 m	16x2	1200x800
100-R160212	100 m / 2200 m	16x2	800x800
200-R160212	200 m / 2600 m	16x2	800x800
500-R160212	500m / 2500 m	16x2	800x800
100-R180214	100 m / 1700 m	18x2	800x800
200-R180214	200 m / 2000 m	18x2	800x800
50-R200216	50 m / 1000 m	20x2	1200x800
100-R200216	100 m / 1500 m	20x2	800x800
25-R260320	25 m / 500 m	26x3	1200x800
50-R260320	50 m / 800 m	26x3	800x800

Type: COIL RIXC CSC



Henco multilayer pipe RIXc (Coil with small core)

Henco meerlagenbuis RIXc (Rol kleine kern)

Henco tube multicouche RIXc (Petit rouleau noyau intérieure)

Henco Mehrschichtverbundrohr RIXc (Rohr kleinen Kern)

Article number	Coil / Pallet	Type	Pallet dimension (mm)
10-R160212-KB	10 m / 800 m	16x2	1200x800
15-R160212-KB	15 m / 900 m	16x2	1200x800
25-R160212-KB	25 m / 1125 m	16x2	1200x800
25-R200216-KB	25 m / 900 m	20x2	1200x800

internal coil diameter = 28 cm

Type: STRAIGHT LENGTH RIXC



Henco multilayer pipe RIXc (Straight length)

Henco meerlagenbuis RIXc (Stang)

Henco tube multicouche RIXc (Barre)

Henco Mehrschichtverbundrohr RIXc (Stange)

Article number	Cylinder / Pallet	Type	Pallet dimension (mm)
03-R160212	75 m / 3600 m	16x2	4000x705
04-R160212	100 m / 4800 m	16x2	4100x705
05-R160212	125 m / 6000 m	16x2	5100x705
03-R200216	54 m / 2592 m	20x2	4000x705
04-R200216	72 m / 3456 m	20x2	4100x705
05-R200216	90 m / 4320 m	20x2	5100x705
03-R260320	30 m / 1440 m	26x3	4000x705
04-R260320	40 m / 1920 m	26x3	4100x705
05-R260320	50 m / 2400 m	26x3	5100x705



Type: ISO4 (6 mm) RIXC **Fireclass: CL, s1-d0**



Henco tube pre-insulated RIXc (6mm)
Henco voorgeïsoleerde buis RIXc (6mm)
Henco tube pré-isolé RIXc (6mm)
Henco Rohr Isoliert RIXc (6mm)

Article number	Coil / Pallet	Type	Pallet dimension (mm)
50-ISO4-R16-BL	50 m / 800 m	16x2 blue	800x800
50-ISO4-R16-RO	50 m / 800 m	16x2 red	800x800
100-ISO4-R16-BL	100 m / 900 m	16x2 blue	800x800
100-ISO4-R16-RO	100 m / 900 m	16x2 red	800x800
50-ISO4-R18-BL	50 m / 650 m	18x2 blue	800x800
50-ISO4-R18-RO	50 m / 650 m	18x2 red	800x800
50-ISO4-R20-BL	50 m / 700 m	20x2 blue	800x800
50-ISO4-R20-RO	50 m / 700 m	20x2 red	800x800
25-ISO4-R26-BL	25 m / 300 m	26x3 blue	800x800
25-ISO4-R26-RO	25 m / 300 m	26x3 red	800x800
50-ISO4-R26-BL	50 m / 500 m	26x3 blue	800x800
50-ISO4-R26-RO	50 m / 500 m	26x3 red	800x800

Type: ISO4 BSD (6 mm) RIXC **Fireclass: BL, s1-d0**



Henco tube pre-insulated RIXc (6mm) – Improved fire class
Henco voorgeïsoleerde buis RIXc (6mm) – verbeterde brandklasse
Henco tube pré-isolé RIXc (6mm) – meilleur classement au feu
Henco Rohr Isoliert RIXc (6mm) – Verbesserte Brandklasse

Article number	Coil / Pallet	Type	Pallet dimension (mm)
25-ISO4-R16-BL-BSD	25 m / 250 m	16x2 blue	800x800
25-ISO4-R16-RO-BSD	25 m / 250 m	16x2 red	800x800
50-ISO4-R16-BL-BSD	50 m / 800 m	16x2 blue	800x800
50-ISO4-R16-RO-BSD	50 m / 800 m	16x2 red	800x800
100-ISO4-R16-BL-BSD	100 m / 900 m	16x2 blue	800x800
100-ISO4-R16-RO-BSD	100 m / 900 m	16x2 red	800x800
50-ISO4-R18-BL-BSD	50 m / 650 m	18x2 blue	800x800
50-ISO4-R18-RO-BSD	50 m / 650 m	18x2 red	800x800
50-ISO4-R20-BL-BSD	50 m / 700 m	20x2 blue	800x800
50-ISO4-R20-RO-BSD	50 m / 700 m	20x2 red	800x800
25-ISO4-R26-BL-BSD	25 m / 300 m	26x3 blue	800x800
25-ISO4-R26-RO-BSD	25 m / 300 m	26x3 red	800x800
50-ISO4-R26-BL-BSD	50 m / 500 m	26x3 blue	800x800
50-ISO4-R26-RO-BSD	50 m / 500 m	26x3 red	800x800



Did you know...

that you can use the **hand-tearable repair tape** to almost invisibly repair the Henco pre-insulated pipes?

Find more information on **p. 180**





Henco Pipes

RIXc ISO (PE-Xc/AL/PE-Xc)

- 1
- 2
- 3
- 4
- 5
- 6
- 7
- 8
- 9
- 10
- 11
- 12
- 13
- 14

Type: ISO9 (10 mm) RIXc Fireclass: CL, s1-d0



Henco tube pre-insulated RIXc (10mm)
Henco voorgeïsoleerde buis RIXc (10mm)
Henco tube pré-isolé RIXc (10mm)
Henco Rohr Isoliert RIXc (10mm)

Article number	Coil / Pallet	Type	Pallet dimension (mm)
50-ISO9-R16-RO	50 m / 600 m	16x2 red	800x800
50-ISO9-R16-BL	50 m / 600 m	16x2 blue	800x800
50-ISO9-R20-RO	50 m / 400 m	20x2 red	800x800
50-ISO9-R20-BL	50 m / 400 m	20x2 blue	800x800
25-ISO9-R26-RO	25 m / 325 m	26x3 red	800x800
25-ISO9-R26-BL	25 m / 325 m	26x3 blue	800x800
50-ISO9-R26-BL	50 m / 400 m	26x3 blue	800x800
50-ISO9-R26-RO	50 m / 400 m	26x3 red	800x800

Type: ISO9BSD (10mm) RIXc Fireclass: BL, s1-d0



Henco tube pre-insulated RIXc (10mm) - Improved fire class
Henco voorgeïsoleerde buis RIXc (10mm) - verbeterde brandklasse
Henco tube pré-isolé RIXc (10mm) - meilleur classement au feu
Henco Rohr Isoliert RIXc (10mm) - Verbesserte Brandklasse

Article number	Coil / Pallet	Type	Pallet dimension (mm)
50-ISO9-R16-BL-BSD	50 m / 600 m	16x2 blue	800x800
50-ISO9-R16-RO-BSD	50 m / 600 m	16x2 red	800x800
50-ISO9-R20-BL-BSD	50 m / 400 m	20x2 blue	800x800
50-ISO9-R20-RO-BSD	50 m / 400 m	20x2 red	800x800
25-ISO9-R26-BL-BSD	25 m / 325 m	26x3 blue	800x800
25-ISO9-R26-RO-BSD	25 m / 325 m	26x3 red	800x800
50-ISO9-R26-BL-BSD	50 m / 400 m	26x3 blue	800x800
50-ISO9-R26-RO-BSD	50 m / 400 m	26x3 red	800x800

Type: ISO13 (13 mm) RIXc Fireclass: CL, s1-d0



Henco tube pre-insulated RIXc (13mm)
Henco voorgeïsoleerde buis RIXc (13mm)
Henco tube pré-isolé RIXc (13mm)
Henco Rohr Isoliert RIXc (13mm)

Article number	Coil / Pallet	Type	Pallet dimension (mm)
50-ISO13-R16-BL	50 m / 400 m	16x2 blue	800x800
50-ISO13-R16-RO	50 m / 400 m	16x2 red	800x800
50-ISO13-R20-BL	50 m / 400 m	20x2 blue	800x800
50-ISO13-R20-RO	50 m / 400 m	20x2 red	800x800
50-ISO13-R26-BL	50 m / 300 m	26x3 blue	800x800
50-ISO13-R26-RO	50 m / 300 m	26x3 red	800x800



Type: ISO13BSD (13mm) RIXc **Fireclass: BL, s1-d0**



Henco tube pre-insulated RIXc (13mm) – Improved fire class
 Henco voorgeïsoleerde buis RIXc (13mm) – verbeterde brandklasse
 Henco tube pré-isolé RIXc (13mm) – meilleur classement au feu
 Henco Rohr Isoliert RIXc (13mm) – Verbesserte Brandklasse

Article number	Coil / Pallet	Type	Pallet dimension (mm)
50-ISO13-R16-BL-BSD	50 m / 400 m	16x2 blue	800x800
50-ISO13-R16-RO-BSD	50 m / 400 m	16x2 red	800x800
50-ISO13-R20-BL-BSD	50 m / 400 m	20x2 blue	800x800
50-ISO13-R20-RO-BSD	50 m / 400 m	20x2 red	800x800
50-ISO13-R26-BL-BSD	50 m / 300 m	26x3 blue	800x800
50-ISO13-R26-RO-BSD	50 m / 300 m	26x3 red	800x800

Type: ISO20 (20mm) RIXc **Fireclass: CL, s1-d0**



Henco tube pre-insulated RIXc (20mm)
 Henco voorgeïsoleerde buis RIXc (20mm)
 Henco tube pré-isolé RIXc (20mm)
 Henco Rohr Isoliert RIXc (20mm)

Article number	Coil / Pallet	Type	Pallet dimension (mm)
50-ISO20-R16-BL	50 m / 250 m	16x2 blue	800x800
50-ISO20-R16-RO	50 m / 250 m	16x2 red	800x800
50-ISO20-R20-BL	50 m / 250 m	20x2 blue	800x800
50-ISO20-R20-RO	50 m / 250 m	20x2 red	800x800
25-ISO20-R26-BL	25 m / 175 m	26x3 blue	800x800
25-ISO20-R26-RO	25 m / 175 m	26x3 red	800x800

Type: ISO20BSD (20mm) RIXc **Fireclass: BL, s1-d0**



Henco tube pre-insulated RIXc (20mm) – Improved fire class
 Henco voorgeïsoleerde buis RIXc (20mm) – verbeterde brandklasse
 Henco tube pre-insulated RIXc (20mm) – meilleur classement au feu
 Henco Rohr Isoliert RIXc (20mm) – Verbesserte Brandklasse

Article number	Coil / Pallet	Type	Pallet dimension (mm)
50-ISO20-R16-BL-BSD	50 m / 250 m	16x2 blue	800x800
50-ISO20-R16-RO-BSD	50 m / 250 m	16x2 red	800x800
50-ISO20-R20-BL-BSD	50 m / 250 m	20x2 blue	800x800
50-ISO20-R20-RO-BSD	50 m / 250 m	20x2 red	800x800
25-ISO20-R26-BL-BSD	25 m / 175 m	26x3 blue	800x800
25-ISO20-R26-RO-BSD	25 m / 175 m	26x3 red	800x800



Did you know...

that you can use the **hand-tearable repair tape** to almost invisibly repair the Henco pre-insulated pipes?

Find more information on **p. 180**





Henco Pipes

RIXc ISO (PE-Xc/AL/PE-Xc)

- 1
- 2
- 3
- 4
- 5
- 6
- 7
- 8
- 9
- 10
- 11
- 12
- 13

Type: COMBI ISO4 RIXc Fireclass: CL, s1-d0



Henco Combi ISO RIXc (Coil)
 Henco Combi ISO RIXc (Rol)
 Henco Combi ISO RIXc (Rouleau)
 Henco Combi ISO RIXc (Ring)

Article number	Coil / Pallet	Type	Pallet dimension (mm)
50-ISO4-COMBI16R	50 m / 400 m	16x2	800x800

Type: RIXc PIPE IN PIPE



Henco tube with colour coded conduit RIXc
 Henco buis met mantel RIXc
 Henco tube avec gaine RIXc
 Henco Rohr mit Mantel RIXc

Article number	Coil / Pallet	Type	Pallet dimension (mm)
25-R16MB	25 m / 500 m	16x2 blue	1200x800
25-R16MR	25 m / 500 m	16x2 red	1200x800
50-R16MB	50 m / 1000 m	16x2 blue	1200x800
50-R16MR	50 m / 1000 m	16x2 red	1200x800
50-R16MBLACK	50 m / 1000 m	16x2 black	1200x800
100-R16MB	100 m / 1000 m	16x2 blue	1200x800
100-R16MR	100 m / 1000 m	16x2 red	1200x800
100-R16MBLACK*	100 m / 1000 m	16x2 black	1200x800
50-R18MB	50 m / 800 m	18x2 blue	1200x800
50-R18MR	50 m / 800 m	18x2 red	1200x800
25-R20MB	25 m / 500 m	20x2 blue	1200x800
25-R20MR	25 m / 500 m	20x2 red	1200x800
25-R20MBLACK*	25 m / 800 m	20x2 black	1200x800
50-R20MB	50 m / 800 m	20x2 blue	1200x800
50-R20MR	50 m / 800 m	20x2 red	1200x800
100-R20MB	100 m / 1000 m	20x2 blue	1200x800
100-R20MR	100 m / 1000 m	20x2 red	1200x800
50-R26MB	50 m / 500 m	26x3 blue	1200x800
50-R26MR	50 m / 500 m	26x3 red	1200x800

**TILL EXHAUSTION OF STOCK*

Type: COMBI RIXc



Henco Combi RIXc (Coil)
 Henco Combi RIXc (Rol)
 Henco Combi RIXc (Rouleau)
 Henco Combi RIXc (Rohr)

Article number	Coil / Pallet	Type	Pallet dimension (mm)
50-COMBI16R	50 m / 500 m	16x2	1200x800



Type: FLOOR-RIXc



Henco multilayer pipe (Coil)
Henco meerlagenbuis (Rol)
Henco tube multicouche (Rouleau)
Henco Mehrschichtverbundrohr (Ring)

Article number	Coil / Pallet	Type	Pallet dimension (mm)
100-F16R-WZ	100 m / 2200 m	16x2	800x800
200-F16R-WZ	200 m / 2600 m	16x2	800x800
500-F16R-WZ	500 m / 1500 m	16x2	800x800
100-F20R-WZ	100 m / 1000 m	20x2	800x800

1

2

3

4

5

6

7

8

9

10

11

12

13



Henco Pipes

PE-Xc

1 Type: 5L PE-Xc



Henco 5L PE-Xc pipe PE-Xc/EVOH/PE-Xc (Coil)
 Henco 5L PE-Xc buis PE-Xc/EVOH/PE-Xc (Rol)
 Henco 5L PE-Xc tube PE-Xc/EVOH/PE-Xc (Rouleau)
 Henco 5L PE-Xc Rohr PE-Xc/EVOH/PE-Xc (Ring)

Article number	Coil / Pallet	Type	Pallet dimension (mm)
200-PXC1620	200 m / 1600 m	16x2	800x800
600-PXC1620	600 m / 2400 m	16x2	800x800
200-PXC1720	200 m / 2000 m	17x2	800x800
600-PXC1720	600 m / 2400 m	17x2	800x800
240-PXC1820	240 m / 2160 m	18x2	800x800
200-PXC2020	200 m / 1000 m	20x2	800x800
600-PXC2020	600 m / 1200 m	20x2	800x800

10 Type: 1L PE-Xc

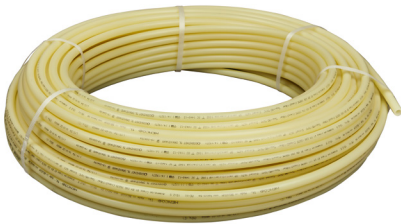

Henco 1L PE-Xc pipe (Coil)
 Henco 1L PE-Xc buis (Rol)
 Henco 1L PE-Xc tube (Rouleau)
 Henco 1L PE-Xc Rohr (Ring)

Article number	Coil / Pallet	Type	Pallet dimension (mm)
50-MXC1620	50 m / 500 m	16X2	750x750



Type: 5L PE-RT



Henco 5L PE-RT pipe PE-RT/EVOH/PE-RT (Coil)
Henco 5L PE-RT buis PE-RT/EVOH/PE-RT (Rol)
Henco 5L PE-RT tube PE-RT/EVOH/PE-RT (Rouleau)
Henco 5L PE-RT Rohr PE-RT/EVOH/PE-RT (Ring)

Article number	Coil / Pallet	Type	Pallet dimension (mm)
600-PRT1420	600 m / 2400 m	14x2	800x800
120-PRT1620-234	120 m / 1440 m	16x2	800x800
270-PRT1620-234	270 m / 2160 m	16x2	800x800
640-PRT1620-234	640 m / 2560 m	16x2	800x800
600-PRT1720-234	600 m / 2400 m	17x2	800x800
240-PRT1820-234	240 m / 1440 m	18x2	800x800
600-PRT1820-234	600 m / 1800 m	18x2	800x800
600-PRT2020-234	600 m / 1800 m	20x2	800x800

1

2

3

4

5

6

7

8

9

10

11

12

13

14



Henco Pipes

Protection Hose

1

Type: PROTECTION HOSE



Henco colour coded conduit (Coil)

Henco mantel (Rol)

Henco gaine (Rouleau)

Henco Mantel (Ring)

Article number	Coil / Pallet	Type	Pallet dimension (mm)
100-MB	100 m / 2400 m	Ø14/Ø16/Ø18 blue	1200x800
100-MR	100 m / 2400 m	Ø14/Ø16/Ø18 red	1200x800
100-MBLACK	100 m / 2400 m	Ø14/Ø16/Ø18 black	1200x800
50-MB20	50 m / 1800 m	Ø20 blue	1200x800
50-MR20	50 m / 1800 m	Ø20 red	1200x800
50-MBLACK20	50 m / 1800 m	Ø20 black	1200x800
50-MB26	50 m / 1200 m	Ø26 blue	1200x800
50-MR26	50 m / 1200 m	Ø26 red	1200x800
50-MBLACK26	50 m / 1200 m	Ø26 black	1200x800
25-MB32	25 m / 500 m	Ø32 blue	1200x800
25-MR32	25 m / 500 m	Ø32 red	1200x800
25-MBLACK32	25 m / 500 m	Ø32 black	1200x800

2

3

4

5

6

7

8

9

10

11

12

13

14

Type: PROTECTION HOSE GAS



Colour coded conduit GAS (Coil)

Mantel GAS (Rol)

Gaine GAS (Rouleau)

Mantel GAS (Ring)

Article number	Coil / Pallet	Type	Pallet dimension (mm)
50-MG16	50 m / 2400 m	Ø16 yellow	1200x800
100-MG16	100 m / 2400 m	Ø16 yellow	1200x800
50-MG20	50 m / 1800 m	Ø20 yellow	1200x800
50-MG26	50 m / 1200 m	Ø26 yellow	1200x800
25-MG32	25 m / 500 m	Ø32 yellow	1200x800



Gas: only allowed in countries where a HENCO GAS testing + certificate is available! (see www.henco.be)

Gas: enkel toegelaten in landen waar er een HENCO GAS keur is + een certificaat voorhanden is! (zie www.henco.be)

Gaz: seulement permis dans des pays où le contrôle a eu lieu + certificat est disponible! (Consultez www.henco.be)

Gas: nur zugelassen in Länder wo HENCO GAS Prüfung geschehen ist + Zertifikat vorhanden ist! (Siehe www.henco.be)

Type: COIL GAS



Henco multilayer pipe GAS (Coil)
Henco meerlagenbuis GAS (Rol)
Henco tube multicouche GAZ (Rouleau)
Henco Mehrschichtverbundrohr GAS (Rohr)

Article number	Coil / Pallet	Type	Pallet dimension (mm)
50-260320-GAS	50 m / 800 m	26x3	750x750

Type: STRAIGHT LENGTH GAS



Henco multilayer pipe GAS (Straight length)
Henco meerlagenbuis GAS (Stang)
Henco tube multicouche GAZ (Rouleau)
Henco Mehrschichtverbundrohr GAS (Stange)

Article number	Cylinder / Pallet	Type	Pallet dimension (mm)
05-160212-GAS	125 m / 6000 m	16x2	5100x705
05-200216-GAS	90 m / 4320 m	20x2	5100x705
05-260320-GAS	50 m / 2400 m	26x3	5100x705
05-320326-GAS	35 m / 1680 m	32x3	5100x705

Type: GAS PIPE IN PIPE



Henco multilayer piper with colour coded conduit GAS (Coil)
Henco meerlagenbuis met mantel GAS (Rol)
Henco tube multicouche avec gaine GAZ (Rouleau)
Henco Mehrschichtverbundrohr mit Mantel GAS (Ring)

Article number	Coil / Pallet	Type	Pallet dimension (mm)
25-016GASMG	25 m / 500 m	16x2	1200x800
50-016GASMG	50 m / 800 m	16x2	1200x800
25-020GASMG	25 m / 500 m	20x2	1200x800
50-020GASMG	50 m / 800 m	20x2	1200x800
25-026GASMG	25 m / 500 m	26x3	1200x800
50-026GASMG	50 m / 500 m	26x3	1200x800
25-032GASMG	25 m / 300 m	32x3	1200x800



Gastec QA: Standard pipe gas in combination with Henco press fittings synthetic for gas, see page 47.



IT-DT-Ki0410

Kiwa Uni: Standard pipe gas in combination with Henco brass press fittings for gas, see page 95.



Henco Pipes

Sprinkler Standard (PE-Xc/AL/PE-Xc)



Sprinkler: only allowed in countries where a Henco Sprinkler certificate is available!
(see www.henco.be)

Sprinkler: seulement permis dans des pays où le Henco Sprinkler certificat est disponible!
(Consultez www.henco.be)

Sprinkler: enkel toegelaten in landen waar er een Henco Sprinkler certificaat voorhanden is!
(zie www.henco.be)

Sprinkler: nur zugelassen in Länder wo Henco Sprinkler Zertifikat vorhanden ist!
(Siehe www.henco.be)

Type: COIL SPRINKLER



Henco multilayer pipe Sprinkler (Coil)
Henco meerlagenbuis Sprinkler (rol)
Henco tube multicouche Sprinkler (Rouleau)
Henco Mehrschichtverbundrohr Sprinkler (Rohr)

Article number	Coil / Pallet	Type	Pallet dimension (mm)
50-320326-SPR	50 m / 650 m	32x3	900x900

Type: STRAIGHT LENGTH SPRINKLER



Henco multilayer pipe Sprinkler (Straight length)
Henco meerlagenbuis Sprinkler (Stang)
Henco tube multicouche Sprinkler (Barre)
Henco Mehrschichtverbundrohr Sprinkler (Stange)

Article number	Cylinder / Pallet	Type	Pallet dimension (mm)
05-320326-SPR	35 m / 1680 m	32x3	5100x705
05-403533-SPR	45 m / 1080 m	40x3,5	5100x705
05-504042-SPR	35 m / 840 m	50x4	5100x705
05-634554-SPR	20 m / 480 m	63x4,5	5100x705

Standard pipe Sprinkler in combination with Henco press fittings synthetic for Sprinkler, see page **182**
Sprinkler Cup: see **chapter 14** on Sprinkler systems



The VdS seal stands for reliable and long-term effectiveness, which has been tested in comprehensive endurance tests and according to practical VdS guidelines (including DIN/EN and all CEA requirements). VdS-approved products ensure not only the greatest possible protection but also high savings through minimised false alarms, less maintenance and tested durability. VdS product certification is therefore an excellent basis for being perceived as a premium supplier on the market for fire protection and security technology.



Henco Press

	<i>Page</i>
<i>Henco Press Black</i>	<i>26</i>
<i>Henco Press White</i>	<i>38</i>
<i>Henco Press Gas</i>	<i>47</i>
<i>Henco Press SUPER SIZES</i>	<i>52</i>
<i>Henco Ecoline</i>	<i>66</i>



Henco Press

Henco Press Black

SUPERSIZES (75/90 mm) **p. 62**

Type: 1PK



Elbow 90°
Knie 90°
Coude 90°
Winkel 90°

Article number	Bag / Box	Type
1PK-1414	10 pc / 150 pc	14x14
1PK-1616	10 pc / 120 pc	16x16
1PK-1818	10 pc / 100 pc	18x18
1PK-2020	10 pc / 80 pc	20x20
1PK-2626	5 pc / 50 pc	26x26
1PK-3232	5 pc / 30 pc	32x32
1PK-4040	5 pc / 20 pc	40x40
1PK-5050	1 pc / 8 pc	50x50
1PK-6363	1 pc / 6 pc	63x63

Type: 1PK-JG



Elbow 90° 16x10JG (ceiling cooling)
Knie 90° 16x10JG (koelplafond)
Coude 90° 16x10JG (plafond climatisé)
Winkel 90° 16x10JG (Klimadecke)

Article number	Bag / Box	Type
1PK-20JG10	10 pc / 100 pc	20x10JG

Type: 2PK (CW617N)



Backplate elbow female
Sanitair muurplaat binnendraad
Culasse pour sanitaire
Sanitär Wandscheibe IG

Article number	Bag / Box	Type
2PK-1404BP	10 pc / 50 pc	14x1/2" (56 mm)
2PK-1603	10 pc / 50 pc	16x3/8" (56 mm)
2PK-1604BP	10 pc / 50 pc	16x1/2" (56 mm)
2PK-1804BP	10 pc / 50 pc	18x1/2" (56 mm)
2PK-2004BP	10 pc / 50 pc	20x1/2" (56 mm)
2PK-2005	5 pc / 30 pc	20x3/4" (61 mm)
2PK-2605	5 pc / 30 pc	26x3/4" (66 mm)

Type: 2PK-K (CW617N)



Backplate elbow female, short model
Sanitair muurplaat binnendraad, laag
Culasse double pour sanitaire, modèle court
Sanitär Wandscheibe IG, kurzes Modell

Article number	Bag / Box	Type
2PK-1604KBP	10 pc / 50 pc	16x1/2" (41 mm)



Type: 2PK-X (316 L INOX)



Backplate elbow female INOX
Sanitair muurplaat binnendraad INOX
Culasse pour sanitaire INOX
Sanitär Wandscheibe IG INOX

Article number	Bag / Box	Type
2PK-1404-X	10 pc / 50 pc	14x1/2" (56 mm)
2PK-1604-X	10 pc / 50 pc	16x1/2" (56 mm)
2PK-1804-X	10 pc / 50 pc	18x1/2" (56 mm)
2PK-2004-X	10 pc / 50 pc	20x1/2" (56 mm)
2PK-2005-X	5 pc / 30 pc	20x3/4" (61 mm)
2PK-2605-X	5 pc / 30 pc	26x3/4" (66 mm)

Type: 2PK-K-X (316 L INOX)



Backplate elbow female, short model INOX
Sanitair muurplaat binnendraad, laag, INOX
Culasse double pour sanitaire, modèle court INOX
Sanitär Wandscheibe IG, kurzes Modell INOX

Article number	Bag / Box	Type
2PK-1604K-X	10 pc / 50 pc	16x1/2" (41 mm)

Did you know...

you could use our **galvanised bracket plates** for the 2PK, 2PK-X and 2PK-K fittings?

Find more information on **p. 179**



Type: 3PK (CW617N)



Double backplate elbow female, short model
Sanitair muurplaat binnendraad dubbel, laag
Culasse double pour sanitaire, modèle court
Sanitär Wandscheibe doppelt IG, kurzes Modell

Article number	Bag / Box	Type
3PK-160416BP	10 pc / 30 pc	16x1/2"x16 (43,5 mm)
3PK-200420BP	10 pc / 30 pc	20x1/2"x20 (43,5 mm)

Type: 3PK-X (316 L INOX)



Double backplate elbow female, short model INOX
Sanitair muurplaat binnendraad dubbel INOX
Culasse double pour sanitaire, modèle court INOX
Sanitär Wandscheibe doppelt IG, kurzes Modell INOX

Article number	Bag / Box	Type
3PK-160416-X	10 pc / 30 pc	16x1/2"x16 (43,5 mm)
3PK-200420-X	10 pc / 30 pc	20x1/2"x20 (43,5 mm)



Henco Press

Henco Press Black

Type: BP04

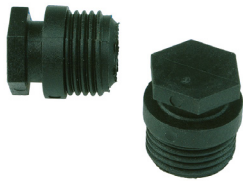

Black plug for 1/2" female nipple
 Zwarte stop voor 1/2"
 Bouchon noir pour 1/2" nipple femelle
 Schwarzen Stopf für 1/2" Nippel

Article number	Bag / Box	Type
BPO4	50 pc / 500 pc	1/2"

Not suited for testing

SUPERSIZES (75 mm) p. 61

Type: 5PK (CW617N)



Elbow 90° male adapter
 Knie 90° buitendraad
 Coude 90° mâle
 Winkel 90° AG

Article number	Bag / Box	Type
5PK-1404	10 pc / 60 pc	14x1/2"
5PK-1604	10 pc / 60 pc	16x1/2"
5PK-1804	10 pc / 60 pc	18x1/2"
5PK-2004	10 pc / 60 pc	20x1/2"
5PK-2005	10 pc / 50 pc	20x3/4"
5PK-2605	10 pc / 40 pc	26x3/4"
5PK-3206	5 pc / 20 pc	32x1"
5PK-4007	3 pc / 15 pc	40x5/4"
5PK-5007	1 pc / 10 pc	50x5/4"
5PK-5008	1 pc / 8 pc	50x6/4"
5PK-6310	1 pc / 4 pc	63x2"

SUPERSIZES (75 mm) p. 61

Type: 5PK-N (CW602N)



Elbow 90° male adapter
 Knie 90° buitendraad
 Coude 90° mâle
 Winkel 90° AG

Article number	Bag / Box	Type
5PK-4007-N	3 pc / 15 pc	40x5/4"
5PK-5007-N*	1 pc / 10 pc	50x5/4"
5PK-5008-N	1 pc / 8 pc	50x6/4"
5PK-6310-N	1 pc / 4 pc	63x2"

*TILL EXHAUSTION OF STOCK

SUPERSIZES (75/90 mm) p. 61

Type: 6PK (CW617N)



Elbow 90° female adapter
 Knie 90° binnendraad
 Coude 90° femelle
 Winkel 90° IG

Article number	Bag / Box	Type
6PK-1404BP	10 pc / 60 pc	14x1/2"
6PK-1603	10 pc / 60 pc	16x3/8"
6PK-1604BP	10 pc / 60 pc	16x1/2"
6PK-1804BP	10 pc / 60 pc	18x1/2"
6PK-2004BP	10 pc / 60 pc	20x1/2"
6PK-2005	10 pc / 50 pc	20x3/4"
6PK-2605	10 pc / 50 pc	26x3/4"
6PK-3206	5 pc / 20 pc	32x1"
6PK-4007	5 pc / 15 pc	40x5/4"
6PK-5007	1 pc / 8 pc	50x5/4"
6PK-5008	1 pc / 8 pc	50x6/4"
6PK-6310	1 pc / 4 pc	63x2"



Type: 6PK-N (CW602N) 



Elbow 90° female adapter
Knie 90° binnendraad
Coude 90° femelle
Winkel 90° IG

Article number	Bag / Box	Type
6PK-4007-N	5 pc / 15 pc	40x5/4"
6PK-5007-N*	1 pc / 8 pc	50x5/4"
6PK-5008-N*	1 pc / 8 pc	50x6/4"
6PK-6310-N*	1 pc / 4 pc	63x2"

**TILL EXHAUSTION OF STOCK*

Type: 6PK-X (INOX 316 L) 



Elbow 90° female adapter INOX
Knie 90° binnendraad INOX
Coude 90° femelle INOX
Winkel 90° IG INOX

Article number	Bag / Box	Type
6PK-1404-X	10 pc / 60 pc	14x1/2"
6PK-1604-X	10 pc / 60 pc	16x1/2"
6PK-1804-X	10 pc / 60 pc	18x1/2"
6PK-2004-X	10 pc / 60 pc	20x1/2"
6PK-2005-X	10 pc / 50 pc	20x3/4"
6PK-2605-X	10 pc / 50 pc	26x3/4"
6PK-3206-X	5 pc / 20 pc	32x1"
6PK-4007-X	5 pc / 15 pc	40x5/4"
6PK-5007-X	1 pc / 8 pc	50x5/4"
6PK-5008-X	1 pc / 8 pc	50x6/4"
6PK-6310-X	1 pc / 4 pc	63x2"

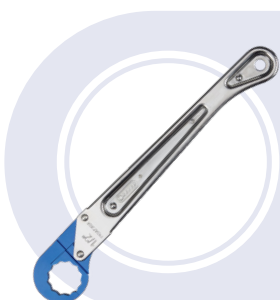

Did you know...

you could use the **PK-tool wrench** for PK and SK fittings to realise an even quicker installation of threaded Henco fittings.

Find more information on **p. 175**





Henco Press

Henco Press Black

Type: 9PK

SUPERSIZES (75/90 mm) p. 62



T-piece
T-stuk
Pièce en T
T-Stück

Article number	Bag / Box	Type
9PK-141414	10 pc / 100 pc	14x14x14
9PK-161616	10 pc / 60 pc	16x16x16
9PK-181818	10 pc / 60 pc	18x18x18
9PK-202020	10 pc / 50 pc	20x20x20
9PK-262626	5 pc / 30 pc	26x26x26
9PK-323232	5 pc / 15 pc	32x32x32
9PK-404040	5 pc / 10 pc	40x40x40
9PK-505050	1 pc / 6 pc	50x50x50
9PK-636363	1 pc / 3 pc	63x63x63

Type: 10PK

SUPERSIZES (75/90 mm) p. 62



T-reduced centre
T-verlopend
Pièce en T réduit
T-reduziert

Article number	Bag / Box	Type
10PK-161416	10 pc / 50 pc	16x14x16
10PK-181418*	10 pc / 50 pc	18x14x18
10PK-181618	10 pc / 50 pc	18x16x18
10PK-201420	10 pc / 50 pc	20x14x20
10PK-201620	10 pc / 50 pc	20x16x20
10PK-201820	10 pc / 50 pc	20x18x20
10PK-261626	5 pc / 30 pc	26x16x26
10PK-261826	5 pc / 30 pc	26x18x26
10PK-262026	5 pc / 30 pc	26x20x26
10PK-321632	5 pc / 25 pc	32x16x32
10PK-321832	5 pc / 25 pc	32x18x32
10PK-322032	5 pc / 25 pc	32x20x32
10PK-322632	5 pc / 20 pc	32x26x32
10PK-401640	5 pc / 15 pc	40x16x40
10PK-402040	5 pc / 15 pc	40x20x40
10PK-402640	5 pc / 15 pc	40x26x40
10PK-403240	5 pc / 10 pc	40x32x40
10PK-502050	1 pc / 6 pc	50x20x50
10PK-502650	1 pc / 8 pc	50x26x50
10PK-503250	1 pc / 8 pc	50x32x50
10PK-504050	1 pc / 6 pc	50x40x50
10PK-632663	1 pc / 4 pc	63x26x63
10PK-633263	1 pc / 3 pc	63x32x63
10PK-634063	1 pc / 3 pc	63x40x63
10PK-635063	1 pc / 3 pc	63x50x63

***TILL EXHAUSTION OF STOCK**



Type: 10PK-JG



T-reduced centre (ceiling cooling)
T-verlopend (koelplafond)
Pièce en T-réduit (plafond climatisé)
T-reduziert (Klimadecke)

Article number	Bag / Box	Type
10PK-20JG1020	10 pc / 50 pc	20x10JGx20

Type: 11PK



T-branch and line reduced
T-2x verlopend
Pièce en T 2x réduit
T-2x reduziert

Article number	Bag / Box	Type
11PK-161414	10 pc / 50 pc	16x14x14
11PK-181616	10 pc / 50 pc	18x16x16
11PK-201616	10 pc / 50 pc	20x16x16
11PK-201818	10 pc / 50 pc	20x18x18
11PK-202016	10 pc / 50 pc	20x20x16
11PK-261616	10 pc / 50 pc	26x16x16
11PK-261620	5 pc / 30 pc	26x16x20
11PK-262016	5 pc / 30 pc	26x20x16
11PK-262020	5 pc / 30 pc	26x20x20
11PK-262616	5 pc / 30 pc	26x26x16
11PK-262620	5 pc / 30 pc	26x26x20
11PK-322026	5 pc / 20 pc	32x20x26
11PK-322626	5 pc / 20 pc	32x26x26
11PK-402032	5 pc / 15 pc	40x20x32
11PK-402632	5 pc / 15 pc	40x26x32
11PK-403232	5 pc / 10 pc	40x32x32
11PK-404026	5 pc / 10 pc	40x40x26
11PK-404032	5 pc / 10 pc	40x40x32
11PK-502040*	1 pc / 10 pc	50x20x40
11PK-502640	1 pc / 10 pc	50x26x40
11PK-503240	1 pc / 10 pc	50x32x40
11PK-504040	1 pc / 8 pc	50x40x40

SUPERSIZES (75/90 mm) p. 63

Type: 12PK



T-enlarged branch
T-vergroot
Pièce en T agrandi
T-erweitert

Article number	Bag / Box	Type
12PK-161816*	10 pc / 50 pc	16x18x16
12PK-162016	10 pc / 50 pc	16x20x16
12PK-202620	5 pc / 30 pc	20x26x20
12PK-263226	5 pc / 20 pc	26x32x26
12PK-324032	5 pc / 15 pc	32x40x32
12PK-405040	1 pc / 8 pc	40x50x40

***TILL EXHAUSTION OF STOCK**
SUPERSIZES (32/40/50/63/75 mm) p. 63

***TILL EXHAUSTION OF STOCK**



Henco Press

Henco Press Black

Type: 13PK (CW617N) 

SUPERSIZES (75/90 mm) p. 63

1

2

3

4

5

6

7

8

9

10

11

12

13

14



T-female centre
T-binnendraad
Pièce en T femelle
T-IG

Article number	Bag / Box	Type
13PK-160416BP	10 pc / 50 pc	16x1/2"x16
13PK-180418BP	10 pc / 50 pc	18x1/2"x18
13PK-200420BP	10 pc / 50 pc	20x1/2"x20
13PK-200520	10 pc / 30 pc	20x3/4"x20
13PK-260420BP	5 pc / 30 pc	26x1/2"x20
13PK-260426BP	5 pc / 30 pc	26x1/2"x26
13PK-260526	5 pc / 30 pc	26x3/4"x26
13PK-320532	5 pc / 15 pc	32x3/4"x32
13PK-320632	5 pc / 10 pc	32x1"x32
13PK-320732	5 pc / 10 pc	32x5/4"x32
13PK-400540	5 pc / 10 pc	40x3/4"x40
13PK-400640	5 pc / 10 pc	40x1"x40
13PK-400740	5 pc / 10 pc	40x5/4"x40
13PK-500550	1 pc / 6 pc	50x3/4"x50
13PK-500850	1 pc / 4 pc	50x6/4"x50
13PK-631063	1 pc / 2 pc	63x2"x63

Type: 13PK-N (CW602N) 

SUPERSIZES (75/90 mm) p. 63



T-female centre
T-binnendraad
Pièce en T femelle
T-IG

Article number	Bag / Box	Type
13PK-400540-N	5 pc / 10 pc	40x3/4"x40
13PK-400640-N	5 pc / 10 pc	40x1"x40
13PK-400740-N	5 pc / 10 pc	40x5/4"x40
13PK-500550-N	1 pc / 6 pc	50x3/4"x50
13PK-500850-N	1 pc / 4 pc	50x6/4"x50
13PK-631063-N	1 pc / 2 pc	63x2"x63

Type: 13PK-X (INOX 316 L) 



T-female centre INOX
T-binnendraad INOX
Pièce en T femelle INOX
T-IG INOX

Article number	Bag / Box	Type
13PK-160416-X	10 pc / 50 pc	16x1/2"x16
13PK-180418-X	10 pc / 50 pc	18x1/2"x18
13PK-200420-X	10 pc / 50 pc	20x1/2"x20
13PK-200520-X	10 pc / 30 pc	20x3/4"x20
13PK-260420-X	5 pc / 30 pc	26x1/2"x20
13PK-260426-X	5 pc / 30 pc	26x1/2"x26
13PK-260526-X	5 pc / 30 pc	26x3/4"x26
13PK-320532-X	5 pc / 15 pc	32x3/4"x32
13PK-320632-X	5 pc / 10 pc	32x1"x32
13PK-320732-X	5 pc / 10 pc	32x5/4"x32
13PK-400540-X	5 pc / 10 pc	40x3/4"x40



Type: 13PK-X (INOX 316 L) 



T-female centre INOX
T-binnendraad INOX
Pièce en T femelle INOX
T-IG INOX

Article number	Bag / Box	Type
13PK-400640-X	5 pc / 10 pc	40x1"x40
13PK-400740-X	5 pc / 10 pc	40x5/4"x40
13PK-500550-X	1 pc / 6 pc	50x3/4"x50
13PK-500850-X	1 pc / 4 pc	50x6/4"x50
13PK-631063-X	1 pc / 2 pc	63x2"x63

Type: 14PK (CW617N) 

SUPERSIZES (75/90 mm) p. 63



T-male centre
T-buitendraad
Pièce en T mâle
T-AG

Article number	Bag / Box	Type
14PK-160416	10 pc / 50 pc	16x1/2"x16
14PK-180418*	10 pc / 50 pc	18x1/2"x18
14PK-200420	10 pc / 40 pc	20x1/2"x20
14PK-200520	10 pc / 30 pc	20x3/4"x20
14PK-260426	5 pc / 30 pc	26x1/2"x26
14PK-260526	5 pc / 25 pc	26x3/4"x26
14PK-260626	5 pc / 20 pc	26x1"x26
14PK-320532	5 pc / 15 pc	32x3/4"x32
14PK-400640	5 pc / 10 pc	40x1"x40
14PK-400740	5 pc / 10 pc	40x5/4"x40
14PK-500850	1 pc / 5 pc	50x6/4"x50
14PK-631063	1 pc / 2 pc	63x2"x63

**TILL EXHAUSTION OF STOCK*

Type: 14PK-N (CW602N) 

SUPERSIZES (75/90 mm) p. 64



T-male centre
T-buitendraad
Pièce en T mâle
T-AG

Article number	Bag / Box	Type
14PK-400640-N	5 pc / 10 pc	40x1"x40
14PK-500850-N	1 pc / 5 pc	50x6/4"x50

TILL EXHAUSTION OF STOCK



Did you know...

you could use the **PK-tool wrench** for PK and SK fittings to realise an even quicker installation of threaded Henco fittings.

Find more information on **p. 175**



Henco Press

Henco Press Black

Type: 15PK

SUPERSIZES (75/90 mm) **p. 64**



Straight coupling
Perssok
Manchon
Kupplung

Article number	Bag / Box	Type
15PK-1414	10 pc / 150 pc	14x14
15PK-1616	10 pc / 150 pc	16x16
15PK-1818	10 pc / 100 pc	18x18
15PK-2020	10 pc / 80 pc	20x20
15PK-2626	5 pc / 50 pc	26x26
15PK-3232	5 pc / 30 pc	32x32
15PK-4040	5 pc / 25 pc	40x40
15PK-5050	1 pc / 12 pc	50x50
15PK-6363	1 pc / 9 pc	63x63

Type: 16PK

SUPERSIZES (75/90 mm) **p. 64**



Reducing coupling
Verloopstuk
Réduction
Kupplung-reduziert

Article number	Bag / Box	Type
16PK-1614	10 pc / 100 pc	16x14
16PK-1814	10 pc / 100 pc	18x14
16PK-1816	10 pc / 100 pc	18x16
16PK-2014	10 pc / 100 pc	20x14
16PK-2016	10 pc / 100 pc	20x16
16PK-2018	10 pc / 100 pc	20x18
16PK-2616	5 pc / 60 pc	26x16
16PK-2618	5 pc / 50 pc	26x18
16PK-2620	5 pc / 50 pc	26x20
16PK-3216	5 pc / 50 pc	32x16
16PK-3220	5 pc / 40 pc	32x20
16PK-3226	5 pc / 40 pc	32x26
16PK-4026	5 pc / 30 pc	40x26
16PK-4032	5 pc / 25 pc	40x32
16PK-5032	1 pc / 15 pc	50x32
16PK-5040	1 pc / 15 pc	50x40
16PK-6340	1 pc / 8 pc	63x40
16PK-6350	1 pc / 8 pc	63x50



Did you know...

you could use the **PK-tool wrench** for PK and SK fittings to realise an even quicker installation of threaded Henco fittings.

Find more information on **p. 175**



Type: 17PK (CW617N) 

SUPERSIZES (75 mm) p. 64



Straight male adapter
Puntstuk
Raccord droit mâle
Übergangsfitting AG

Article number	Bag / Box	Type
17PK-1404	10 pc / 80 pc	14x1/2"
17PK-1604	10 pc / 80 pc	16x1/2"
17PK-1804	10 pc / 80 pc	18x1/2"
17PK-1805*	10 pc / 50 pc	18x3/4"
17PK-2004	10 pc / 80 pc	20x1/2"
17PK-2005	10 pc / 50 pc	20x3/4"
17PK-2605	10 pc / 50 pc	26x3/4"
17PK-2606	10 pc / 40 pc	26x1"
17PK-3206	10 pc / 40 pc	32x1"
17PK-3207	5 pc / 25 pc	32x5/4"
17PK-4006	5 pc / 25 pc	40x1"
17PK-4007	5 pc / 25 pc	40x5/4"
17PK-5008	1 pc / 10 pc	50x6/4"
17PK-6310	1 pc / 6 pc	63x2"

**TILL EXHAUSTION OF STOCK*

SUPERSIZES (75 mm) p. 65

Type: 17PK-N (CW602N) 



Straight male adapter
Puntstuk
Raccord droit mâle
Übergangsfitting AG

Article number	Bag / Box	Type
17PK-4006-N	5 pc / 25 pc	40x1"
17PK-4007-N	5 pc / 25 pc	40x5/4"
17PK-5008-N	1 pc / 10 pc	50x6/4"
17PK-6310-N	1 pc / 6 pc	63x2"

Type: 18PK (CW617N) 

SUPERSIZES (75 mm) p. 65



Straight female adapter
Schroefbus
Raccord droit femelle
Übergangsfitting IG

Article number	Bag / Box	Type
18PK-1404	10 pc / 80 pc	14x1/2"
18PK-1604	10 pc / 80 pc	16x1/2"
18PK-1804	10 pc / 80 pc	18x1/2"
18PK-1805	10 pc / 50 pc	18x3/4"
18PK-2004	10 pc / 80 pc	20x1/2"
18PK-2005	10 pc / 50 pc	20x3/4"
18PK-2605	10 pc / 50 pc	26x3/4"
18PK-2606	10 pc / 40 pc	26x1"
18PK-3206	10 pc / 40 pc	32x1"
18PK-3207	5 pc / 25 pc	32x5/4"
18PK-4006	5 pc / 25 pc	40x1"
18PK-4007	5 pc / 25 pc	40x5/4"
18PK-5008	1 pc / 10 pc	50x6/4"
18PK-6310	1 pc / 6 pc	63x2"



Henco Press

Henco Press Black

SUPERSIZES (75/90 mm) **p. 65**

1 Type: 18PK-N (CW602N)

2



Straight female adapter
Schroefbus
Raccord droit femelle
Übergangsfitting IG

Article number	Bag / Box	Type
18PK-4006-N	5 pc / 25 pc	40x1"
18PK-4007-N	5 pc / 25 pc	40x5/4"
18PK-5008-N	1 pc / 10 pc	50x6/4"
18PK-6310-N	1 pc / 6 pc	63x2"

7 Type: 18PK-X (INOX 316 L)

8



Straight female adapter INOX
Schroefbus INOX
Raccord droit femelle INOX
Übergangsfitting IG INOX

Article number	Bag / Box	Type
18PK-1404-X	10 pc / 80 pc	14x1/2"
18PK-1604-X	10 pc / 80 pc	16x1/2"
18PK-1804-X	10 pc / 80 pc	18x1/2"
18PK-1805-X	10 pc / 50 pc	18x3/4"
18PK-2004-X	10 pc / 80 pc	20x1/2"
18PK-2005-X	10 pc / 50 pc	20x3/4"
18PK-2605-X	10 pc / 50 pc	26x3/4"
18PK-2606-X	10 pc / 40 pc	26x1"
18PK-3206-X	10 pc / 40 pc	32x1"
18PK-3207-X	5 pc / 25 pc	32x5/4"
18PK-4006-X	5 pc / 25 pc	40x1"
18PK-4007-X	5 pc / 25 pc	40x5/4"
18PK-5008-X	1 pc / 10 pc	50x6/4"
18PK-6310-X	1 pc / 6 pc	63x2"

Type: 19PK



Press fit with swivel to eurocone
Perskoppeling met wartel en euroconus aansluiting
Raccord à sertir avec écrou à visser eurocone
Pressfitting mit Drehbar und Eurokonus

Article number	Bag / Box	Type
19PK-1605	10 pc / 80 pc	16x3/4" EK
19PK-2005	10 pc / 80 pc	20x3/4" EK



Did you know...

You can easily tighten the cable gland using the EK05-TOOL.

Find more information on **p. 173**





Type: 26PK (CW617N)



Press fitting with swivel and flat sealing
 Perskoppeling met wartel en vlakke dichting
 Raccord avec écrou libre / joint plat
 Pressfitting mit Drehbar und flach Versiegelung

Article number	Bag / Box	Type
26PK-1605	10 pc / 80 pc	16x3/4
26PK-2005	10 pc / 80 pc	20x3/4

Type: 26PK (CW617N)



Press fitting with swivel and flat sealing
 Perskoppeling met wartel en vlakke dichting
 Raccord avec écrou libre / joint plat
 Pressfitting mit Drehbar und flach Versiegelung

Article number	Bag / Box	Type
26PK-4007	5 pc / 15 pc	40x5/4"
26PK-4008	5 pc / 15 pc	40x6/4"
26PK-5008	1 pc / 10 pc	50x6/4"
26PK-5010	1 pc / 10 pc	50x2"
26PK-6310	1 pc / 6 pc	63x2"
26PK-6312	1 pc / 6 pc	63x2 1/2"

Type: 27PK

SUPERSIZES (75/90 mm) p. 65



Elbow 45°
 Knie 45°
 Coude 45°
 Winkel 45°

Article number	Bag / Box	Type
27PK-2626	5 pc / 50 pc	26x26
27PK-3232	5 pc / 30 pc	32x32
27PK-4040	5 pc / 25 pc	40x40
27PK-5050	1 pc / 10 pc	50x50
27PK-6363	1 pc / 5 pc	63x63

Type: 28PK-04



Bracket wallplate for 2PK, 6PK and 13PK, interaxis 153 mm
 Muurplaatbeugel voor 2PK, 6PK en 13PK, interaxis 153 mm
 Attache culasse pour 2PK, 6PK et 13PK, entraxe 153 mm
 Bügel Wandscheibe für 2PK, 6PK und 13PK, Mitte-zu-Mitte-Abstand 153 mm

Article number	Bag / Box	Type
28PK-04	1 pc / 50 pc	1/2" PK Backplate

Type: 53PK



Easy mounting fitting
 Eenvoudige montage fitting
 Raccord montage facile
 Einfache Montage Fitting

Article number	Bag / Box	Type
53PK40	1 pc / 20 pc	40x40
53PK50	1 pc / 9 pc	50x50
53PK63	1 pc / 6 pc	63x63



Henco Press

Henco Press White

Type: 1PKW



Elbow 90°
Knie 90°
Coude 90°
Winkel 90°

Article number	Bag / Box	Type
1PKW-1616	10 pc / 120 pc	16x16
1PKW-2020	10 pc / 80 pc	20x20
1PKW-2626	5 pc / 50 pc	26x26
1PKW-3232	5 pc / 30 pc	32x32

Type: 2PKW (CW617N)



Backplate elbow female
Sanitair muurplaat binnendraad
Culasse pour sanitaire
Sanitär Wandscheibe IG

Article number	Bag / Box	Type
2PKW-1604	10 pc / 50 pc	16x1/2" (56 mm)
2PKW-2004	10 pc / 50 pc	20x1/2" (56 mm)
2PKW-2005	5 pc / 30 pc	20x3/4" (61 mm)
2PKW-2605	5 pc / 30 pc	26x3/4" (66 mm)

Type: 2PKW-N (CW602N)



Backplate elbow female
Sanitair muurplaat binnendraad
Culasse pour sanitaire
Sanitär Wandscheibe IG

Article number	Bag / Box	Type
2PKW-1604-N*	10 pc / 50 pc	16x1/2" (56 mm)
2PKW-2004-N	10 pc / 50 pc	20x1/2" (56 mm)
2PKW-2005-N*	5 pc / 30 pc	20x3/4" (61 mm)
2PKW-2605-N	5 pc / 30 pc	26x3/4" (66 mm)

*TILL EXHAUSTION OF STOCK



Did you know...

you could use our **galvanised bracket plates** for the 2PKW, 2PKW-N, 2PKW-X, 2PKW-K, 2PKW-K-N and 2PKW-K-N fittings?

Find more information on **p. 179**



Type: 2PKW-X (INOX 316 L)

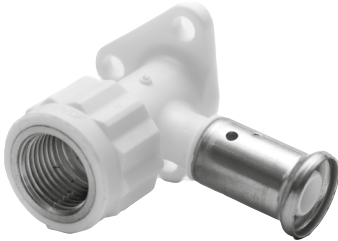

Backplate elbow female INOX
Sanitair muurplaat binnendraad INOX
Culasse pour sanitaire INOX
Sanitär Wandscheibe IG INOX

Article number	Bag / Box	Type
2PKW-1604-X	10 pc / 50 pc	16x1/2" (56 mm)
2PKW-2004-X	10 pc / 50 pc	20x1/2" (56 mm)
2PKW-2005-X	5 pc / 30 pc	20x3/4" (61 mm)
2PKW-2605-X	5 pc / 30 pc	26x3/4" (66 mm)

Type: 2PKW-K (CW617N)



Backplate elbow female, short model
Sanitair muurplaat binnendraad, laag
Culasse pour sanitaire, modèle court
Sanitär Wandscheibe IG, kurzes Modell

Article number	Bag / Box	Type
2PKW-1604K	10 pc / 50 pc	16x1/2" (41 mm)

Type: 2PKW-K-N (CW602N)



Backplate elbow female, short model
Sanitair muurplaat binnendraad, laag,
Culasse pour sanitaire, modèle court
Sanitär Wandscheibe IG, kurzes Modell

Article number	Bag / Box	Type
2PKW-1604K-N	10 pc / 50 pc	16x1/2" (41 mm)

Type: 2PKW-K-X (INOX 316)



Backplate elbow female, short model INOX
Sanitair muurplaat binnendraad, laag INOX
Culasse pour sanitaire, modèle court INOX
Sanitär Wandscheibe IG, kurzes Modell INOX

Article number	Bag / Box	Type
2PKW-1604K-X	10 pc / 50 pc	16x1/2" (41 mm)

- 1
- 2
- 3
- 4
- 5
- 6
- 7
- 8
- 9
- 10
- 11
- 12
- 13
- 14



Henco Press

Henco Press White

1 Type: 3PKW (CW617N)



Double backplate elbow female, short model
Sanitair muurplaat binnendraad dubbel, laag
Coude double plaque arrière femelle, modèle court
Sanitär Wandscheibe doppelt IG, kurzes Modell

Article number	Bag / Box	Type
3PKW-160416	10 pc / 30 pc	16x1/2"x16 (43,5 mm)
3PKW-200420	10 pc / 30 pc	20x1/2"x20 (43,5 mm)

2 Type: 3PKW-N (CW602N)



Double backplate elbow female, short model
Sanitair muurplaat binnendraad dubbel, laag
Coude double plaque arrière femelle, modèle court
Sanitär Wandscheibe doppelt IG, kurzes Modell

Article number	Bag / Box	Type
3PKW-160416-N	10 pc / 30 pc	16x1/2"x16 (43,5 mm)
3PKW-200420-N	10 pc / 30 pc	20x1/2"x20 (43,5 mm)

3 Type: 5PKW (CW617N)



Elbow 90° male adapter
Knie 90° buitendraad
Coude 90° mâle
Winkel 90° AG

Article number	Bag / Box	Type
5PKW-1604	10 pc / 60 pc	16x1/2"
5PKW-2004	10 pc / 60 pc	20x1/2"
5PKW-2005	10 pc / 50 pc	20x3/4"
5PKW-2605	10 pc / 40 pc	26x3/4"
5PKW-3206	5 pc / 20 pc	32x1"

4 Type: 5PKW-N (CW602N)



Elbow 90° male adapter
Knie 90° buitendraad
Coude 90° mâle
Winkel 90° AG

Article number	Bag / Box	Type
5PKW-1604-N	10 pc / 60 pc	16x1/2"
5PKW-2004-N	10 pc / 60 pc	20x1/2"
5PKW-2005-N	10 pc / 50 pc	20x3/4"
5PKW-2605-N	10 pc / 40 pc	26x3/4"
5PKW-3206-N*	5 pc / 20 pc	32x1"

*TILL EXHAUSTION OF STOCK



Type: 6PKW (CW617N) 



Elbow 90° female adapter
Knie 90° binnendraad
Coude 90° femelle
Winkel 90° IG

Article number	Bag / Box	Type
6PKW-1603	10 pc / 60 pc	16x3/8
6PKW-1604	10 pc / 60 pc	16x1/2"
6PKW-2004	10 pc / 60 pc	20x1/2"
6PKW-2005	10 pc / 50 pc	20x3/4
6PKW-2605	10 pc / 50 pc	26x3/4
6PKW-3206	5 pc / 20 pc	32x1"

Type: 6PKW-N (CW602N) 



Elbow 90° female adapter
Knie 90° binnendraad
Coude 90° femelle
Winkel 90° IG

Article number	Bag / Box	Type
6PKW-1603-N*	10 pc / 60 pc	16x3/8"
6PKW-1604-N	10 pc / 60 pc	16x1/2"
6PKW-2004-N	10 pc / 60 pc	20x1/2"
6PKW-2005-N	10 pc / 50 pc	20x3/4"
6PKW-2605-N	10 pc / 50 pc	26x3/4"
6PKW-3206-N*	5 pc / 20 pc	32x1"

**TILL EXHAUSTION OF STOCK*

Type: 6PKW-X (INOX 316 L) 



Elbow 90° female adapter INOX
Knie 90° binnendraad INOX
Coude 90° femelle INOX
Winkel 90° IG INOX

Article number	Bag / Box	Type
6PKW-1604-X	10 pc / 60 pc	16x1/2"
6PKW-2004-X	10 pc / 60 pc	20x1/2"
6PKW-2005-X	10 pc / 50 pc	20x3/4"
6PKW-2605-X	10 pc / 50 pc	26x3/4"
6PKW-3206-X	5 pc / 20 pc	32x1"



Did you know...

you could use the **PK-tool wrench** for PK and SK fittings to realise an even quicker installation of threaded Henco fittings.

Find more information on **p. 175**





Henco Press

Henco Press White

Type: 9PKW

1

2

3

4

5

6



T-piece
T-stuk
Pièce en T
T-Stück

Article number	Bag / Box	Type
9PKW-161616	10 pc / 60 pc	16x16x16
9PKW-202020	10 pc / 50 pc	20x20x20
9PKW-262626	5 pc / 30 pc	26x26x26
9PKW-323232	5 pc / 15 pc	32x32x32

Type: 10PKW

8

9

10

11

12



T-reduced centre
T-verlopend
Pièce en T réduit
T-reduziert

Article number	Bag / Box	Type
10PKW-201620	10 pc / 50 pc	20x16x20
10PKW-261626	5 pc / 30 pc	26x16x26
10PKW-262026	5 pc / 30 pc	26x20x26
10PKW-321632	5 pc / 25 pc	32x16x32
10PKW-322032	5 pc / 25 pc	32x20x32
10PKW-322632	5 pc / 20 pc	32x26x32

Type: 11PKW

14



T-branch and line reduced
T-2x verlopend
T-2x réduit
T-2x reduziert

Article number	Bag / Box	Type
11PKW-201616	10 pc / 50 pc	20x16x16
11PKW-202016	10 pc / 50 pc	20x20x16
11PKW-261616	10 pc / 50 pc	26x16x16
11PKW-261620	5 pc / 30 pc	26x16x20
11PKW-262016	5 pc / 30 pc	26x20x16
11PKW-262020	5 pc / 30 pc	26x20x20
11PKW-262616	5 pc / 30 pc	26x26x16
11PKW-262620	5 pc / 30 pc	26x26x20
11PKW-322026	5 pc / 20 pc	32x20x26
11PKW-322626	5 pc / 20 pc	32x26x26

Type: 12PKW



T-enlarged branch
T-vergroot
T-agrandi
T-erweitert

Article number	Bag / Box	Type
12PKW-162016	10 pc / 50 pc	16x20x16
12PKW-202620	5 pc / 30 pc	20x26x20
12PKW-263226	5 pc / 20 pc	26x32x26



Type: 13PKW (CW617N) 



T-female centre
T-binnendraad
T-femelle
T-IG

Article number	Bag / Box	Type
13PKW-160416	10 pc / 50 pc	16x1/2"x16
13PKW-200420	10 pc / 50 pc	20x1/2"x20
13PKW-200520	10 pc / 30 pc	20x3/4"x20
13PKW-260426	5 pc / 30 pc	26x1/2"x26
13PKW-260526	5 pc / 30 pc	26x3/4"x26
13PKW-320532	5 pc / 15 pc	32x3/4"x32
13PKW-320632	5 pc / 10 pc	32x1"x32

Type: 13PKW-N (CW602N) 



T-female centre
T-binnendraad
T-femelle
T-IG

Article number	Bag / Box	Type
13PKW-160416-N	10 pc / 50 pc	16x1/2"x16
13PKW-200420-N	10 pc / 50 pc	20x1/2"x20
13PKW-200520-N	10 pc / 30 pc	20x3/4"x20
13PKW-260426-N	5 pc / 30 pc	26x1/2"x26
13PKW-260526-N	5 pc / 30 pc	26x3/4"x26
13PKW-320532-N*	5 pc / 15 pc	32x3/4"x32
13PKW-320632-N*	5 pc / 10 pc	32x1"x32

Type: 13PKW-X (INOX 316 L) 



T-female centre INOX
T-binnendraad INOX
T-femelle INOX
T-IG INOX

Article number	Bag / Box	Type
13PKW-160416-X	10 pc / 50 pc	16x1/2"x16
13PKW-200420-X	10 pc / 50 pc	20x1/2"x20
13PKW-200520-X	10 pc / 30 pc	20x3/4"x20
13PKW-260426-X	5 pc / 30 pc	26x1/2"x26
13PKW-260526-X	5 pc / 30 pc	26x3/4"x26
13PKW-320532-X	5 pc / 15 pc	32x3/4"x32
13PKW-320632-X	5 pc / 10 pc	32x1"x32

**TILL EXHAUSTION OF STOCK*

Type: 14PKW (CW617N) 



T-male centre
T-buitendraad
T-mâle
T-AG

Article number	Bag / Box	Type
14PKW-160416	10 pc / 50 pc	16x1/2"x16
14PKW-200420	10 pc / 40 pc	20x1/2"x20
14PKW-200520	10 pc / 30 pc	20x3/4"x20
14PKW-320532	5 pc / 15 pc	32x3/4"x32



Henco Press

Henco Press White

Type: 14PKW-N (CW602N)



T-male centre
T-buitendraad
T-mâle
T-AG

Article number	Bag / Box	Type
14PKW-160416-N	10 pc / 50 pc	16x1/2"x16
14PKW-200420-N	10 pc / 40 pc	20x1/2"x20
14PKW-200520-N*	10 pc / 30 pc	20x3/4"x20

*TILL EXHAUSTION OF STOCK

Type: 15PKW



Straight coupling
Perssok
Manchon
Kupplung

Article number	Bag / Box	Type
15PKW-1616	10 pc / 150 pc	16x16
15PKW-2020	10 pc / 80 pc	20x20
15PKW-2626	5 pc / 50 pc	26x26
15PKW-3232	5 pc / 30 pc	32x32

Type: 16PKW



Reducing coupling
Verloopstuk
Réduction
Kupplung-reduziert

Article number	Bag / Box	Type
16PKW-2016	10 pc / 100 pc	20x16
16PKW-2616	5 pc / 60 pc	26x16
16PKW-2620	5 pc / 50 pc	26x20
16PKW-3216	5 pc / 50 pc	32x16
16PKW-3220	5 pc / 40 pc	32x20
16PKW-3226	5 pc / 40 pc	32x26

Type: 17PKW (CW617N)



Straight male adapter
Puntstuk
Raccord droit mâle
Übergangsfitting AG

Article number	Bag / Box	Type
17PKW-1604	10 pc / 80 pc	16x1/2"
17PKW-2004	10 pc / 80 pc	20x1/2"
17PKW-2005	10 pc / 50 pc	20x3/4"
17PKW-2605	10 pc / 50 pc	26x3/4"
17PKW-2606	10 pc / 40 pc	26x1"
17PKW-3206	10 pc / 40 pc	32x1"
17PKW-3207	5 pc / 25 pc	32x5/4"



Type: 17PKW-N (CW602N) 



Straight male adapter
Puntstuk
Raccord droit mâle
Übergangsfitting AG

Article number	Bag / Box	Type
17PKW-1604-N	10 pc / 80 pc	16x1/2"
17PKW-2004-N	10 pc / 80 pc	20x1/2"
17PKW-2005-N	10 pc / 50 pc	20x3/4"
17PKW-2605-N	10 pc / 50 pc	26x3/4"
17PKW-2606-N	10 pc / 40 pc	26x1"
17PKW-3206-N	10 pc / 40 pc	32x1"
17PKW-3207-N	5 pc / 25 pc	32x5/4"

Type: 18PKW (CW617N) 



Straight female adapter
Schroefbus
Raccord droit femelle
Übergangsfitting IG

Article number	Bag / Box	Type
18PKW-1604	10 pc / 80 pc	16x1/2"
18PKW-2004	10 pc / 80 pc	20x1/2"
18PKW-2005	10 pc / 50 pc	20x3/4"
18PKW-2605	10 pc / 50 pc	26x3/4"
18PKW-2606	10 pc / 40 pc	26x1"
18PKW-3206	10 pc / 40 pc	32x1"
18PKW-3207	5 pc / 25 pc	32x5/4"

Type: 18PKW-N (CW602N) 



Straight female adapter
Schroefbus
Raccord droit femelle
Übergangsfitting IG

Article number	Bag / Box	Type
18PKW-1604-N	10 pc / 80 pc	16x1/2"
18PKW-2004-N	10 pc / 80 pc	20x1/2"
18PKW-2005-N	10 pc / 50 pc	20x3/4"
18PKW-2605-N	10 pc / 50 pc	26x3/4"
18PKW-2606-N	10 pc / 40 pc	26x1"
18PKW-3206-N	10 pc / 40 pc	32x1"
18PKW-3207-N	5 pc / 25 pc	32x5/4"



Did you know...

you could use the **PK-tool wrench** for PK and SK fittings to realise an even quicker installation of threaded Henco fittings.

Find more information on **p. 175**





Henco Press

Henco Press White

1 Type: 18PKW-X (INOX 316 L)



Straight female adapter INOX
Schroefbus INOX
Raccord droit femelle INOX
Übergangsfitting IG INOX

Article number	Bag / Box	Type
18PKW-1604-X	10 pc / 80 pc	16x1/2"
18PKW-2004-X	10 pc / 80 pc	20x1/2"
18PKW-2005-X	10 pc / 50 pc	20x3/4"
18PKW-2605-X	10 pc / 50 pc	26x3/4"
18PKW-2606-X	10 pc / 40 pc	26x1"
18PKW-3206-X	10 pc / 40 pc	32x1"
18PKW-3207-X	5 pc / 25 pc	32x5/4"

9 Type: 19PKW



Press fitting to eurocone
Perskoppeling met euroconus aansluiting
Raccord avec raccord à visser eurocone
Pressfitting mit Eurokonus

Article number	Bag / Box	Type
19PKW-1605	10 pc / 80 pc	16x3/4" EK
19PKW-2005	10 pc / 80 pc	20x3/4" EK

Type: 26PKW



Press fitting with flat sealing
Perskoppeling met vlakke dichting
Raccord avec etachéité plate
Pressfitting mit flach Versiegelung

Article number	Bag / Box	Type
26PKW-1605*	10 pc / 80 pc	16x3/4"
26PKW-2005	10 pc / 80 pc	20x3/4"

**TILL EXHAUSTION OF STOCK*

Type: 27PKW



Elbow 45°
Knie 45°
Coude 45°
Winkel 45°

Article number	Bag / Box	Type
27PKW-2626	5 pc / 50 pc	26x26
27PKW-3232	5 pc / 30 pc	32x32



Gas: only allowed in countries where a Henco gas testing + certificate is available! (see www.henco.be)

Gas: enkel toegelaten in landen waar er een Henco gas keur is + een certificaat voorhanden is! (zie www.henco.be)

Gaz: seulement permis dans des pays où le contrôle a eu lieu + certificat est disponible! (Consultez www.henco.be)

Gas: nur zugelassen in Länder wo Henco gas Prüfung geschehen ist + Zertifikat vorhanden ist! (Siehe www.henco.be)

Type: 1PKG



Elbow 90°
Knie 90°
Coude 90°
Winkel 90°

Article number	Bag / Box	Type
1PKG-1616	10 pc / 120 pc	16x16
1PKG-2020	10 pc / 80 pc	20x20
1PKG-2626	5 pc / 50 pc	26x26
1PKG-3232	5 pc / 30 pc	32x32

Type: 2PKG (CW617N)



Backplate elbow female
Muurplaat binnendraad
Culasse femelle
Wandscheibe IG

Article number	Bag / Box	Type
2PKG-1603*	10 pc / 50 pc	16x3/8"(56 mm)
2PKG-1604BP	10 pc / 50 pc	16x1/2"(56 mm)
2PKG-2004BP	10 pc / 50 pc	20x1/2"(56 mm)
2PKG-2005	5 pc / 30 pc	20x3/4"(61 mm)
2PKG-2605	5 pc / 30 pc	26x3/4"(66 mm)

**TILL EXHAUSTION OF STOCK*

Type: 2PKG-K (CW617N)



Backplate elbow female, short model
Muurplaat binnendraad, laag
Culasse femelle, modèle court
Wandscheibe IG, kurzes Modell

Article number	Bag / Box	Type
2PKG-1604KBP	10 pc / 50 pc	16x1/2" (41 mm)



Henco Press

Henco Press Gas

Type: 5PKG (CW617N)



Elbow 90° male adapter
Knie 90° buitendraad
Coude 90° mâle
Winkel 90° AG

Article number	Bag / Box	Type
5PKG-1604	10 pc / 60 pc	16x1/2"
5PKG-2004	10 pc / 60 pc	20x1/2"
5PKG-2005	10 pc / 50 pc	20x3/4"
5PKG-2605*	10 pc / 40 pc	26x3/4"
5PKG-3206	5 pc / 20 pc	32x1"
5PKG-4007*	5 pc / 15 pc	40x5/4"

**TILL EXHAUSTION OF STOCK*

Type: 6PKG (CW617N)



Elbow 90° female adapter
Knie 90° binnendraad
Coude 90° femelle
Winkel 90° IG

Article number	Bag / Box	Type
6PKG-1604BP	10 pc / 60 pc	16x1/2"
6PKG-2004BP	10 pc / 60 pc	20x1/2"
6PKG-2005	10 pc / 50 pc	20x3/4"
6PKG-2605	10 pc / 50 pc	26x3/4"
6PKG-3206	5 pc / 20 pc	32x1"

Type: 9PKG



T-piece
T-stuk
Pièce en T
T-Stück

Article number	Bag / Box	Type
9PKG-161616	10 pc / 60 pc	16x16x16
9PKG-202020	10 pc / 50 pc	20x20x20
9PKG-262626	5 pc / 30 pc	26x26x26
9PKG-323232	5 pc / 15 pc	32x32x32



Type: 10PKG



T-reduced centre
T-verlopend
Pièce en T réduit
T-reduziert

Article number	Bag / Box	Type
10PKG-201620	10 pc / 50 pc	20x16x20
10PKG-261626	5 pc / 30 pc	26x16x26
10PKG-262026	5 pc / 30 pc	26x20x26
10PKG-321632*	5 pc / 25 pc	32x16x32
10PKG-322032	5 pc / 25 pc	32x20x32
10PKG-322632	5 pc / 20 pc	32x26x32
10PKG-401640*	5 pc / 15 pc	40x16x40

**TILL EXHAUSTION OF STOCK*

Type: 11PKG



T-branch and line reduced
T-2x verlopend
Pièce en T 2x réduit
T-2x reduziert

Article number	Bag / Box	Type
11PKG-201616	10 pc / 50 pc	20x16x16
11PKG-202016	10 pc / 50 pc	20x20x16
11PKG-261620*	5 pc / 30 pc	26x16x20
11PKG-262016*	5 pc / 30 pc	26x20x16
11PKG-262020.	5 pc / 30 pc	26x20x20
11PKG-262616*	5 pc / 30 pc	26x26x16
11PKG-262620*	5 pc / 30 pc	26x26x20
11PKG-322026*	5 pc / 20 pc	32x20x26
11PKG-322626	5 pc / 20 pc	32x26x26
11PKG-402032*	5 pc / 15 pc	40x20x32
11PKG-402632*	5 pc / 15 pc	40x26x32
11PKG-404026*	5 pc / 15 pc	40x40x26

**TILL EXHAUSTION OF STOCK*

Type: 12PKG



T-enlarged branch
T-vergroot
Pièce en T agrandi
T-erweitert

Article number	Bag / Box	Type
12PKG-162016	10 pc / 50 pc	16x20x16
12PKG-202620	5 pc / 30 pc	20x26x20
12PKG-263226*	5 pc / 20 pc	26x32x26
12PKG-324032*	5 pc / 10 pc	32x40x32

**TILL EXHAUSTION OF STOCK*



Henco Press

Henco Press Gas

Type: 13PKG (CW617N)

1

2

3

4

5

6

7

8

9

10

11



T-female centre
T-binnendraad
Pièce en T femelle
T-IG

Article number	Bag / Box	Type
13PKG-160416BP	10 pc / 50 pc	16x1/2"x16
13PKG-200420BP	10 pc / 50 pc	20x1/2"x20
13PKG-200520	10 pc / 30 pc	20x3/4"x20
13PKG-260420BP*	5 pc / 30 pc	26x1/2"x20
13PKG-260426BP	5 pc / 30 pc	26x1/2"x26
13PKG-260526	5 pc / 30 pc	26x3/4"x26
13PKG-320532	5 pc / 15 pc	32x3/4"x32
13PKG-320632	5 pc / 10 pc	32x1"x32
13PKG-320732*	5 pc / 10 pc	32x5/4"x32

**TILL EXHAUSTION OF STOCK*

Type: 14PKG (CW617N)

12

13

14



T-male centre
T-buitendraad
Pièce en T mâle
T-AG

Article number	Bag / Box	Type
14PKG-160416	10 pc / 50 pc	16x1/2"x16
14PKG-200420	10 pc / 40 pc	20x1/2"x20
14PKG-260426	5 pc / 20 pc	26x1/2"x26
14PKG-260626	5 pc / 20 pc	26x1"x26
14PKG-320532	5 pc / 15 pc	32x3/4"x32

TILL EXHAUSTION OF STOCK

Type: 15PKG

Straight coupling
Perssok
Manchon
Kupplung



Article number	Bag / Box	Type
15PKG-1616	10 pc / 150 pc	16x16
15PKG-2020	10 pc / 80 pc	20x20
15PKG-2626	5 pc / 50 pc	26x26
15PKG-3232	5 pc / 30 pc	32x32



Type: 16PKG



Reducing coupling
Verloopstuk
Réduction
Kupplung-reduziert

Article number	Bag / Box	Type
16PKG-2016	10 pc / 100 pc	20x16
16PKG-2616	5 pc / 60 pc	26x16
16PKG-2620	5 pc / 50 pc	26x20
16PKG-3216*	5 pc / 50 pc	32x16
16PKG-3220	5 pc / 40 pc	32x20
16PKG-3226	5 pc / 40 pc	32x26

Type: 17PKG (CW617N)



Straight male adapter
Puntstuk
Raccord droit mâle
Übergangsfitting AG

Article number	Bag / Box	Type
17PKG-1604	10 pc / 80 pc	16x1/2"
17PKG-2004	10 pc / 80 pc	20x1/2"
17PKG-2005	10 pc / 50 pc	20x3/4"
17PKG-2605	10 pc / 50 pc	26x3/4"
17PKG-2606	10 pc / 40 pc	26x1"
17PKG-3206	10 pc / 40 pc	32x1"
17PKG-3207	5 pc / 25 pc	32x5/4"

**TILL EXHAUSTION OF STOCK*

Type: 18PKG (CW617N)



Straight female adapter
Schroefbus
Raccord droit femelle
Übergangsfitting IG

Article number	Bag / Box	Type
18PKG-1604	10 pc / 80 pc	16x1/2"
18PKG-2004	10 pc / 80 pc	20x1/2"
18PKG-2005	10 pc / 50 pc	20x3/4"
18PKG-2605	10 pc / 50 pc	26x3/4"
18PKG-2606	10 pc / 40 pc	26x1"
18PKG-3206	10 pc / 40 pc	32x1"
18PKG-3207	5 pc / 25 pc	32x5/4"
18PKG-4007*	5 pc / 25 pc	40x5/4"

**TILL EXHAUSTION OF STOCK*

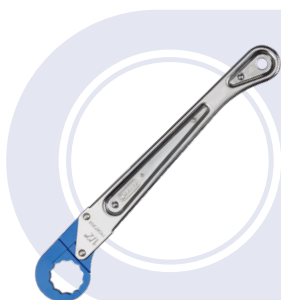

Did you know...

you could use the **PK-tool wrench** for PK and SK fittings to realise an even quicker installation of threaded Henco fittings.

Find more information on **p. 175**



Henco Press

Henco Press SUPER SIZES

Detailed overview of Super Sizes possibilities

1

2

3

4

5

6

7

8

9

10

11

12

13

14

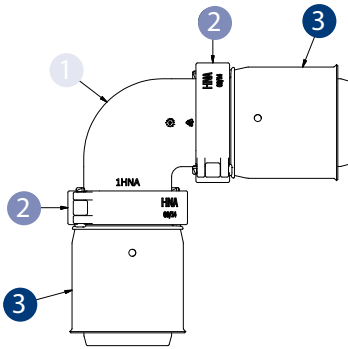

1PK

- 1 1HNA or 1HNB
- 2 HNA or HNB
- 3 8HNA-PK40 or 8HNA-PK50 or 8HNA-PK63 or 8HNA-PK75 or 8HNB-PK90

Example / Voorbeeld / Exemple / Beispiel

1PK-7575 = 1x 1HNA + 2xHNA + 2x 8HNA-PK75

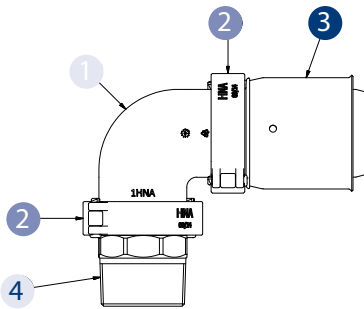

5PK / 6PK

- 1 1HNA or 1HNB
- 2 HNA or HNB
- 3 8HNA-PK75 or 8HNB-PK90
- 4 17HNA-10 or 17HNA-12 or 18HNA-06 or 18HNA-10 or 18HNA-12 or 18HNB-14

Example / Voorbeeld / Exemple / Beispiel

5PK-7510 = 1x 1HNA + 2xHNA + 1x 8HNA-PK75 + 1x17HNA-10

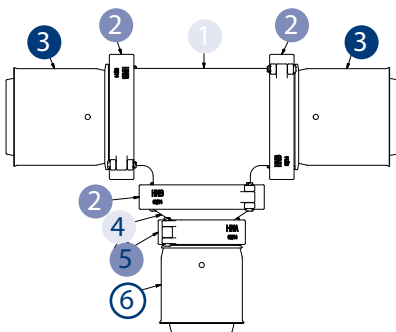

10PK / 11PK / 12PK (90mm)

- 1 9HNA
- 2 HNA
- 3 8HNB-PK90
- 4 16HNBA
- 5 HNA
- 6 8HNA-PK32 or 8HNA-PK40 or 8HNA-PK50 or 8HNA-PK63 or 8HNA-PK75

Example / Voorbeeld / Exemple / Beispiel

10PK-905090 = 1x 9HNB + 3x HNB + 2x 8HNB-PK90 + 1x 16HNBA + 1xHNA + 8HNA-PK50



- 1
- 2
- 3
- 4
- 5
- 6
- 7
- 8
- 9
- 10
- 11
- 12
- 13
- 14

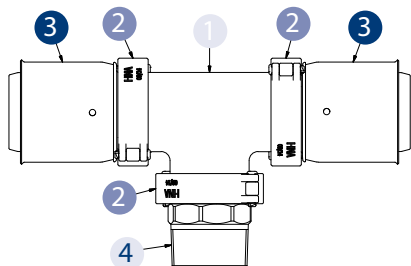

13PK / 14PK

- 1 9HNA or 9HNB
- 2 HNA or HNB
- 3 8HNA-PK75 or 8HNB-PK90
- 4 17HNA-10 or 17HNA-12 or 18HNA-06 or 18HNA-10 or 18HNA-12 or 18HNB-14

Example / Voorbeeld / Exemple / Beispiel

13PK-750675 = 1x 9HNA + 3x HNA + 8HNA-PK75 + 18HNA-06

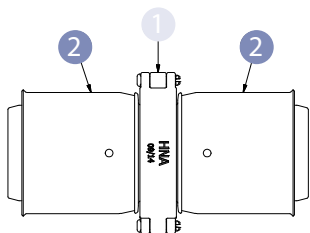

15PK / 16PK

- 1 HNA or HNB
- 2 8HNA-PK75 or 8HNB-PK90

Example / Voorbeeld / Exemple / Beispiel

15PK-7575 = 1x HNA + 2x 8HNA-PK75

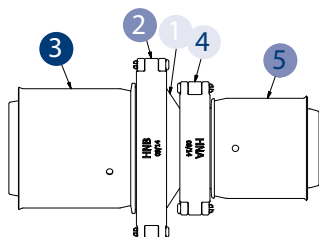

16PK

- 1 16HNBA
- 2 HNB
- 3 8HNB-PK90
- 4 HNA
- 5 8HNA-PK32 or 8HNA-PK40 or 8HNA-PK50 or 8HNA-PK63 or 8HNA-PK75

Example / Voorbeeld / Exemple / Beispiel

16PK-9063 = 1x 16HNBA + 1x HNB + 1x 8HNB-PK90 + 1x HNA + 1x 8HNA-PK63



Henco Press

Henco Press SUPER SIZES

- 1
- 2
- 3
- 4
- 5
- 6
- 7
- 8
- 9
- 10
- 11
- 12
- 13

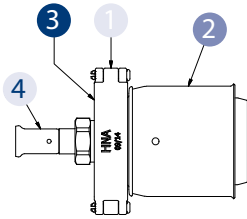

16PK-7516

- 1 HNA
- 2 8HNA-PK75
- 3 HNA-EK05
- 4 19P-1605 or 19P-1805 or 19P-2005 or 33P-1605 or 19SK-1605 or 19SK-2005

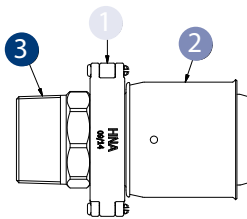

17PK / 18PK

- 1 HNA or HNB
- 2 8HNA-PK75 or 8HNB-PK90
- 3 17HNA or 18HNA or 18HNB

Example / Voorbeeld / Exemple / Beispiel

18PK-7512 = 1x HNA + 1x 8HNA-PK75 + 1x 18HNA-12

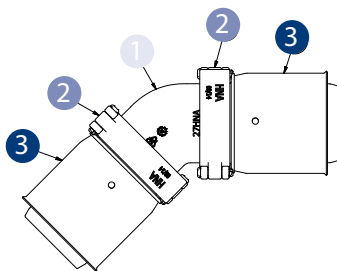

27PK

- 1 27HNA or 27HNB
- 2 HNA or HNB
- 3 8HNA-PK75 or 8HNB-PK90

Example / Voorbeeld / Exemple / Beispiel

27PK-9090 = 1x 27HNB + 2xHNB + 2x 8HNB-PK90



Super Size

Easy montage

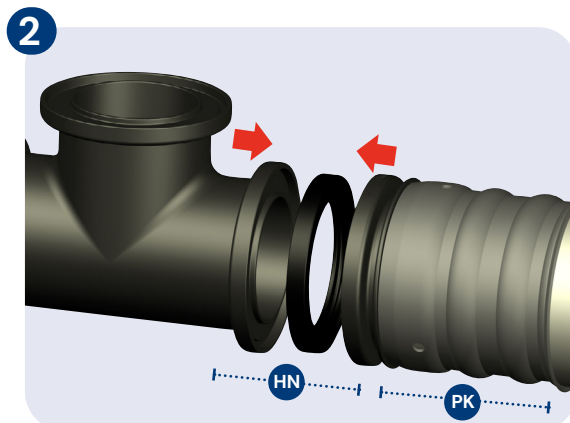
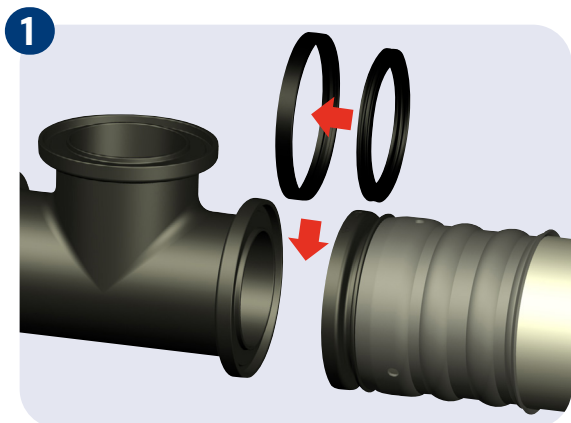

HN connection = click and lock
PK connection = press connection

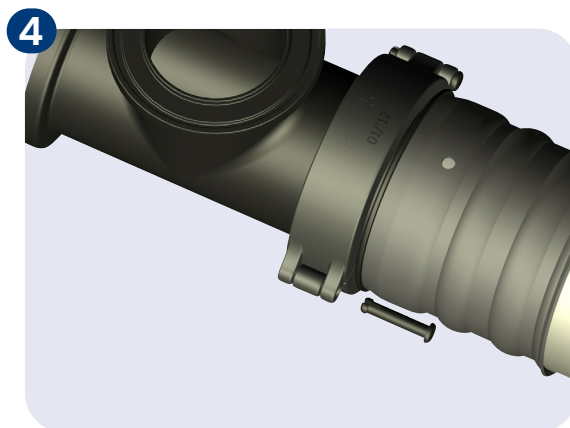
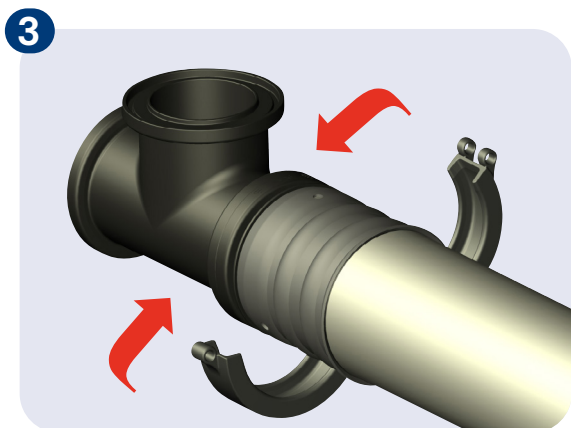

HNA: PK32 / PK40 / PK50 / PK63 / PK75
HNB: PK90

- 1
- 2
- 3
- 4
- 5
- 6
- 7
- 8
- 9
- 10
- 11
- 12
- 13



Henco Press

Henco Press SUPER SIZES

1 Type: 1HN

2



Elbow 90°
Knie 90°
Coude 90°
Winkel 90°

Article number	Box	Type
1HNA	1 pc	75x75
1HNB	1 pc	90x90

3

4 Type: 8HN

5



Press fitting
Perskoppeling
Raccord à sertir
Pressfitting

Article number	Bag / Box	Type
8HNB-PK90	1 pc / 4 pc	75x90
8HNA-PK40	1 pc / 20 pc	75x40
8HNA-PK50	1 pc / 12 pc	75x50
8HNA-PK63	1 pc / 12 pc	75x63
8HNA-PK75	1 pc / 12 pc	75x75
8HNA-PK32	1 pc / 20 pc	75x32

6

7

8

9

10

11

12

13

14

Type: 9HN



T-piece
T-stuk
Pièce en T
T-Stück

Article number	Box	Type
9HNA	1 pc / 7 pc	75x75x75
9HNB	1 pc	90x90x90

Type: 16HN



Reducing coupling
Verloopstuk
Pièce en T
Kupplung-reduziert

Article number	Bag / Box	Type
16HNBA	1 pc / 15 pc	90x75



Type: 17HN (CW617N)



Brass adapter male
Messing adapter buitendraad
Raccord en laiton mâle
Anschluss Bügel AG

Article number	Bag / Box	Type
17HNA-10	1 pc / 22 pc	75x2"
17HNA-12	1 pc / 18 pc	75x2 1/2"
17HNB-14	1 pc / 8 pc	90x3"

Type: 17HN-N (CW602N)



Brass adapter male
Messing adapter buitendraad
Raccord en laiton mâle
Anschluss Bügel AG

Article number	Bag / Box	Type
17HNA-10-N	1 pc / 22 pc	75x2"
17HNA-12-N	1 pc / 18 pc	75x2 1/2"

Type: 17HN-X (INOX 316L)



Adapter male INOX 316L
Adapter INOX 316L
Raccord mâle INOX 316L
Anschluss Bügel AG INOX 316L

Article number	Box	Type
17HNA-06-X	1 pc	75x1"
17HNA-07-X	1 pc	75x5/4"
17HNA-08-X	1 pc	75x6/4"
17HNA-10-X	1 pc	75x2"
17HNA-12-X	1 pc	75x2 1/2"

Type: 18HN (CW617N)



Brass adapter female
Messing adapter binnendraad
Raccord en laiton femelle
Anschluss Bügel IG

Article number	Bag / Box	Type
18HNA-06	1 pc / 40 pc	75x1"
18HNA-10	1 pc / 27 pc	75x2"
18HNA-12	1 pc / 16 pc	75x2 1/2"
18HNB-14	1 pc / 12 pc	90x3"

- 1
- 2
- 3
- 4
- 5
- 6
- 7
- 8
- 9
- 10
- 11
- 12
- 13
- 14



Henco Press

Henco Press SUPER SIZES

Type: 18HN-N (CW602N)



Brass adapter female
Messing adapter binnendraad
Raccord en laiton femelle
Anschluss Bügel IG

Article number	Bag / Box	Type
18HNA-06-N	1 pc / 40 pc	75x1"
18HNA-10-N	1 pc / 27 pc	75x2"
18HNA-12-N	1 pc / 16 pc	75x2 1/2"
18HNB-14-N*	1 pc / 12 pc	90x3"

**TILL EXHAUSTION OF STOCK*

Type: 18HN-X (INOX 316 L)



Adapter female INOX 316L
Adapter binnendraad INOX 316L
Raccord femelle INOX 316L
Anschluss Bügel IG INOX 316L

Article number	Box	Type
18HNA-06-X	1 pc	75x1"
18HNA-08-X	1 pc	75x6/4"
18HNA-10-X	1 pc	75x2"
18HNA-12-X	1 pc	75x2 1/2"
18HNB-14-X	1 pc	90x3"

Type: 27HN



Elbow 45°
Knie 45°
Coude 45°
Winkel 45°

Article number	Bag / Box	Type
27HNA	1 pc / 15 pc	75
27HNB	1 pc / 4 pc	90

Type: HN



Bracket set
Beugelset
Support
Bügelset

Article number	Box	Type
HNA	1 pc	75
HNB	1 pc	90



Type: HN-PEN



Locking pin
Beugelpin
Goupille de verrouillage
Sicherungsstift

Article number	Bag / Box	Type
HN-PEN	50 pc / 1000 pc	75/90

Type: HN-U



Sealing ring
Dichtingsring
Anneau d'étanchéité
Dichtungsring

Article number	Bag	Type
HNA-U	10 pc	75
HNB-U	10 pc	90

Type: HN-CR



Ring HN
Centerring beugel HN
Anneau HN
Mittelringhalterung HN

Article number	Bag	Type
HNA-CR	10 pc	

Type: HN-STOP (CW617N)



Stop end for SUPER SIZES range
Eindstop voor SUPER SIZES gamma
Bouchon d'arrêt SUPER SIZES
Endkappe für das Sortiment SUPER SIZES

Article number	Bag / Box	Type
HNA-STOP*	1 pc / 90 pc	75
HNB-STOP	1 pc / 40 pc	90

**TILL EXHAUSTION OF STOCK*

Type: HN-STOP-E (CW625N)



Stop end for SUPER SIZES range
Eindstop voor SUPER SIZES gamma
Bouchon d'arrêt SUPER SIZES
Endkappe für das Sortiment SUPER SIZES

Article number	Bag / Box	Type
HNA-STOP-E	1 pc / 50 pc	75



Henco Press

Henco Press SUPER SIZES

1 Type: HNA-INLB-E (CW625N)

2



Base plate for Ecoline solution
Basisplaat voor inliner
Plaque de base pour la solution Ecoline
Grundplatte für Inliner

Article number	Bag	Type
HNA-INLB-E	1 pc	16 x 3/4"

6 Type: HNA-EK05-E (CW625N)

7



Adapter HNA x EK 3/4"
Overgang HNA x EK 3/4"
Réduction HNA x EK 3/4"
Übergang HNA x EK 3/4"

Article number	Bag / Box	Type
HNA-EK05-E	1 pc / 50 pc	75 x 3/4" EK

11 Type: HN-COMP (INOX 316L)

12



HN expansion bellow
HN compensator
HN compensateur
HN Kompensator

Article number	Bag	Type
HNA-COMP	1 pc	HNA

Type: HN-FL (INOX 316L)



Flange connection
Flensaansluiting
Raccordement bride
Flanschverbindung

Article number	Box	Type
HNAFL-DN50	1 pc	HNxDN50

Type: HN-1



Elbow 90°
Knie 90°
Coude 90°
Winkel 90°

Article number	Box	Type
1PK-7575	1 pc	75x75
1PK-9090	1 pc	90x90



Type: HN-5 (CW617N)



Elbow 90° male adapter
Knie 90° buitendraad
Coude 90° mâle
Winkel 90° AG

Article number	Box	Type
5PK-7510	1 pc	75x2"
5PK-7512	1 pc	75x2 1/2"

Type: HN-5-N (CW602N)



Elbow 90° male adapter
Knie 90° buitendraad
Coude 90° mâle
Winkel 90° AG

Article number	Box	Type
5PK-7510-N	1 pc	75x2"
5PK-7512-N	1 pc	75x2 1/2"

Type: HN-6 (CW617N)



Elbow 90° female adapter
Knie 90° binnendraad
Coude 90° femelle
Winkel 90° IG

Article number	Box	Type
6PK-7506	1 pc	75x1"
6PK-7510	1 pc	75x2"
6PK-7512	1 pc	75x2 1/2"
6PK-9014	1 pc	90x3"

Type: HN-6-N (CW602N)



Elbow 90° female adapter
Knie 90° binnendraad
Coude 90° femelle
Winkel 90° IG

Article number	Box	Type
6PK-7506-N	1 pc	75x1"
6PK-7510-N	1 pc	75x2"
6PK-7512-N	1 pc	75x2 1/2"
6PK-9014-N	1 pc	90x3"

- 1
- 2
- 3
- 4
- 5
- 6
- 7
- 8
- 9
- 10
- 11
- 12
- 13
- 14



Henco Press

Henco Press SUPER SIZES

Type: HN-9



T-piece
T-stuk
Pièce en T
T-Stück

Article number	Box	Type
9PK-757575	1 pc	75x75x75
9PK-909090	1 pc	90x90x90

Type: HN-10



T-reduced centre
T-verlopend
Pièce en T réduit
T-reduziert

Article number	Box	Type
10PK-753275	1 pc	75x32x75
10PK-754075	1 pc	75x40x75
10PK-755075	1 pc	75x50x75
10PK-756375	1 pc	75x63x75
10PK-903290	1 pc	90x32x90
10PK-904090	1 pc	90x40x90
10PK-905090	1 pc	90x50x90
10PK-906390	1 pc	90x63x90
10PK-907590	1 pc	90x75x90

Type: HN-11



T-branch and line reduced
T-2x verlopend
Pièce en T 2x réduit
T-2x reduziert

Article number	Box	Type
11PK-753232	1 pc	75x32x32
11PK-753240	1 pc	75x32x40
11PK-753250	1 pc	75x32x50
11PK-753263	1 pc	75x32x63
11PK-754040	1 pc	75x40x40
11PK-754050	1 pc	75x40x50
11PK-754063	1 pc	75x40x63
11PK-755050	1 pc	75x50x50
11PK-755063	1 pc	75x50x63
11PK-756363	1 pc	75x63x63
11PK-903232	1 pc	90x32x32
11PK-903240	1 pc	90x32x40
11PK-903250	1 pc	90x32x50
11PK-903263	1 pc	90x32x63
11PK-903275	1 pc	90x32x75
11PK-904040	1 pc	90x40x40
11PK-904050	1 pc	90x40x50
11PK-904063	1 pc	90x40x63
11PK-904075	1 pc	90x40x75
11PK-905050	1 pc	90x50x50
11PK-905063	1 pc	90x50x63
11PK-905075	1 pc	90x50x75
11PK-906363	1 pc	90x63x63



Type: HN-11



T-branch and line reduced
T-2x verlopend
Pièce en T 2x réduit
T-2x reduziert

Article number	Box	Type
11PK-906375	1 pc	90x63x75
11PK-907575	1 pc	90x75x75

Type: HN-12



T-enlarged branch
T-vergroot
Pièce en T agrandi
T-erweitert

Article number	Box	Type
12PK-327532	1 pc	32x75x32
12PK-329032	1 pc	32x90x32
12PK-407540	1 pc	40x75x40
12PK-409040	1 pc	40x90x40
12PK-507550	1 pc	50x75x50
12PK-509050	1 pc	50x90x50
12PK-637563	1 pc	63x75x63
12PK-639063	1 pc	63x90x63
12PK-759075	1 pc	75x90x75

Type: HN-13



T-female centre
T-binnendraad
Pièce en T femelle
T-IG

Article number	Box	Type
13PK-750675	1 pc	75x1"x75
13PK-751075	1 pc	75x2"x75
13PK-751275	1 pc	75x2 1/2"x75
13PK-901490	1 pc	90x3"x90

Type: HN-13-N (CW602N)



T-female centre
T-binnendraad
Pièce en T femelle
T-IG

Article number	Box	Type
13PK-750675-N	1 pc	75x1"x75
13PK-751075-N	1 pc	75x2"x75
13PK-751275-N	1 pc	75x2 1/2"x75
13PK-901490-N	1 pc	90x3"x90

Type: HN-14 (CW617N)



T-male centre
T-buitendraad
Pièce en T mâle
T-AG

Article number	Box	Type
14PK-751075	1 pc	75x2"x75
14PK-751275	1 pc	75x2 1/2"x75



Henco Press

Henco Press SUPER SIZES

Type: HN-14-N (CW602N)

1

2

3

4

5

6

7



T-male centre
T-buitendraad
Pièce en T mâle
T-AG

Article number	Box	Type
14PK-751075-N	1 pc	75x2"x75
14PK-751275-N	1 pc	75x2 1/2"x75

Type: HN-15

8

9

10

11

12

13

14



Straight coupling
Perssok
Manchon
Kupplung

Article number	Box	Type
15PK-7575	1 pc	75x75
15PK-9090	1 pc	90x90

Type: HN-16



Reducing coupling
Verloopstuk
Réduction
Kupplung-reduziert

Article number	Box	Type
16PK-7532	1 pc	75x32
16PK-7540	1 pc	75x40
16PK-7550	1 pc	75x50
16PK-7563	1 pc	75x63
16PK-9032	1 pc	90x32
16PK-9040	1 pc	90x40
16PK-9050	1 pc	90x50
16PK-9063	1 pc	90x63
16PK-9075	1 pc	90x75

Type: HN-17 (CW617N)



Straight male adapter
Puntstuk
Raccord droit mâle
Übergangsfitting AG

Article number	Box	Type
17PK-7510	1 pc	75x2"
17PK-7512	1 pc	75x2 1/2"



Type: HN-17-N (CW602N)



Straight male adapter
Puntstuk
Raccord droit mâle
Übergangsfitting AG

Article number	Box	Type
17PK-7510-N	1 pc	75x2"
17PK-7512-N	1 pc	75x2 1/2"

Type: HN-18 (CW617N)



Straight female adapter
Schroefbus
Raccord droit femelle
Übergangsfitting IG

Article number	Box	Type
18PK-7506	1 pc	75x1"
18PK-7510	1 pc	75x2"
18PK-7512	1 pc	75x2 1/2"
18PK-9014	1 pc	90x3"

Type: HN-18-N (CW602N)



Straight female adapter
Schroefbus
Raccord droit femelle
Übergangsfitting IG

Article number	Box	Type
18PK-7506-N	1 pc	75x1"
18PK-7510-N	1 pc	75x2"
18PK-7512-N	1 pc	75x2 1/2"
18PK-9014-N	1 pc	90x3"

Type: HN-27



Elbow 45°
Knie 45°
Coude 45°
Winkel 45°

Article number	Box	Type
27PK-7575	1 pc	75x75
27PK-9090	1 pc	90x90

- 1
- 2
- 3
- 4
- 5
- 6
- 7
- 8
- 9
- 10
- 11
- 12
- 13
- 14



Henco Press

Henco Ecoline

Type: Ecoline-Set



Henco Ecoline Henco Ecoline-Set

Article number	Box	Type
HNA-ECOLINE-SET	1 pc	

Composition:



9HNA
T-piece



HNA-EK05-E
Adapter HNA-EK



HNA
Bracket set



HNA-INLB-E
Base plate for inliner

The Henco ECO-line is an energy saving solution for recirculation loops, which limits heat loss between supply and return pipe.

A separate pipe for the circulation water is no longer required. Designed on the Henco Super Size concept, it also combines modularity and easy installation.

One concept for all dimensions from 40 up to 75mm

- ✓ Cost effective
- ✓ Easy installation
- ✓ Less space consumption
- ✓ Anti legionellosis

Additional items to complete the ECOLINE installation

Article number	Description	Page
8HNA-PK...	Press fitting 40, 50, 63 or 75	56
50-MXC1620	Henco 1L PE-Xc 16x2 - 50m	20
19P-1605	Nickel plated press-fit adapter to eurocone 16x3/4"	84
19P-2005	Nickel plated press-fit adapter to eurocone 20x3/4"	84
33P-1605	Nickel plated press-fit adapter to eurocone 90° 16x3/4"	88
19PK-1605	Press fit swivel to eurocone 16x3/4"	36
19PK-2005	Press fit swivel to eurocone 20x3/4"	36
19SK-1605	Push fitting with eurocone connection 16x3/4"	113
19SK-2005	Push fitting with eurocone connection 20x3/4"	113



To complete the Ecoline installation you need to have a circulator and thermostatic balancing valve (not in Henco range).



Henco Vision – Push Fit

	<i>Page</i>
<i>Henco Vision Fittings</i>	68
<i>Manifolds</i>	74



Henco Vision - Push Fit

Henco Vision Fittings

1 Type: 1SK



Elbow 90°
Knie 90°
Coude 90°
Winkel 90°

Article number	Bag / Box	Type
1SK-1616	10 pc / 70 pc	16x16
1SK-2020	10 pc / 50 pc	20x20
1SK-2626	5 pc / 40 pc	26x26

4

5

6

7

8 Type: 2SK



Backplate elbow female
Sanitair muurplaat binnendraad
Culasse pour sanitaire femelle
Sanitär Wandscheibe IG

Article number	Bag / Box	Type
2SK-1604BP	10 pc / 40 pc	16x1/2" (55mm)
2SK-2004BP	10 pc / 40 pc	20x1/2" (59,5mm)
2SK-2005	10 pc / 30 pc	20x3/4" (61mm)
2SK-2605	5 pc / 20 pc	26x3/4" (65mm)

8

9

10

11

12

13

14

Type: 2S



Backplate elbow female, short model
Sanitair muurplaat binnendraad, laag
Culasse pour sanitaire femelle, modèle court
Sanitär Wandscheibe IG, kurzes Modell

Article number	Bag / Box	Type
2S-1604K	10 pc / 50 pc	16 x 1/2" (43mm)

Type: 3SK



Double backplate elbow female, short model
Dubbel sanitair muurplaat binnendraad, laag
Culasse double pour sanitaire, modèle court
Sanitär Wandscheibe doppelt IG, kurzes Modell

Article number	Bag / Box	Type
3SK-160416BP	10 pc / 30 pc	16x1/2"x16 (42mm)
3SK-200420BP	10 pc / 30 pc	20x1/2"x20 (47mm)



Type: 5SK



Elbow 90° male adapter
Knie 90° buitendraad
Coude 90° mâle
Winkel 90° AG

Article number	Bag / Box	Type
5SK-1604	10 pc / 60 pc	16x1/2"
5SK-2004	10 pc / 50 pc	20x1/2"
5SK-2005	10 pc / 40 pc	20x3/4"
5SK-2605	5 pc / 30 pc	26x3/4"

Type: 6SK



Elbow 90° female adapter
Knie 90° binnendraad
Coude 90° femelle
Winkel 90° IG

Article number	Bag / Box	Type
6SK-1604BP	10 pc / 60 pc	16x1/2"
6SK-2004BP	10 pc / 60 pc	20x1/2"
6SK-2005	10 pc / 30 pc	20x3/4"
6SK-2605	10 pc / 30 pc	26x3/4"

Type: 9SK



T-piece
T-stuk
Pièce en T
T-Stück

Article number	Bag / Box	Type
9SK-161616	10 pc / 40 pc	16x16x16
9SK-202020	10 pc / 30 pc	20x20x20
9SK-262626	5 pc / 20 pc	26x26x26

Type: 10SK



T-reduced centre
T-verlopend
Pièce en T réduit
T-reduziert

Article number	Bag / Box	Type
10SK-201620	10 pc / 40 pc	20x16x20
10SK-261626	5 pc / 25 pc	26x16x26
10SK-262026	5 pc / 20 pc	26x20x26



Did you know...

you could use the **PK-tool wrench** for PK and SK fittings to realise an even quicker installation of threaded Henco fittings.

Find more information on **p. 175**





Henco Vision - Push Fit

Henco Vision Fittings

Type: 11SK



T-branch and line reduced
T-2x verlopend
Pièce en T 2x réduit
T-2x reduziert

Article number	Bag / Box	Type
11SK-201616	10 pc / 40 pc	20x16x16
11SK-202016	10 pc / 30 pc	20x20x16
11SK-261620	5 pc / 25 pc	26x16x20
11SK-262016*	5 pc / 25 pc	26x20x16
11SK-262020	5 pc / 25 pc	26x20x20
11SK-262616	5 pc / 25 pc	26x26x16
11SK-262620	5 pc / 20 pc	26x26x20

**TILL EXHAUSTION OF STOCK*

Type: 12SK



T-enlarged branch
T-vergroot
Pièce en T agrandi
T-erweitert

Article number	Bag / Box	Type
12SK-162016	10 pc / 40 pc	16x20x16
12SK-202620	5 pc / 30 pc	20x26x20

Type: 13SK



T-female centre
T-binnendraad
Pièce en T femelle
T-IG

Article number	Bag / Box	Type
13SK-160416BP	10 pc / 40 pc	16x1/2"x16
13SK-200420BP	10 pc / 30 pc	20x1/2"x20
13SK-200520	10 pc / 30 pc	20x3/4"x20
13SK-260420BP	5 pc / 20 pc	26x1/2"x20
13SK-260426BP	5 pc / 20 pc	26x1/2"x26
13SK-260526	5 pc / 20 pc	26x3/4"x26

Type: 14SK



T-male centre
T-buitendraad
Pièce en T mâle
T-AG

Article number	Bag / Box	Type
14SK-160416	10 pc / 40 pc	16x1/2"x16
14SK-200420	10 pc / 30 pc	20x1/2"x20
14SK-260426	5 pc / 20 pc	26x1/2"x26



Type: 15SK



Straight coupling
Perssok
Manchon
Kupplung

Article number	Bag / Box	Type
15SK-1616	10 pc / 70 pc	16x16
15SK-2020	10 pc / 60 pc	20x20
15SK-2626	5 pc / 30 pc	26x26

Type: 16SK



Reducing coupling
Verloopstuk
Réduction
Kupplung-reduziert

Article number	Bag / Box	Type
16SK-2016	10 pc / 80 pc	20x16
16SK-2616	10 pc / 50 pc	26x16
16SK-2620	10 pc / 40 pc	26x20

Type: 17SK



Straight male adapter
Puntstuk
Raccord droit mâle
Übergangsfitting AG

Article number	Bag / Box	Type
17SK-1603	10 pc / 80 pc	16x3/8"
17SK-1604	10 pc / 80 pc	16x1/2"
17SK-2004	10 pc / 60 pc	20x1/2"
17SK-2005	10 pc / 60 pc	20x3/4"
17SK-2605	10 pc / 40 pc	26x3/4"
17SK-2606	10 pc / 40 pc	26x1"

Type: 18SK



Straight female adapter
Schroefbus
Raccord droit femelle
Übergangsfitting IG

Article number	Bag / Box	Type
18SK-1604	10 pc / 80 pc	16x1/2"
18SK-2004	10 pc / 80 pc	20x1/2"
18SK-2005	10 pc / 60 pc	20x3/4"
18SK-2605	10 pc / 50 pc	26x3/4"
18SK-2606	10 pc / 40 pc	26x1"



Henco Vision - Push Fit

Henco Vision Fittings

Type: 17SKS (CW617N)



Straight nipple male
Puntstuk
Raccord droit mâle
Übergangsfitting AG

Article number	Bag / Box	Type
17SKS-2004	5 pc / 150 pc	20x1/2"
17SKS-2005	5 pc / 150 pc	20x3/4"
17SKS-2604	5 pc / 100 pc	26x1/2"
17SKS-2605	5 pc / 100 pc	26x3/4"

Applicable with HENCO Vision fittings & Full Flow Manifold

Type: 18SKS (CW617N)



Straight nipple female
Recht aansluitstuk binnendraad
Raccord droit femelle
Übergangsfitting IG

Article number	Bag / Box	Type
18SKS-2004	5 pc / 150 pc	20x1/2"
18SKS-2005	5 pc / 100 pc	20x3/4"
18SKS-2604	5 pc / 100 pc	26x1/2"
18SKS-2605	5 pc / 80 pc	26x3/4"

Applicable with HENCO Vision fittings & Full Flow Manifold

Type: 19SK



Push fitting with eurocone connection
Steekkoppeling met euroconus-aansluiting
Raccord push fit avec eurocone
Steckkupplung mit Eurokonus

Article number	Bag / Box	Type
19SK-1505	10 pc / 80 pc	15x3/4" EK
19SK-1605	10 pc / 80 pc	16x3/4" EK
19SK-2005	10 pc / 80 pc	20x3/4" EK

Not suited for embedding in floors and walls

Type: 26SK



Push fitting with swivel and flat sealing
Steekkoppeling met wartel en vlakke dichting
Raccord push fit avec raccord écrou étanchéité plate
Steckkupplung mit Drehbar und flach Versiegelung

Article number	Bag / Box	Type
26SK-1605	10 pc / 80 pc	16x3/4
26SK-2005	10 pc / 80 pc	20x3/4

TILL EXHAUSTION OF STOCK



Type: SK-PIESTOP



Stop end for pipe
Eindstop voor buis
Bouchon pour tube
Endkappe für Rohre

Article number	Bag / Box	Type
SK-PIESTOP16	10 pc / 120 pc	16
SK-PIESTOP20	10 pc / 80 pc	20
SK-PIESTOP26	10 pc / 80 pc	26

Type: SK-STOPCLIP



Reusable stop and clip for push fit connection
Herbruikbare stop en clip passend in een steekkoppeling
Bouchon et clip réutilisables pour connection push fit
Stopfen und clip für Steckanschluss, wieder verwendbar

Article number	Bag / Box	Type
SK-STOPCLIP16	10 pc / 120 pc	16
SK-STOPCLIP20	10 pc / 100 pc	20
SK-STOPCLIP26	10 pc / 80 pc	26

Type: VISION SET



Vision revision set
Vision revisie set
Set de révision Vision
Vision Entriegelungsschlüssel

Article number	Bag / Box	Type
VISION SET 16	1 pc / 200 pc	16
VISION SET 20	1 pc / 90 pc	20
VISION SET 26	1 pc / 80 pc	26

Type: VISION KEY



Vision disassembly key
Vision demontage sleutel
Clé de démontage Vision
Vision Entriegelungsschlüssel

Article number	Bag / Box	Type
VISION-KEY16	1 pc / 200 pc	16
VISION-KEY20	1 pc / 100 pc	20
VISION-KEY26	1 pc / 100 pc	26



Henco Vision - Push Fit

Manifolds

Type: SK-B05

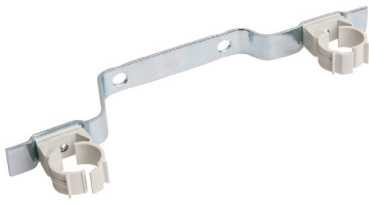

Bracket for manifolds
Montagebeugel voor verdelers
Double support pour collecteurs
Halter für Verteiler

Article number	Bag / Box	Type
SK-B05	1 pc / 25 pc	B05

Type: VSK



Extension or body for manifold, SK connections Ø16
Verlengstuk of basis voor verdeler, SK-aansluitingen Ø16
Complément ou base collecteur, sorties SK Ø16
Erweiterung oder Basiskörper für Verteiler, SK-Anschlüssen Ø16

Article number	Bag / Box	Type
VSK-1616	1 pc / 14 pc	16x16
VSK-161616	1 pc / 14 pc	16x16x16

More information...

See chapter **7A** for more options for the **Full Flow Manifold**

Find more information on **p. 113**



4



Henco Pro-Fit

Henco Pro-Fit

Page

76



Henco Pro-Fit

Henco Pro-Fit



Type: 53HPK



Telescopic fitting push-fit
 Telescopische fitting push-fit
 Raccord télescopique push-fit
 Teleskopverschraubung steckverbindung

Article number	Bag / Box	Type
53HPK-16	5 pc / 50 pc	16x16
53HPK-20	5 pc / 40 pc	20x20

Type: HPK-BK



Henco Pro-Fit protective cap, prevents seepage of concrete
 Henco Pro-Fit beschermkapje, voorkomt insijpelen van beton
 Henco Pro-Fit capuchon de protection, empêche l'infiltration de béton
 Henco Pro-Fit Schutzkappe, verhindert das Eindringen von Beton

Article number	Bag / Box	Type
HPK-BK16	10 pc / 240 pc	Ø16
HPK-BK20	10 pc / 240 pc	Ø20



Henco Brass Press

	<i>Page</i>
<i>Henco Brass Press Fittings</i>	<i>78</i>
<i>Henco Brass Press Fittings Gas</i>	<i>95</i>



Henco Brass Press

Henco Brass Press Fittings

Type: 1P



Elbow 90°
Knie 90°
Coude 90°
Winkel 90°

Article number	Bag / Box	Type
1P-1616	10 pc / 150 pc	16x16
1P-2020	10 pc / 80 pc	20x20
1P-2626	5 pc / 50 pc	26x26
1P-3232	5 pc / 30 pc	32x32

Type: 2P



Backplate elbow female
Sanitair muurplaat binnendraad
Culasse pour sanitaire femelle
Sanitär Wandscheibe IG

Article number	Bag / Box	Type
2P-1604	10 pc / 50 pc	16x1/2" (52 mm)
2P-1804	10 pc / 50 pc	18x1/2" (52 mm)
2P-2004	10 pc / 50 pc	20x1/2" (52 mm)
2P-2005	10 pc / 50 pc	20x3/4" (46 mm)
2P-2605	5 pc / 40 pc	26x3/4" (46 mm)

Type: 2P-K

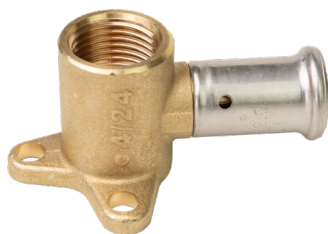

Backplate elbow female, short model
Sanitair muurplaat binnendraad, laag
Culasse double pour sanitaire, modèle court
Sanitär Wandscheibe IG, kurzes Modell

Article number	Bag / Box	Type
2P-1404K	10 pc / 50 pc	14x1/2" (35 mm)
2P-1604K	10 pc / 50 pc	16x1/2" (35 mm)

Type: 3P



Double backplate elbow female
Sanitair muurplaat binnendraad dubbel
Culasse double pour sanitaire
Sanitär Wandscheibe doppelt IG

Article number	Bag / Box	Type
3P-160416	10 pc / 40 pc	16x1/2"x16 (52 mm)
3P-200420	10 pc / 40 pc	20x1/2" x20 (52 mm)

TILL EXHAUSTION OF STOCK



Did you know...

you could use our **galvanised bracket plates** for the 2P, 2P-K, 3P-VK and 4P?

Find more information on **p. 179**



Type: 3P-VK



Double backplate elbow female (flow), short model
Doorstroom muurplaat binnendraad, laag
Culasse double femelle (écoulement), modèle court
Wandscheibe doppelt IG (Fluss), kurzes Modell

Article number	Bag / Box	Type
3P-200420VK*	5 pc / 20 pc	20x1/2"x20 (40 mm)
3P-260426VK	5 pc / 20 pc	26x1/2"x26 (40 mm)

**TILL EXHAUSTION OF STOCK*

Type: 3P-VK-U



Double backplate elbow female (flow), short model U-shape
Doorstroom muurplaat binnendraad, laag model U-vorm
Culasse double femelle (écoulement), modèle court U-form
Wandscheibe doppelt IG (Fluss), kurzes Modell U-form

Article number	Bag / Box	Type
3P-160416VK-U	5 pc / 20 pc	16x1/2"x16 (40 mm)
3P-200420VK-U	5 pc / 20 pc	20x1/2"x20 (40 mm)

Type: 4P



Backplate elbow female, extended model
Sanitair muurplaat binnendraad, hoog
Culasse pour sanitaire femelle, modèle long
Sanitär Wandscheibe IG, langes Modell

Article number	Bag / Box	Type
4P-1604	10 pc / 40 pc	16x1/2" (78 mm)
4P-2004	10 pc / 40 pc	20x1/2" (78 mm)

Type: 4P-K



Backplate elbow female, extended model
Sanitair muurplaat binnendraad, hoog
Culasse pour sanitaire femelle, modèle long
Sanitär Wandscheibe IG, langes Modell

Article number	Bag / Box	Type
4P-1604-K	10 pc / 40 pc	16x1/2" (71 mm)

Type: 5P



Elbow 90° male adapter
Knie 90° buitendraad
Coude 90° mâle
Winkel 90° AG

Article number	Bag / Box	Type
5P-1603	10 pc / 150 pc	16x3/8"
5P-1604	10 pc / 150 pc	16x1/2"
5P-2004	10 pc / 100 pc	20x1/2"
5P-2005	10 pc / 80 pc	20x3/4"
5P-2605	10 pc / 60 pc	26x3/4"
5P-2606	10 pc / 40 pc	26x1"
5P-3206	5 pc / 25 pc	32x1"



Henco Brass Press

Henco Brass Press Fittings

Type: 5P-DZR (CW602N)



Elbow 90° male adapter
Knie 90° buitendraad
Coude 90° mâle
Winkel 90° AG

Article number	Bag / Box	Type
5P-1603DZR	10 pc / 150 pc	16x3/8"
5P-1604DZR	10 pc / 150 pc	16x1/2"

Type: 6P



Elbow 90° female adapter
Knie 90° binnendraad
Coude 90° femelle
Winkel 90° IG

Article number	Bag / Box	Type
6P-1604	10 pc / 120 pc	16x1/2"
6P-1804	10 pc / 120 pc	18x1/2"
6P-2004	10 pc / 120 pc	20x1/2"
6P-2005	10 pc / 50 pc	20x3/4"
6P-2605	5 pc / 50 pc	26x3/4"

Type: 7P



Backplate elbow male
Sanitair muurplaat buitendraad met binnendraad 1/2"
Culasse pour sanitaire male
Sanitär Wandscheibe AG

Article number	Bag / Box	Type
7P-1605	5 pc / 30 pc	16x3/4" (78 mm)
7P-1605K*	5 pc / 30 pc	16x3/4" (60 mm)
7P-1605L	5 pc / 30 pc	16x3/4" (70 mm)

**TILL EXHAUSTION OF STOCK*

Type: 8P



Sanitary adapter female
Sanitair aansluitstuk met binnendraad
Culasse pour sanitaire femelle
UP-Spülkastenwinkel

Article number	Bag / Box	Type
8P-1604	10 pc / 50 pc	16x1/2"



Type: 9P



T-piece
T-stuk
Pièce en T
T-Stück

Article number	Bag / Box	Type
9P-161616	10 pc / 60 pc	16x16x16
9P-181818*	10 pc / 60 pc	18x18x18
9P-202020	10 pc / 50 pc	20x20x20
9P-262626	5 pc / 30 pc	26x26x26

**TILL EXHAUSTION OF STOCK*

Type: 10P



T-reduced centre
T-verlopend
Pièce en T-réduit
T-reduziert

Article number	Bag / Box	Type
10P-201620	10 pc / 50 pc	20x16x20
10P-261626	5 pc / 30 pc	26x16x26
10P-262026	5 pc / 30 pc	26x20x26

Type: 11P



T-branch and line reduced
T-2x verlopend
Pièce en T 2x réduit
T-2x reduziert

Article number	Bag / Box	Type
11P-201616	10 pc / 50 pc	20x16x16
11P-202016	10 pc / 50 pc	20x20x16
11P-261620	5 pc / 30 pc	26x16x20
11P-262020	5 pc / 30 pc	26x20x20
11P-262616	5 pc / 30 pc	26x26x16
11P-262620	5 pc / 30 pc	26x26x20
11P-322626*	5 pc / 20 pc	32x26x26

**TILL EXHAUSTION OF STOCK*

Type: 12P



T-enlarged branch
T-vergroot
Pièce en T agrandi
T-erweitert

Article number	Bag / Box	Type
12P-162016	10 pc / 60 pc	16x20x16
12P-202620	5 pc / 30 pc	20x26x20



Henco Brass Press

Henco Brass Press Fittings

Type: 13P



T-female centre
T-binnendraad
Pièce en T femelle
T-IG

Article number	Bag / Box	Type
13P-160416	10 pc / 60 pc	16x1/2"x16
13P-200420	10 pc / 50 pc	20x1/2"x20
13P-200520	10 pc / 30 pc	20x3/4"x20
13P-260426	5 pc / 30 pc	26x1/2"x26
13P-260526	5 pc / 30 pc	26x3/4"x26
13P-320532*	5 pc / 20 pc	32x3/4"x32

**TILL EXHAUSTION OF STOCK*

Type: 14P



T-male centre
T-buitendraad
Pièce en T mâle
T-AG

Article number	Bag / Box	Type
14P-160416	10 pc / 60 pc	16x1/2"x16
14P-200420	10 pc / 60 pc	20x1/2"x20
14P-200520	5 pc / 30 pc	20x3/4"x20
14P-260426*	5 pc / 30 pc	26x1/2"x26

**TILL EXHAUSTION OF STOCK*

Type: 15P



Straight coupling
Perssok
Manchon
Kupplung

Article number	Bag / Box	Type
15P-1616	10 pc / 200 pc	16x16
15P-1818*	10 pc / 150 pc	18x18
15P-2020	10 pc / 140 pc	20x20
15P-2626	5 pc / 80 pc	26x26
15P-3232	5 pc / 50 pc	32x32

**TILL EXHAUSTION OF STOCK*



Type: 16P



Reducing coupling
Verloopstuk
Réduction
Kupplung-reduziert

Article number	Bag / Box	Type
16P-2016	10 pc / 150 pc	20x16
16P-2018*	10 pc / 150 pc	20x18
16P-2616	5 pc / 100 pc	26x16
16P-2620	5 pc / 80 pc	26x20
16P-3216*	5 pc / 60 pc	32x16
16P-3220*	5 pc / 60 pc	32x20
16P-3226	5 pc / 60 pc	32x26

**TILL EXHAUSTION OF STOCK*

Type: 17P



Straight male adapter
Puntstuk
Raccord droit mâle
Übergangsfitting AG

Article number	Bag / Box	Type
17P-1603	10 pc / 150 pc	16x3/8"
17P-1604	10 pc / 150 pc	16x1/2"
17P-1605	10 pc / 150 pc	16x3/4"
17P-1804	10 pc / 150 pc	18x1/2"
17P-1805	10 pc / 150 pc	18x3/4"
17P-2004	10 pc / 150 pc	20x1/2"
17P-2005	10 pc / 150 pc	20x3/4"
17P-2605	5 pc / 80 pc	26x3/4"
17P-2606	5 pc / 80 pc	26x1"
17P-3206	5 pc / 50 pc	32x1"
17P-3207	5 pc / 40 pc	32x5/4"

Type: 17P-DZR (CW602N)



Straight male adapter
Puntstuk
Raccord droit mâle
Übergangsfitting AG

Article number	Bag / Box	Type
17P-1603DZR	10 pc / 150 pc	16x3/8"
17P-1604DZR	10 pc / 150 pc	16x1/2"



Henco Brass Press

Henco Brass Press Fittings

Type: 17P-CS (CW724N)



Straight male adapter
Puntstuk
Raccord droit mâle
Übergangsfitting

Article number	Bag	Type
17P-1604-CS	10 pc	16x1/2"
17P-2004-CS	10 pc	20x1/2"
17P-2005-CS	10 pc	20x3/4"
17P-2605-CS	10 pc	26x3/4"
17P-2606-CS	10 pc	26x1"

Type: 18P



Straight female adapter
Schroefbus
Raccord droit femelle
Übergangsfitting IG

Article number	Bag / Box	Type
18P-1604	10 pc / 150 pc	16x1/2"
18P-1804*	10 pc / 120 pc	18x1/2"
18P-2004	10 pc / 100 pc	20x1/2"
18P-2005	10 pc / 100 pc	20x3/4"
18P-2605	5 pc / 80 pc	26x3/4"
18P-2606	5 pc / 70 pc	26x1"
18P-3206	5 pc / 50 pc	32x1"
18P-3207	5 pc / 30 pc	32x5/4"

**TILL EXHAUSTION OF STOCK*

Type: 19P



Press fit adapter to eurocone
Aansluiting met wartel en euroconus koppeling
Raccordement avec raccord à visser eurocone
Anschlussverschraubung mit Eurokonus

Article number	Bag / Box	Type
19P-1405	10 pc / 150 pc	14x3/4"
19P-1605	10 pc / 150 pc	16x3/4"
19P-1805	10 pc / 150 pc	18x3/4"
19P-2005	10 pc / 140 pc	20x3/4"



Type: 24P



Radiator connection nickel-plated 300 mm copper pipe Ø15
Radiatoraansluitbocht vernikkeld met 300 mm koperbuis Ø15
Alimentation radiateur nickelé 300 mm tube de cuivre Ø15
Heizkörperanschluss vernickelt 300 mm Kupferrohr Ø15

Article number	Bag / Box	Type
24P-1604	2 pc / 50 pc	16x15
24P-2004*	2 pc / 50 pc	20x15

**TILL EXHAUSTION OF STOCK*

Type: 25P



Radiator connection nickel-plated 1100 mm copper pipe Ø15
Radiatoraansluitbocht vernikkeld met 1100 mm koperbuis Ø15
Alimentation radiateur nickelé 1100 mm tube de cuivre Ø15
Heizkörperanschluss vernickelt 1100 mm Kupferrohr Ø15

Article number	Bag	Type
25P-1604	2 pc	16x15

TILL EXHAUSTION OF STOCK

Type: 26P



Press fitting self-filling
Aansluiting met buitendraad, vlakke dichting
Raccord auto-étanche
Pressfitting mit AG flachdichtend

Article number	Bag / Box	Type
26P-1604	10 pc / 100 pc	16x1/2"
26P-1605	10 pc / 80 pc	16x3/4"
26P-2004	10 pc / 80 pc	20x1/2"
26P-2005	10 pc / 70 pc	20x3/4"
26P-2605	5 pc / 50 pc	26x3/4"
26P-2606	5 pc / 40 pc	26x1"
26P-3206*	5 pc / 25 pc	32x1"

**TILL EXHAUSTION OF STOCK*

Type: 26P-Z



Press fitting swivel adapter
Aansluiting met wartel, vlakke dichting
Raccord à visser, joint plat
Pressfitting mit IG flachdichtend ohne Nippel

Article number	Bag / Box	Type
26P-16Z05	10 pc / 80 pc	16x3/4"
26P-16Z04	10 pc / 150 pc	16x1/2"
26P-20Z05	10 pc / 70 pc	20x3/4"
26P-20Z04	10 pc / 150 pc	20x1/2"
26P-26Z05	5 pc / 50 pc	26x3/4"
26P-26Z06	5 pc / 40 pc	26x1"
26P-32Z06	5 pc / 40 pc	32x1"
26P-32Z07	5 pc / 40 pc	32x5/4"



Henco Brass Press

Henco Brass Press Fittings

Type: 26P-Z-DZR (CW602N)



Press fitting swivel adapter
 Aansluiting met wartel, vlakke dichting
 Raccord à visser, joint plat
 Pressfitting mit IG flachdichtend ohne Nippel

Article number	Bag	Type
26P-16ZO4DZR	10 pc	16x1/2"
26P-20ZO4DZR*	10 pc	20x1/2"
26P-20ZO5DZR*	10 pc	20x3/4"
26P-26ZO5DZR*	5 pc	26x3/4"

*TILL EXHAUSTION OF STOCK

Type: N



Nipple for article 26P-Z
 Nippel voor artikel 26P-Z
 Nipple pour article 26P-Z
 Nippel für Artikel 26P-Z

Article number	Bag / Box	Type
N04	10 pc / 250 pc	1/2"x1/2"
N05	10 pc / 200 pc	3/4" x 3/4"
N06	25 pc / 250 pc	1"x1"

Type: N (INOX 316 L)



Nipple for article 26P-Z INOX
 Nippel voor artikel 26P-Z INOX
 Nipple pour article 26P-Z INOX
 Nippel für Artikel 26P-Z INOX

Article number	Bag / Box	Type
N0404-X	10 pc / 100 pc	1/2"x1/2"
N0505-X	10 pc / 100 pc	3/4" x 3/4"
N0606-X	10 pc / 100 pc	1"x1"

Type: 27P



Elbow 45°
 Knie 45°
 Coude 45°
 Winkel 45°

Article number	Bag / Box	Type
27P-2626	5 pc / 50 pc	26x26
27P-3232	5 pc / 30 pc	32x32

Type: 28P



Double backplate elbow female, build up
 Dubbele muurplaat binnendraad, opbouw
 Culasse double pour sanitaire femelle
 Sanitär Wandscheibe doppelt IG, Oberbau

Article number	Bag / Box	Type
28P-14041604-1	1 pc / 20 pc	14x1/2" - 16x1/2" (38 mm)
28P-16041604-1	1 pc / 20 pc	16x1/2" - 16x1/2" (37 mm)



Type: 28PV



Double backplate elbow female, build-in
Dubbele muurplaat binnendraad, inbouw
Culasse double surélevé
Wandwinkel doppelt erhöht

Article number	Bag / Box	Type
28PV-16031603-1	1 pc / 15 pc	16x3/8" - 16x3/8" (37 mm)
28PV-16041604-1	1 pc / 15 pc	16x1/2" - 16x1/2" (37 mm)

Type: 28PF

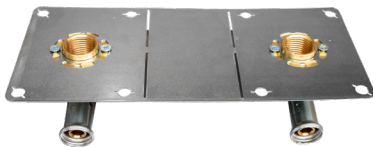

Double backplate elbow female for plaster
Dubbel muurplaat binnendraad voor gips
Culasse double femelle pour plâtre
Wandscheibe doppelt IG für Gips

Article number	Bag / Box	Type
28PF-16041604	1 pc / 15 pc	16x1/2" - 16x1/2"
28PF-20042004	1 pc / 15 pc	20x1/2" - 20x1/2"

Type: 29P (CW617N)



Press fitting with adapter
Persfitting met adapter
Manchon à sertir avec adaptateur
Pressfitting mit Adapter

Article number	Bag / Box	Type
29P-1615	10 pc / 120 pc	16x15
29P-2015	10 pc / 120 pc	20x15
29P-2022	10 pc / 70 pc	20x22
29P-2622	10 pc / 70 pc	26x22
29P-2628	5 pc / 60 pc	26x28
29P-3228	5 pc / 50 pc	32x28

Type: 29P-CS (CW724N)



Press fitting with adapter
Persfitting met adapter
Manchon à sertir avec adaptateur
Pressfitting mit Adapter

Article number	Bag / Box	Type
29P-1612-CS	10 pc / 120 pc	16x12
29P-2018-CS	10 pc / 70 pc	20x18



Henco Brass Press

Henco Brass Press Fittings

Type: 30P



Press-fit adapter to copper compression
Overgangsstuk Henco pers x koperbuis knelkoppeling
Manchon à sertir x tube en cuivre manchon à visser
Pressfitting x Klemmverbinder für Kupferrohr

Article number	Bag / Box	Type
30P-1614S*	10 pc / 120 pc	16x14
30P-1615S-2	2 pc / 100 pc	16x15
30P-2022S	10 pc / 100 pc	20x22
30P-2622S	10 pc / 80 pc	26x22

**TILL EXHAUSTION OF STOCK*

Type: 31P



Double crossover tee
Kruisingsvrij T-stuk
Double T croisé
Kreuzungs-T-Stück

Article number	Bag / Box	Type
31P-161616*	1 pc / 20 pc	16x16x16
31P-161620*	1 pc / 20 pc	16x16x20
31P-201616*	1 pc / 20 pc	20x16x16
31P-201620*	1 pc / 20 pc	20x16x20
31P-202020	1 pc / 20 pc	20x20x20

** TILL EXHAUSTION OF STOCK*

Type: ISO-BOX



Insulation box for double crossover tee
Isolatiebox voor kruisingsvrij T-Stuk
Boîte d'isolation pour T croisé
Isolierboxen für Kreuzungs-T-Stück

Article number	Bag / Box	Type
ISO-BOX	1 pc / 180 pc	124x124x55mm

Type: 33P



Nickel plated press-fit adapter to eurocone, 90°
Aansluiting met wartel en euroconus-koppeling vernikkeld, 90°
Raccord à visser eurocone nickelé, 90°
Anschlussverschraubung mit Eurokonus vernickelt, 90°

Article number	Bag / Box	Type
33P-1605	10 pc / 60 pc	16x3/4"



Type: 34P



Henco press swivel adapter with flat sealing, 90°
 Aansluiting met wartel vlakdichtend, 90°
 Raccord à visser joint plat, 90°
 Anschlussverschraubung mit AG flachdichtend, 90°

Article number	Bag / Box	Type
34P-1604	10 pc / 120 pc	16x1/2"
34P-1605	10 pc / 120 pc	16x3/4"
34P-2004	10 pc / 80 pc	20x1/2"
34P-2005	10 pc / 80 pc	20x3/4"
34P-3206	5 pc / 40 pc	32x1"

Type: 34P-CS (CW724N)



Henco press swivel adapter with flat sealing, 90°
 Aansluiting met wartel vlakdichtend, 90°
 Raccord à visser joint plat, 90°
 Anschlussverschraubung mit AG flachdichtend, 90°

Article number	Bag / Box	Type
34P-1605-CS	10 pc / 120 pc	16x1/2"
34P-2004-CS	10 pc / 80 pc	20x1/2"
34P-2005-CS	10 pc / 80 pc	20x3/4"
34P-2605-CS	10 pc / 70 pc	26x3/4"

Type: 35P



Press-fit adapter to copper press (M-profile)
 Overgangsstuk Henco pers naar koper pers (M-profiel)
 Manchon à sertir vers cuivre à sertir (profil M)
 Pressfitting Henco zu Pressfitting für Kupferrohr (M-profile)

Article number	Bag / Box	Type
35P-1615P	10 pc / 150 pc	16x15
35P-2022P	10 pc / 80 pc	20x22

TILL EXHAUSTION OF STOCK

Type: 36P



Press-fit adapter to copper press (V, M & SA profile)
 Overgangsstuk Henco pers naar koper pers (V, M & SA profiel)
 Manchon à sertir Henco vers cuivre à sertir (profil M, V & SA)
 Pressfitting Henco zu Pressfitting für Kupferrohr (Presskontur M, V & SA)

Article number	Bag / Box	Type
36P-1612P	10 pc / 160 pc	16x12Cu
36P-1614P	10 pc / 150 pc	16x14Cu
36P-1615P	10 pc / 150 pc	16x15Cu
36P-1616P	10 pc / 120 pc	16x16Cu
36P-2015P	10 pc / 120 pc	20x15Cu
36P-2018P	10 pc / 120 pc	20x18Cu
36P-2022P	10 pc / 80 pc	20x22Cu
36P-2622P	10 pc / 70 pc	26x22Cu
36P-2628P	10 pc / 70 pc	26x28Cu
36P-3228P	5 pc / 50 pc	32x28Cu



Henco Brass Press

Henco Brass Press Fittings

Type: 37P



Press-fit adapter to copper pipe, elbow
 Persfitting verlengd met koperbuis, knie
 Coude à sertir avec tube en cuivre soudé
 Pressfitting mit geschweisstem Kupferrohr, Winkel

Article number	Bag / Box	Type
37P-1412L*	10 pc / 60 pc	14x12 (227/200mm)
37P-1612L	10 pc / 40 pc	16x12 (227/200mm)
37P-1615L	10 pc / 40 pc	16x15 (227/200mm)

*TILL EXHAUSTION OF STOCK

Type: 38P

NEW PRODUCT



Straight compression adapter to copper press (V, M & SA profile)
 Rechte schroefkoppeling naar koper pers (V, M & SA profiel)
 Raccord à visser droit vers cuivre à sertir (profil M, V & SA)
 Schraubfitting zu Pressfitting für Kupferrohr (Presskontur M, V & SA)

Article number	Bag / Box	Type
38P-2622P	10 pc / 60 pc	26x22Cu
38P-3228P	5 pc / 40 pc	32x28Cu

Type: 39P



Double bend for radiator nickel-plated 300 mm copper pipe Ø15, connected end
 Dubbele radiatorbocht koperbuis Ø15, 300 mm, vernikkeld, doorverbonden einde
 Double courbe radiateur nickelé 300 mm tube en cuivre Ø15, bout rattaché
 Doppelter Heizkörperwinkel vernickelt 300 mm Kupferrohr Ø15, durchgestelltes Ende

Article number	Bag / Box	Type
39P-160450	1 pc / 8 pc	16x1/2" (AS = 50 mm) Interaxis 50 mm

Type: 40P



Press-fit elbow to copper compression
 Knie Henco pers x koperbuis knelkoppeling
 Coude à sertir x tube en cuivre manchon à visser, 90°
 Winkel Henco Press x Klemmverbinder für Kupferrohr

Article number	Bag / Box	Type
40P-1615S	10 pc / 60 pc	16x15 Cu
40P-2022S	10 pc / 60 pc	20x22 Cu
40P-2622S	10 pc / 60 pc	26x22 Cu



Type: 41P



Brass press coupling with valve F-connection
Messing perskoppeling met F-aansluiting
Connecteur F à sertir
Pressfittung mit F-Connection

Article number	Bag / Box	Type
41P-16	10 pc / 150 pc	16
41P-20	10 pc / 100 pc	20
41P-26	10 pc / 100 pc	26

TILL EXHAUSTION OF STOCK

Type: 42P



Straight coupling PE-Xc
Doorverbinder recht PE-Xc
Manchon PE-Xc
Kupplung PEX-Xc

Article number	Bag / Box	Type
42P-161615	10 pc / 200 pc	16x2 - 16x1,75
42P-202019	10 pc / 140 pc	20x2 - 20x1,9

Type: 43P



T-piece Henco press 16mm x compression 15mm x press 16mm
T-stuk Henco pers 16mm x koper knel 15mm x Henco pers 16mm
Piece en T Henco sertir 16mm x machon à visser 15mm x Henco sertir 16mm
T-stuck Henco press 16mm x Klemmverbinder 15mm x press 16mm

Article number	Bag / Box	Type
43P-161516	2 pc / 50 pc	16x15x16



Henco Brass Press

Henco Brass Press Fittings

1 Type: 44P



Bend 90° female connection toilet reservoir
Aansluitbocht inbouwreservoir toilet
Coude 90° femelle connexion réservoir toilet
Winkel 90° IG Anschluss Reservoir-Toilette

Article number	Bag / Box	Type
44P-1604	10 pc / 60 pc	16x1/2"

7 Type: 45P



Straight connection female toilet reservoir
Rechte aansluiting binnendraad toiletreservoir
Raccord droit femelle réservoir toilet
Anschluss IG Reservoir-Toilette

Article number	Bag / Box	Type
45P-1604	10 pc / 150 pc	16x1/2"

14 Type: 46P

NEW
PRODUCT



90° Compression adapter to copper press (V, M & SA profile)
90° schroefkoppeling naar koper pers (V, M & SA profiel)
Raccord à visser 90° vers cuivre à sertir (profil M, V & SA)
Schraubfitting 90° zu Pressfitting für Kupferrohr (Presskontur M, V & SA)

Article number	Bag / Box	Type
46P-2622P	10 pc / 40 pc	26x22Cu
46P-3228P	5 pc / 20 pc	32x28Cu

Type: 47P

NEW
PRODUCT



Transition Coupling U-TH-H to Henco
Overgangskoppeling U-TH-H naar Henco
Raccord de transition U-TH-H vers Henco
Übergangskupplung U-TH-H auf Henco

Article number	Bag / Box	Type
47P-20H20	10 pc / 140 pc	20x2,25 - 20x2,0
47P-25H26	5 pc / 80 pc	25x2,5 - 26x3,0



NEW*
PRODUCT

Type: 48P



T- female Lateral
T-binnendraad lateraal
Pièce en T femelle latérale
T-IG seitlich

Article number	Bag / Box	Type
48P-202004	10 pc	20x20x1/2"
48P-262604	5 pc	26x26x1/2"
48P-323204	5 pc	32x32x1/2"

Type: 52P



Easy mounting/repair fitting
Eenvoudige montage/reparatie fitting
Raccord montage/réparation facile
Einfache Montage/Reparatur Fitting

Article number	Bag / Box	Type
52P16	1 pc / 40 pc	16x16
52P20	1 pc / 30 pc	20x20
52P26	1 pc / 30 pc	26x26
52P32	1 pc / 20 pc	32x32

for ø40, 50 and 63: chapter 2, type 53PK

Type: WALL BOX

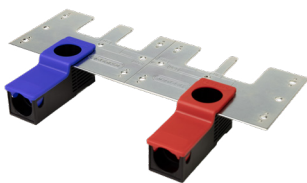

Wall Box – press
Wall Box – pers
Wall Box – sertir
Wall Box – Press

Article number	Box / Big Box	Type
WBP-1604-BL*	10 pc / 300 pc	16x1/2" blue
WBP-1604-RO*	10 pc / 300 pc	16x1/2" red
WBP-1604	1 pc / 25 pc	16x1/2" blue & red
WBP-2004-BL*	10 pc / 300 pc	20x1/2" blue
WBP-2004-RO*	10 pc / 300 pc	20x1/2" red
WBP-2004	1 pc / 25 pc	20x1/2" blue & red

*Without mounting bracket 'WBPL-X'

Type: WB-PLATE

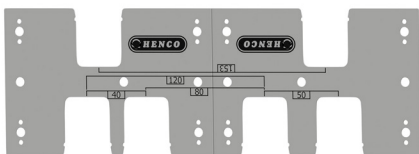

Wall Box mounting bracket
Wall Box montage plaat
Wall Box plaque de montage
Wall Box Montage Bügel

Article number	Box / Big Box	Type
WBPL-X	10 pc / 60 pc	GALV. STEEL



Henco Brass Press

Henco Brass Press Fittings

1 Type: P-PIPESTOP

2

3

4

5

6

7

8

9

10

11

12

13

14



Stop end press for pipe
Eindstop voor buis Pers
Bouchon à sertir pour tube
Endkappe Press für Rohre

Article number	Bag / Box	Type
P-PIPESTOP16	10 pc / 250 pc	16x2
P-PIPESTOP20	10 pc / 200 pc	20x2
P-PIPESTOP26	10 pc / 120 pc	26x3
P-PIPESTOP32	10 pc / 70 pc	32x3



Gas: only allowed in countries where a HENCO GAS testing + certificate is available! (see www.henco.be)

Gas: enkel toegelaten in landen waar er een HENCO GAS keur is + een certificaat voorhanden is! (zie www.henco.be)

Gaz: seulement permis dans des pays où le contrôle a eu lieu + certificat est disponible! (Consultez www.henco.be)

Gas: nur zugelassen in Länder wo HENCO GAS Prüfung geschehen ist + Zertifikat vorhanden ist! (Siehe www.henco.be)

Type: 1PG



Elbow 90°
Knie 90°
Coude 90°
Winkel 90°

Article number	Bag / Box	Type
1PG-1616*	10 pc / 150 pc	16x16
1PG-2020	10 pc / 80 pc	20x20
1PG-2626	5 pc / 50 pc	26x26

*TILL EXHAUSTION OF STOCK

Type: 2PG



Backplate elbow female (52 mm)
Muurplaat binnendraad (52 mm)
Culasse femelle (52 mm)
Wandscheibe IG (52 mm)

Article number	Bag / Box	Type
2PG-1604	10 pc / 50 pc	16x1/2" (52 mm)
2PG-2004	10 pc / 50 pc	20x1/2" (52 mm)
2PG-2005	10 pc / 50 pc	20x3/4" (46 mm)
2PG-2605	5 pc / 50 pc	26x3/4" (46 mm)

Type: 2PG-K



Backplate elbow female, short model
Muurplaat binnendraad, laag
Culasse femelle, modèle court
Wandscheibe IG, kurzes Modell

Article number	Bag / Box	Type
2PG-1604K	10 pc / 50 pc	16x1/2" (35mm)



Henco Brass Press

Henco Brass Press Fittings Gas

Type: 5PG



Elbow 90° male adapter
Knie 90° buitendraad
Coude 90° mâle
Winkel 90° AG

Article number	Bag / Box	Type
5PG-1604	10 pc / 150 pc	16x1/2"
5PG-2005	10 pc / 80 pc	20x3/4"

TILL EXHAUSTION OF STOCK

Type: 6PG



Elbow 90° female adapter
Knie 90° binnendraad
Coude 90° femelle
Winkel 90° IG

Article number	Bag / Box	Type
6PG-1604	10 pc / 120 pc	16x1/2"
6PG-2004	10 pc / 120 pc	20x1/2"
6PG-2005	10 pc / 50 pc	20x3/4"

Type: 9PG



T-piece Gas
T-Stuk Gas
Pièce T Gaz
T-Stück Gas

Article number	Bag / Box	Type
9PG-202020	10 pc / 50 pc	20x20x20
9PG-262626	5 pc / 30 pc	26x26x26

TILL EXHAUSTION OF STOCK



Type: 10PG



T-reduced centre
T-verlopend
Pièce en T réduit
T-reduziert

Article number	Bag / Box	Type
10PG-262026	5 pc / 30 pc	26x20x26

TILL EXHAUSTION OF STOCK

Type: 11PG



T-branch and line reduced
T-2x verlopend
Pièce en T 2x réduit
T-2x reduziert

Article number	Bag / Box	Type
11PG-201616	10 pc / 50 pc	20x16x16
11PG-262020	5 pc / 30 pc	26x20x20

TILL EXHAUSTION OF STOCK

Type: 13PG

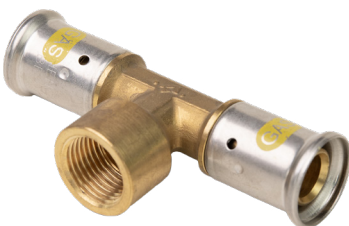

T-female centre
T-binnendraad
Pièce en T femelle
T-IG

Article number	Bag / Box	Type
13PG-200420	10 pc / 50 pc	20x1/2"x20
13PG-260426	5 pc / 30 pc	26x1/2"x26

TILL EXHAUSTION OF STOCK

- 1
- 2
- 3
- 4
- 5
- 6
- 7
- 8
- 9
- 10
- 11
- 12
- 13
- 14



Henco Brass Press

Henco Brass Press Fittings Gas

Type: 15PG



Straight coupling
Perssok
Manchon
Kupplung

Article number	Bag / Box	Type
15PG-1616	10 pc / 200 pc	16x16
15PG-2020	10 pc / 140 pc	20x20
15PG-2626	5 pc / 80 pc	26x26
15PG-3232	5 pc / 50 pc	32x32

TILL EXHAUSTION OF STOCK

Type: 16PG



Reducing coupling
Verloopstuk
Réduction
Kupplung-reduziert

Article number	Bag / Box	Type
16PG-2016	10 pc / 150 pc	20x16
16PG-2620*	5 pc / 80 pc	26x20
16PG-3226*	5 pc / 40 pc	32x26

**TILL EXHAUSTION OF STOCK*

Type: 17PG



Straight male adapter
Puntstuk
Raccord droit mâle
Übergangsfitting AG

Article number	Bag / Box	Type
17PG-1604	10 pc / 150 pc	16x1/2"
17PG-2004	10 pc / 150 pc	20x1/2"
17PG-2005	10 pc / 150 pc	20x3/4"
17PG-2605	5 pc / 80 pc	26x3/4"
17PG-2606	5 pc / 80 pc	26x1"
17PG-3206	5 pc / 50 pc	32x1"



Type: 18PG



Straight female adapter
Schroefbus
Raccord droit femelle
Übergangsfitting IG

Article number	Bag / Box	Type
18PG-1604	10 pc / 150 pc	16x1/2"
18PG-2004	10 pc / 100 pc	20x1/2"
18PG-2005	10 pc / 100 pc	20x3/4"
18PG-2605	5 pc / 80 pc	26x3/4"
18PG-2606*	5 pc / 70 pc	26x1"
18PG-3206	5 pc / 50 pc	32x1"

**TILL EXHAUSTION OF STOCK*

Type: 30PG



Press-fit adapter to copper press compression
Overgangsstuk Henco pers x koperbuis knelkoppeling
Manchon à sertir Henco vers tube de cuivre manchon à visser
Pressfitting x Klemmverbinder für Kupferrohr

Article number	Bag / Box	Type
30PG-1615S-2	2 pc / 100 pc	16x15
30PG-2022S	10 pc / 100 pc	20x22
30PG-2622S	10 pc / 80 pc	26x22

Type: 36PG



Press-fit adapter to copper press (V, M & SA profile)
Overgangsstuk Henco pers naar koper pers (V, M & SA profiel)
Manchon à sertir Henco vers cuivre à sertir (profil M, V & SA)
Pressfitting Henco zu Pressfitting für Kupferrohr (CuSi)

Article number	Bag / Box	Type
36PG-1615P	10 pc / 150 pc	16x15Cu
36PG-2015P	10 pc / 120 pc	20x15Cu
36PG-2022P	10 pc / 120 pc	20x22Cu
36PG-2615P	10 pc / 100 pc	26x15Cu
36PG-2622P	10 pc / 100 pc	26x22Cu



Henco Brass Compression

	<i>Page</i>
<i>Henco Brass Compression Fittings</i>	<i>101</i>

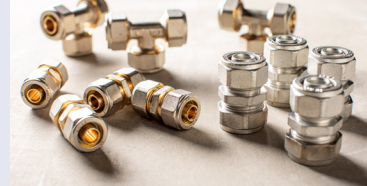

Type: 1



Straight male adapter
Puntstuk
Raccord droit mâle
Kupplung AG

Article number	Bag / Box	Type
1-1403C-S**	10 pc / 250 pc	14x3/8"
1-1404-S*	10 pc / 250 pc	14x1/2"
1-1604-S	10 pc / 250 pc	16x1/2"
1-1605-S	10 pc / 150 pc	16x3/4"
1-1804-S	10 pc / 150 pc	18x1/2"
1-1805*	10 pc / 150 pc	18x3/4"
1-2004-S	10 pc / 120 pc	20x1/2"
1-2005-S	10 pc / 150 pc	20x3/4"
1-2605-S	5 pc / 80 pc	26x3/4"
1-2606-S	5 pc / 80 pc	26x1"
1-3206-S	5 pc / 50 pc	32x1"

** TILL EXHAUSTION OF STOCK*
**FOR FUEL OIL*

Type: 2



Straight coupling
Doorverbinder recht
Manchon
Kupplung doppelt

Article number	Bag / Box	Type
2-1616-S	10 pc / 200 pc	16x16
2-2020-S	10 pc / 120 pc	20x20
2-2626-S*	5 pc / 60 pc	26x26

** TILL EXHAUSTION OF STOCK*

Type: 3

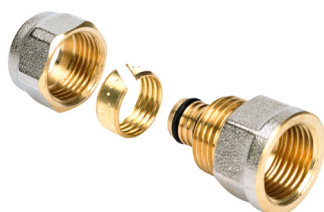

Straight female adapter
Schroefbus
Raccord droit femelle
Kupplung IG

Article number	Bag / Box	Type
3-1604-S	10 pc / 200 pc	16x1/2"
3-1804-S	10 pc / 120 pc	18x1/2"
3-2004-S	10 pc / 120 pc	20x1/2"
3-2005-S	10 pc / 120 pc	20x3/4"
3-2605-S	5 pc / 60 pc	26x3/4"
3-2606-S*	5 pc / 50 pc	26x1"
3-3206A*	5 pc / 50 pc	32x1

**TILL EXHAUSTION OF STOCK*



Henco Brass Compression

Henco Brass Compression Fittings

1 Type: 4

2

3

4

5

6



Elbow 90°
Knie 90°
Coude 90° mâle
Winkel 90°

Article number	Bag / Box	Type
4-1616-S	10 pc / 150 pc	16x16
4-2020-S	10 pc / 60 pc	20x20
4-2626-S	5 pc / 40 pc	26x26
4-3232-S*	1 pc / 32 pc	32X32

* TILL EXHAUSTION OF STOCK

7

8 Type: 5

8

9

10

11

12

13

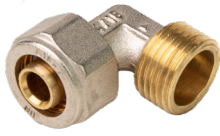

Elbow 90° male adapter
Knie 90° buitendraad
Coude 90° mâle
Winkel 90° AG

Article number	Bag / Box	Type
5-1604-S	10 pc / 150 pc	16x1/2"
5-1804*	10 pc / 150 pc	18x1/2"
5-2005-S	10 pc / 100 pc	20x3/4
5-2606-S	5 pc / 40 pc	26x1

* TILL EXHAUSTION OF STOCK

14

Type: 6



Elbow 90° female adapter
Knie 90° binnendraad
Coude 90° femelle
Winkel 90° IG

Article number	Bag / Box	Type
6-1604-S	10 pc / 150 pc	16x1/2"
6-1804*	10 pc / 90 pc	18x1/2"
6-2004-S	10 pc / 80 pc	20x1/2
6-2005-S	10 pc / 80 pc	20x3/4"

* TILL EXHAUSTION OF STOCK

Type: 7



Backplate elbow with branch connection
Sanitair muurplaat binnendraad
Culasse pour sanitaire femelle
Sanitär Wandscheibe

Article number	Bag / Box	Type
7-1604-S	10 pc / 80 pc	16x1/2" (46 mm)

Henco Brass Compression

Henco Brass Compression Fittings

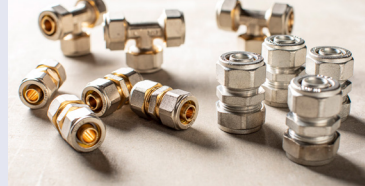

Type: 8



T-piece
T-stuk
Pièce en T
T-Stück

Article number	Bag / Box	Type
8-161616-S	10 pc / 80 pc	16x16x16

Type: 10



Nut, insert and jointing ring
Moer, insert en klemring
écrou, insert et bicône
Mutte, Stuthülse und Klemmring

Article number	Bag / Box	Type
10-1604SN	10 pc / 200 pc	16x1/2

TILL EXHAUSTION OF STOCK

Type: 13



Nut, insert and jointing ring to copper compression
Adapter Henco buis naar messing knelverbinding
Raccord à visser cuivre vers multicouche
Verbindungsstück Kupfer Schraubfitting auf Henco

Article number	Bag / Box	Type
13-1415-2*	2 pc / 150 pc	14x15 Cu
13-1615A-2*	2 pc / 150 pc	16x15 Cu
13-1615HA-2	2 pc / 150 pc	16x15 Cu
13-2022HA-2	2 pc / 100 pc	20x22 Cu
13-2628H-2	2 pc / 80 pc	26x28 Cu

*Nickel plated nut

Type: 13-VH



Adapter for Henco compression to copper compression
Adapter Henco buis naar koper knelverbinding
Adaptateur raccord à visser cuivre vers multicouche
Verbindungsstück für Henco Schraubfitting auf Kupfer Schraubfitting

Article number	Bag / Box	Type
13-V2622H-2	2 pc / 50 pc	26x22 Cu

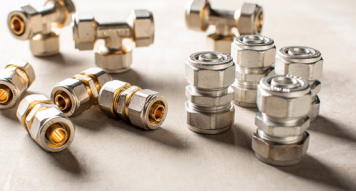

Henco Brass Compression

Henco Brass Compression Fittings

Type: 24



Compression coupling Henco x copper tube
Overslagstuk Henco knel x koperbuis knelverbinding
Raccord droit Henco x tube de cuivre manchon à visser
Gerade Fitting Henco x Klemmverbinder für Kupferrohr

Article number	Bag / Box	Type
24-1615-S	10 pc / 200 pc	16x15
24-2022*	10 pc / 100 pc	20x22
24-2622*	5 pc / 50 pc	26x22

* TILL EXHAUSTION OF STOCK

Type: EK



Nickel plated eurocone (3/4" F)
Euroconus schroefkoppeling (3/4" F)
Raccord à visser eurocone (3/4" F)
Schraubfitting Eurokonus (3/4" F)

Article number	Bag	Type
EK12-2	2 pc / 100 pc	Ø12x3/4"
EK14-2	2 pc / 100 pc	Ø14x3/4"
EK16-2	2 pc / 100 pc	Ø16x3/4"
EK17-2	2 pc / 100 pc	Ø17x3/4"
EK18-2	2 pc / 100 pc	Ø18x3/4"
EK20-2	2 pc / 100 pc	Ø20x3/4"

Type: EK15



Eurocone (3/4" F) for copper tube 15mm
Euroconus-schroefkoppeling (3/4" F) voor koperbuis 15mm
Raccord à visser eurocone (3/4" F) pour tube de cuivre 15mm
Schraubfitting Eurokonus (3/4") für Kupferrohr 15mm

Article number	Box / Big Box	Type
EK15	25 pc / 300 pc	Ø15x3/4" EK

Type: SPLIT



Split olive for eurocone
Klemring voor EK
Anneau de serrage pour raccordement eurocone
Klemring für EK

Article number	Bag	Type
SPLIT14*	10 pc	14
SPLIT16	10 pc	16
SPLIT20*	10 pc	20

* TILL EXHAUSTION OF STOCK

Henco Brass Compression

Henco Brass Compression Fittings

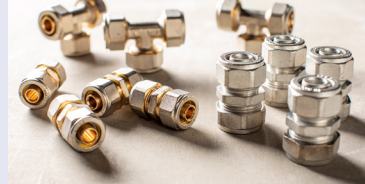

Type: SPLIT-S



Henco Split ring for compression fittings (not for EK)
Henco Klemring voor schroeffitting (Niet voor EK'S)
Anneau de serrage pour raccords à visser (pas pour EK)
Klemring für Schraubfitting (nicht für EK)

Article number	Bag / Box	Type
SPLIT-S16	10 pc / 1500 pc	Ø16
SPLIT-S20*	10 pc / 500 pc	Ø20
SPLIT-S26*	10 pc	Ø26

*TILL EXHAUSTION OF STOCK

Type: AB



Elbow 90° eurocone elbow (3/4"M)
Knie 90° voor euroconus-aansluiting (3/4"M)
Coude 90° pour raccordement eurocone (3/4"M)
Winkel 90° für Eurokonusanschluß (3/4"M)

Article number	Bag / Box	Type
AB1420	10 pc / 100 pc	14x20

TILL EXHAUSTION OF STOCK

Type: AT



Eurocone equal T-piece
T-stuk voor euroconus-aansluiting (3/4"M)
Pièce en T pour raccordement eurocone (3/4"M)
T-Stück für Eurokonusanschluß (3/4"M)

Article number	Bag / Box	Type
AT1420	10 pc / 100 pc	3/4"x3/4"x3/4" for EK

TILL EXHAUSTION OF STOCK

Type: AD



Eurocone straight coupling (3/4"M)
Overgangsstuk met 2x euroconus-aansluiting (3/4"M)
Mamelon 2x raccordement eurocone (3/4"M)
Nippel für 2x Eurokonusanschluss

Article number	Bag / Box	Type
AD-EKEK	10 pc / 200 pc	3/4"x3/4" for EK

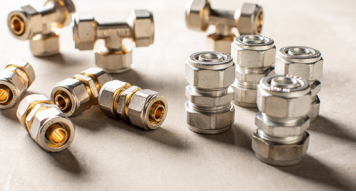

Henco Brass Compression

Henco Brass Compression Fittings

Type: AN



Straight eurocone connection (3/4" M) to 1/2" male adapter
 Recht overgangsstuk 1/2" M met O-ring en EK-aansluiting (3/4" M)
 Manchon droit mâle 1/2" avec joint torique et eurocone
 Nippel AG 1/2" mit O-ring und Eurokonusanschluss (3/4" M)

Article number	Bag / Box	Type
AN1420	10 pc / 250 pc	1/2"x3/4" for EK

Type: 3EK



Double backplate elbow female, 2x eurocone connection
 Sanitair doorstroommuurplaat binnendraad dubbel EC
 Culasse double, 2x raccordement eurocone
 Wandscheibe doppelt IG, 2x Eurokonusanschluss

Article number	Bag / Box	Type
3EK-050405	5 pc / 40 pc	3/4"x1/2"x3/4"

TILL EXHAUSTION OF STOCK

Type: WBS



Wall Box - compression
 Wall Box - schroef
 Wall Box - compression
 Wall Box - Schraub

Article number	Box / Big Box	Type
WBS-1604-RO*	10 pc / 300 pc	16x1/2" red
WBS-1604-BL*	10 pc / 300 pc	16x1/2" blue
WBS-1604	1 pc / 40 pc	16x1/2" red & blue

*Without mounting bracket WBPL-X



Henco Wall Box
 Instruction video



Type: WB-PLATE

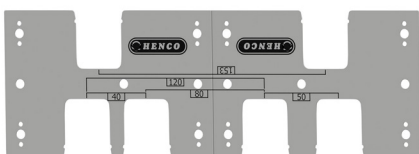

Wall Box mounting bracket
 Wall Box montage plaat
 Wall Box plaque de montage
 Wall Box Montage Bügel

Article number	Box / Big Box	Type
WBPL-X	10 pc / 60 pc	GALV. STEEL

Henco Brass Compression

Henco Brass Compression Fittings



Type: 2C



Wallplate horizontal 1/2"x1/2"
Horizontale/rechtdoor muurplaat 1/2"x1/2"
Culasse horizontale 1/2"x1/2"
Wandscheibe horizontal 1/2"x1/2"

Article number	Bag / Box	Type
2C-0404	10 pc / 100 pc	1/2"

TILL EXHAUSTION OF STOCK

- 1
- 2
- 3
- 4
- 5
- 6
- 7
- 8
- 9
- 10
- 11
- 12
- 13
- 14



Henco Manifolds

	<i>Page</i>
<i>Henco Pro-Flow Manifold</i>	109
<i>Henco Full Flow Manifold</i>	112
<i>Henco Brass Manifolds</i>	117
<i>Henco Manifold Accessories</i>	121

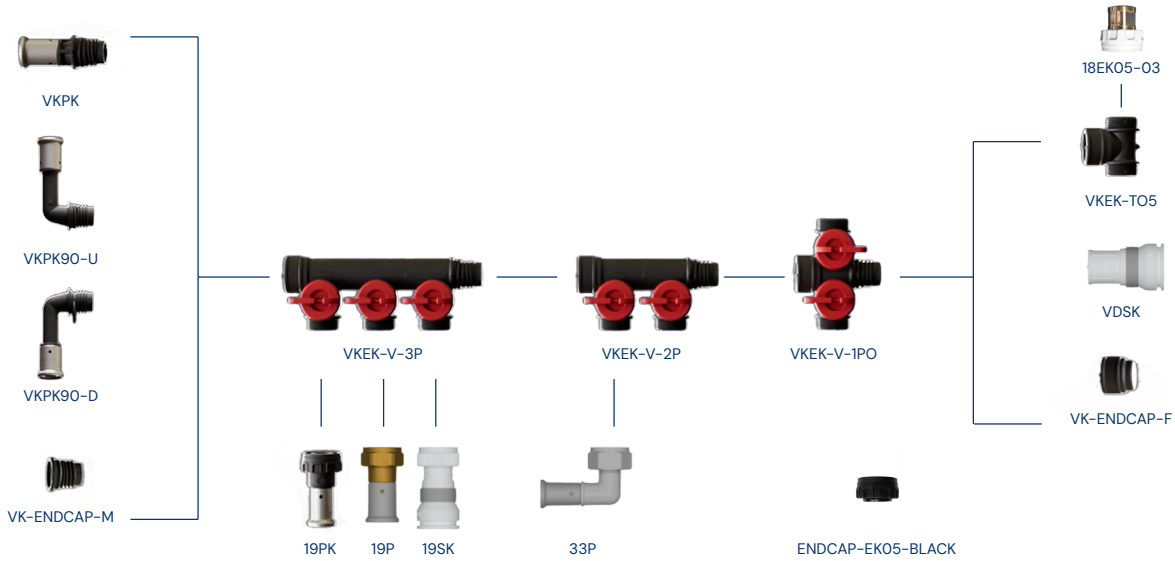

- 1
- 2
- 3
- 4
- 5
- 6
- 7
- 8
- 9
- 10
- 11
- 12
- 13
- 14

Type: VKEK-V-1PO



Synthetic manifold 1x PO euroconus with valves
Synthetische manifold 1x PO euroconus met kraantjes
Collecteur synthétique 1x PO eurocone avec robinets
Synthetischer Verteiler 1x PO Eurokonus mit Hähnen

Article number	Bag / Box	Type
VKEK-V-1PO-BLUE	1 pc / 20 pc	1x3/4" Blue
VKEK-V-1PO-GREEN	1 pc / 20 pc	1x3/4" Green
VKEK-V-1PO-RED	1 pc / 20 pc	1x3/4" Red
VKEK-V-1PO-BLACK	1 pc / 20 pc	1x3/4" Black

Type: VKEK-V-2P



Synthetic manifold 2x P euroconus with valves
Synthetische manifold 2x P euroconus met kraantjes
Collecteur synthétique 2x P eurocone avec robinets
Synthetischer Verteiler 2x P Eurokonus mit Hähnen

Article number	Bag / Box	Type
VKEK-V-2P-BLUE	1 pc / 20 pc	2x3/4" Blue
VKEK-V-2P-GREEN	1 pc / 20 pc	2x3/4" Green
VKEK-V-2P-RED	1 pc / 20 pc	2x3/4" Red
VKEK-V-2P-BLACK	1 pc / 20 pc	2x3/4" Black

Type: VKEK-V-3P



Synthetic manifold 3x P euroconus with valves
Synthetische manifold 3x P euroconus met kraantjes
Collecteur synthétique 3x P eurocone avec robinets
Synthetischer Verteiler 3x P Eurokonus mit Hähnen

Article number	Bag / Box	Type
VKEK-V-3P-BLUE	1 pc / 15 pc	3x3/4" Blue
VKEK-V-3P-GREEN	1 pc / 15 pc	3x3/4" Green
VKEK-V-3P-RED	1 pc / 15 pc	3x3/4" Red
VKEK-V-3P-BLACK	1 pc / 15 pc	3x3/4" Black



Henco Manifolds

Henco Pro-Flow Manifold

1 Type: VKEK-T05

NEW PRODUCT



T-Connection Piece - 2x eurocone
T-aansluitstuk voor verdeler - 2x euroconus
Raccord en T pour collecteur - 2x eurocone
T-Stück für Verlauf - 2x Eurokonus

Article number	Bag / Box	Type
VKEK-T05	1 pc / 50 pc	2x EK

6 Type: VK-ENDCAP-M

NEW PRODUCT



Endcap male for manifold VKEK
Eindstop buitendraad voor verdeler VKEK
Bouchon mâle pour collecteur VKEK
Endkappe AG für Verteiler VKEK

Article number	Bag / Box	Type
VKEK-ENDCAP-M	1 pc / 150 pc	M

12 Type: VKEK-ENDCAP-F

NEW PRODUCT



Stop end female for manifold VKEK
Eindstop binnendraad voor verdeler VKEK
Bouchon femelle pour collecteur VKEK
Endkappe IG für Verteiler VKEK

Article number	Bag / Box	Type
VKEK-ENDCAP-F	1 pc / 180 pc	F

14 Type: VKEK-B05

NEW PRODUCT



Bracket for Pro-Flow Manifold
Beugel voor Pro-Flow Manifold
Double support pour Pro-Flow collecteurs
Halter für Pro-Flow Verteiler

Article number	Bag / Box	Type
VKEK-B05	1 pc / 25 pc	B05

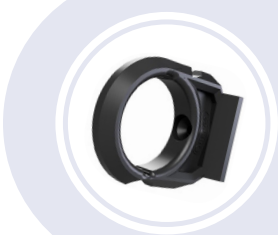

Did you know...

VKEK-CLIP is also available separately.

Find more information on [MyHenco.com](https://www.henco.com)





Type: VKPK

NEW*
PRODUCT



Straight entry piece Press black
Voeding voor verdeler - pers - zwart
Départ collecteur
Eingang für Verteiler

Article number	Bag / Box	Type
VKPK-20	1 pc / 80 pc	Ø20
VKPK-26	1 pc / 70 pc	Ø26
VKPK-32*		Ø32

*packaging quantities TBD

Type: VKPK90-D

NEW*
PRODUCT



Bend entry piece down 90° - Press black
Voeding verdeler bocht 90° graden toevoer boven - pers - zwart
Départ dessous pour collecteur coude 90° - à sertir
Eingang für Verteiler Winkel 90° nieder - press

Article number	Bag / Box	Type
VKPK90-20-D	10 pc / 70 pc	20-90° down
VKPK90-26-D	10 pc / 50 pc	26-90° down

Type: VKPK90-U

NEW*
PRODUCT



Bend entry piece up 90° - Press black
Voeding verdeler bocht 90° graden toevoer onder - pers
Départ par dessus pour collecteur coude 90° - à sertir
Eingang für Verteiler Winkel 90° oben - press

Article number	Bag / Box	Type
VKPK90-20-U	10 pc / 70	20-90° up
VKPK90-26-U	10 pc / 50	26-90° up

Type: ENDCAP-EK-BLACK

NEW*
PRODUCT



Stop end eurocone for manifold
Eindstop euroconus voor verdeler
Bouchon eurocone pour collecteur
Endkappe Eurokonus für Verteiler

Article number	Bag / Box	Type
ENDCAP-EK05-BLACK	10 pc / 200 pc	3/4"

Type: 19PK



Press fit with swivel to eurocone
Perskoppeling met wartel en euroconus aansluiting
Raccord à sertir avec écrou à visser eurocone
Pressfitting mit Drehbar und Eurokonus

Article number	Bag / Box	Type
19PK-1605	10 pc / 80 pc	16x3/4" EK
19PK-2005	10 pc / 80 pc	20x3/4" EK



Henco Manifolds

Henco Full Flow Manifold

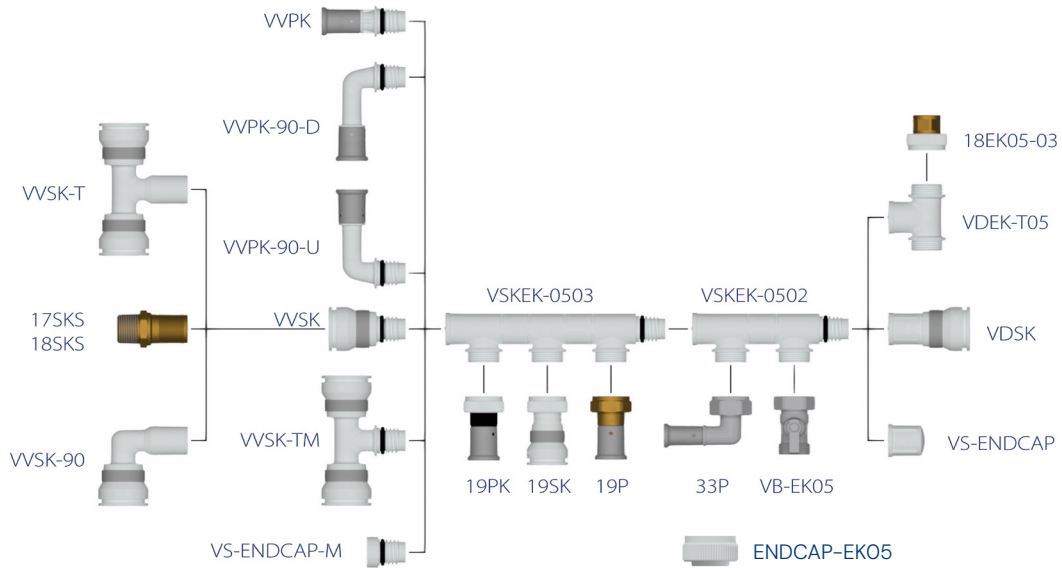

Type: VSKEK-0502



2-group extension or body for manifold, 2 eurocone connections 3/4"
2-groeps verlengstuk of basis voor verdeler, 2 euroconus-aansluitingen 3/4"
2-groupes complément ou base collecteur, 2 sorties eurocone 3/4"
2-gruppiges Erweiterung oder Basiskörper für Verteiler, 2 Eurokonus-Anschlüssen 3/4"

Article number	Bag / Box	Type
VSKEK-0502	10 pc / 30 pc	2x3/4"

Type: VSKEK-0503



3-group extension or body for manifold, 3 eurocone connections 3/4"
3-groeps verlengstuk of basis voor verdeler, 3 euroconus-aansluitingen 3/4"
3-groupes complément ou base collecteur, 3 sorties eurocone 3/4"
3-gruppiges Erweiterung oder Basiskörper für Verteiler, 3 Eurokonus-Anschlüssen 3/4"

Article number	Bag / Box	Type
VSKEK-0503	10 pc / 30 pc	3x3/4"

Type: VSKEK-ISO

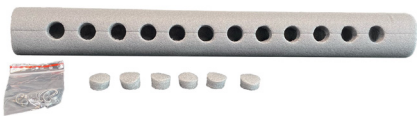

Insulation for Full Flow Manifold
Isolatie voor Full Flow Manifold verdeler
Isolation du collecteur Full Flow Manifold
Isolierung für Full Flow Manifold

Article number	Bag / Box	Type
VSKEK-ISO-12	1 pc / 50 pc	2 - 12 outlets

Type: VKEK-B05



Bracket for Full Flow Manifold
Beugel voor Full Flow Manifold
Double support pour Ful Flow collecteurs
Halter für Full Flow Verteiler

Article number	Bag / Box	Type
VKEK-B05	1 pc / 25 pc	B05





Type: 19SK



Push fitting with eurocone connection
 Steekkoppeling met euroconus-aansluiting
 Raccord push fit avec eurocone
 Steckkupplung mit Eurokonus

Article number	Bag / Box	Type
19SK-1505	10 pc / 80 pc	15x3/4" EK
19SK-1605	10 pc / 80 pc	16x3/4" EK
19SK-2005	10 pc / 80 pc	20x3/4" EK

Not suited for embedding in floors and walls

Type: 26SK



Push fitting with swivel and flat sealing
 Steekkoppeling met wartel en vlakke dichting
 Raccord push fit avec raccord écrou étanchéité plate
 Steckkupplung mit Drehbar und flach Versiegelung

Article number	Bag / Box	Type
26SK-1605	10 pc / 80 pc	16x3/4
26SK-2005	10 pc / 80 pc	20x3/4

TILL EXHAUSTION OF STOCK

Type: VVSK



Straight entry piece
 Voeding voor verdeler
 Départ collecteur
 Eingang für Verteiler

Article number	Bag / Box	Type
VVSK-20	10 pc / 80 pc	20
VVSK-26	10 pc / 70 pc	26

Type: VVSK-TM



T-piece for supply for Vision manifold
 Aanvoer T-stuk voor Vision manifold
 Départ pièce en T collecteur Vision
 T-Stück für Vorlauf für Vision Verteiler

Article number	Bag / Box	Type
VVSK-T20M20	10 pc / 30 pc	20-20
VVSK-T26M26	5 pc / 20 pc	26-26

Type: 17SKS (CW617N)



Straight nipple male
 Puntstuk
 Raccord droit mâle
 Übergangsfitting AG

Article number	Bag / Box	Type
17SKS-2004	5 pc / 150 pc	20x1/2"
17SKS-2005	5 pc / 150 pc	20x3/4"
17SKS-2604	5 pc / 100 pc	26x1/2"
17SKS-2605	5 pc / 100 pc	26x3/4"

Applicable with Henco Vision fittings & Full Flow Manifold



Henco Manifolds

Henco Full Flow Manifold

Type: 18SKS (CW617N)



Straight nipple female
Recht aansluitstuk binnendraad
Raccord droit femelle
Übergangsfitting IG

Article number	Bag / Box	Type
18SKS-2004	5 pc / 150 pc	20x1/2"
18SKS-2005	5 pc / 100 pc	20x3/4"
18SKS-2604	5 pc / 100 pc	26x1/2"
18SKS-2605	5 pc / 80 pc	26x3/4"

Applicable with Henco Vision fittings & Full Flow Manifold

Type: VVSK-90



Elbow 90° for manifold
Knie 90° voor verdeler
Coude 90° pour collecteur
Winkel 90° für Verteiler

Article number	Bag / Box	Type
VVSK-20-90	10 pc / 70 pc	20-90
VVSK-26-90	10 pc / 50 pc	26-90

Type: VVSK-T



T-piece for manifold
T-stuk voor verdeler
Pièce en T pour collecteur
T-Stück für Verteiler

Article number	Bag / Box	Type
VVSK-T202020	10 pc / 40 pc	20-20-20

Type: VS-ENDCAP



Stop end female for manifold
Eindstop binnendraad voor verdeler
Bouchon femelle pour collecteur
Endkappe IG für Verteiler

Article number	Bag / Box	Type
VS-ENDCAP	10 pc / 180 pc	F

Type: 18EK05



Connection for synthetic manifold 3/8"
Aansluiting voor kunststof verdeler 3/8"
Raccord à visser eurocone 3/8"
Verbindung für Verteiler kunststoff 3/8"

Article number	Bag / Box	Type
18EK05-03	2 pc / 200 pc	EKx3/8"



Type: VDEK-T05



T-connector for manifold
T-aansluitstuk voor Verdeler
Raccord en T pour collecteur - 2x eurocone
T-Stück für Verlauf - 2x Eurokonus

Article number	Bag / Box	Type
VDEK-T05	10 pc / 50 pc	2x EK

Type: VS-ENDCAP-M



Stop end male for manifold
Eindstop buitendraad voor verdeler
Bouchon mâle pour collecteur
Endkappe AG für Verteiler

Article number	Bag / Box	Type
VS-ENDCAP-M	10 pc / 150 pc	M

Type: ENDCAP-EK



Stop end eurocone for manifold
Eindstop euroconus voor verdeler
Bouchon eurocone pour collecteur
Endkappe Eurokonus für Verteiler

Article number	Bag / Box	Type
ENDCAP-EK05	10 pc / 200 pc	3/4"

Type: VDSK



Straight female adapter for manifold or manifold extension
Doorverbinder voor montage op verdeler of verlengstuk
Manchon pour bout de collecteur
Ausgang für Verteiler

Article number	Bag / Box	Type
VDSK-20	10 pc / 80 pc	20
VDSK-26	10 pc / 60 pc	26

Type: SK-STOPCLIP



Reusable stop and clip for push fit connection
Herbruikbare stop en clip passend in een steekkoppeling
Bouchon et clip réutilisables pour connection push fit
Stopfen und clip für Steckanschluss, wieder verwendbar

Article number	Bag / Box	Type
SK-STOPCLIP16	10 pc / 120 pc	16
SK-STOPCLIP20	10 pc / 100 pc	20
SK-STOPCLIP26	10 pc / 80 pc	26



Henco Manifolds

Henco Full Flow Manifold

1 Type: VVPK



Straight entry piece - Press
Voeding voor verdeler - Pers
Arrivée pour collecteur - à sertir
Eingang für verteiler - Press

Article number	Bag / Box	Type
VVPK-20	10 pc / 80 pc	20
VVPK-26	10 pc / 70 pc	26

7 Type: VVPK90-D



Bend entry piece down 90° - press
Voeding verdeler bocht 90° toevoer onder - pers
Départ dessous pour collecteur coude 90° - à sertir
Eingang für Verteiler Winkel 90° nieder - press Article number Bag / Box T

Article number	Bag / Box	Type
VVPK90-20-D	10 pc / 70 pc	20-90° Down
VVPK90-26-D	10 pc / 50 pc	26-90° Down

Type: VVPK90-U



Bend entry piece up 90° - press
Voeding verdeler bocht 90° graden boven - pers
Départ par dessus pour collecteur coude 90° - à sertir
Eingang für Verteiler Winkel 90° oben - press

Article number	Bag / Box	Type
VVPK90-20-U	10 pc / 70 pc	20-90° Up
VVPK90-26-U	10 pc / 50 pc	26-90° Up

Type: 19PK



Press fit with swivel to eurocone
Perskoppeling met wartel en euroconus aansluiting
Raccord à sertir avec écrou à visser eurocone
Pressfitting mit Drehbar und Eurokonus

Article number	Bag / Box	Type
19PK-1605	10 pc / 80 pc	16x3/4" EK
19PK-2005	10 pc / 80 pc	20x3/4" EK



Type: VB05-BL

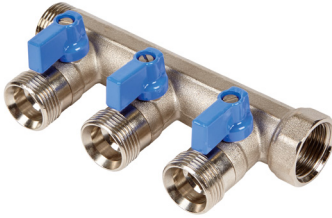

Manifold 3/4" with blue ball valves + EK connection
Verdeler 3/4" met blauwe bolkraan + EK-uitgangen
Collecteur 3/4" avec vanne à sphère bleu + EK connexion
Verteiler 3/4" mit Kugelhahnset blau + EK Verbindung

Article number	Box / Big Box	Type
VB050502-BLAUW	5 pc / 40 pc	3/4"x2xEK14,16,18 & 20 blue
VB050503-BLAUW	5 pc / 25 pc	3/4"x3xEK14,16,18 & 20 blue
VB050504-BLAUW	4 pc / 20 pc	3/4"x4xEK14,16,18 & 20 blue

Type: VB05-RO



Manifold 3/4" with red ball valve + EK connections
Verdeler 3/4" met rode bolkraan + EK aansluitingen
Collecteur 3/4" avec vanne à sphère rouge + EK connexion
Verteiler 3/4" mit Kugelhahnset rot + EK Verbindung

Article number	Box / Big Box	Type
VB050502-ROOD	5 pc / 40 pc	3/4"x2xEK14,16,18 & 20 red
VB050503-ROOD	5 pc / 25 pc	3/4"x3xEK14,16,18 & 20 red
VB050504-ROOD	4 pc / 20 pc	3/4"x4xEK14,16,18 & 20 red

Type: VB06-BL



Manifold 1" with blue ball valves + EK connection
Verdeler 1" met blauwe bolkraan + EK-uitgangen
Collecteur 1" avec vanne à sphère bleu + EK connexion
Verteiler 1" mit Kugelhahnset blau + EK Verbindung

Article number	Box / Big Box	Type
VB060502-BLAUW	5 pc / 40 pc	1"x2xEK14,16,18 & 20 blue
VB060503-BLAUW	5 pc / 25 pc	1"x3xEK14,16,18 & 20 blue
VB060504-BLAUW	4 pc / 20 pc	1"x4xEK14,16,18 & 20 blue

Type: VB06-RO

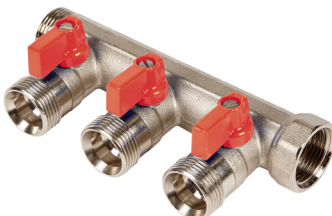

Manifold 1" with red ball valve + EK connections
Verdeler 1" met rode bolkraan + EK aansluitingen
Collecteur 1" avec vanne à sphère rouge + EK connexion
Verteiler 1" mit Kugelhahnset rot + EK Verbindung

Article number	Box / Big Box	Type
VB060502-ROOD	5 pc / 40 pc	1"x2xEK14,16,18 & 20 red
VB060503-ROOD	5 pc / 25 pc	1"x3xEK14,16,18 & 20 red
VB060504-ROOD	4 pc / 20 pc	1"x4xEK14,16,18 & 20 red



Henco Manifolds

Henco Brass Manifolds

Type: VBS05-BL



Manifold 3/4" with blue valve + EK + O-ring connection/alignment
Verdeler 3/4" met blauwe kraan + EK + O-ring aansluiting/uitlijning
Bouchon bleu pour VBS collecteur avec O-ring
Stopf blau für verteiler VBS mit O-ring

Article number	Bag / Box	Type
VBS050502-BL	1 pc / 20 pc	3/4"x2xEK14,16,18 & 20 blue
VBS050503-BL	1 pc / 15 pc	3/4"x3xEK14,16,18 & 20 blue
VBS050504-BL	1 pc / 10 pc	3/4"x4xEK14,16,18 & 20 blue

Type: VBS05-RO



Manifold 3/4" with red valve + EK + O-ring connection/alignment
Verdeler 3/4" met rode kraan + EK + O-ring aansluiting/uitlijning
Bouchon rouge pour VBS collecteur avec O-ring
Stopf rot für verteiler VBS mit O-ring

Article number	Bag / Box	Type
VBS050502-RO	1 pc / 20 pc	3/4"x2xEK14,16,18 & 20 red
VBS050503-RO	1 pc / 15 pc	3/4"x3xEK14,16,18 & 20 red
VBS050504-RO	1 pc / 10 pc	3/4"x4xEK14,16,18 & 20 red

Type: VBS05-GR



Manifold 3/4" with green valve + EK + O-ring connection/alignment
Verdeler 3/4" met groene kraan + EK + O-ring aansluiting/uitlijning
Bouchon vert pour VBS collecteur avec O-ring
Stopf grün für verteiler VBS mit O-ring

Article number	Bag	Type
VBS050502-GR	1 pc	3/4"x2xEK14,16,18 & 20 green
VBS050503-GR	1 pc	3/4"x3xEK14,16,18 & 20 green

Available on demand



Type: VBS06-BL



Manifold 1" with blue valve + EK + O-ring connection/alignment
Verdeler 1" met blauwe kraan + EK + O-ring aansluiting/uitlijning
Bouchon bleu pour VBS collecteur avec O-ring
Stopf blau für verteiler VBS mit O-ring

Article number	Bag / Box	Type
VBS060502-BL	1 pc / 20 pc	1"x2xEK14,16,18 & 20 blue
VBS060503-BL	1 pc / 15 pc	1"x3xEK14,16,18 & 20 blue
VBS060504-BL	1 pc / 10 pc	1"x4xEK14,16,18 & 20 blue

Type: VBS06-RO



Manifold 1" with red valve + EK + O-ring connection/alignment
Verdeler 1" met rode kraan + EK + O-ring aansluiting/uitlijning
Bouchon rouge pour VBS collecteur avec O-ring
Stopf rot für verteiler VBS mit O-ring

Article number	Bag / Box	Type
VBS060502-RO	1 pc / 20 pc	1"x2xEK14,16,18 & 20 red
VBS060503-RO	1 pc / 15 pc	1"x3xEK14,16,18 & 20 red
VBS060504-RO	1 pc / 10 pc	1"x4xEK14,16,18 & 20 red

Type: 6VBS



Elbow 90° female iron adapter for VBS manifold
Knie 90° voor VBS verdeler
Coude 90° femelle pour collecteur VBS
Winkel 90° IG für VBS Verteiler

Article number	Bag / Box	Type
6VBS-2005	10 pc / 50 pc	20x3/4"
6VBS-2605	5 pc / 50 pc	26x3/4"

Type: 17VBS

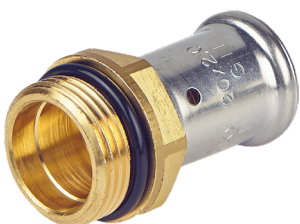

Straight adapter VBS manifold
Recht aansluitstuk VBS verdeler
Raccord droit VBS collecteur
Übergangsfitting AG VBS Verteiler

Article number	Bag / Box	Type
17VBS-2005	10 pc / 100 pc	20x3/4"
17VBS-2605	10 pc / 80 pc	26x3/4"
17VBS-2606*	10 pc / 80 pc	26x1"

*TILL EXHAUSTION OF STOCK



Henco Manifolds

Henco Brass Manifolds

Type: V-06

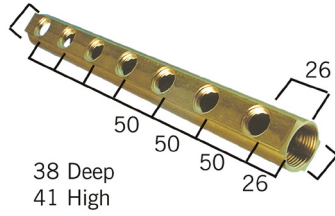

Manifold 1", 1/2" female thread, 3/8" air vent hole
Verdeler 1", 1/2" aansluitingen, 3/8" ontluchtingsopening
Collecteur 1", connexion 1/2" femelle, connexion 3/8" pour purgeur
Verteiler 1", 1/2" IG, 3/8" Loch für Entlüftung

Article number	Bag / Box	Type
V-060402	1 pc / 8 pc	1" 2x1/2" x 3/8"
V-060404	1 pc / 30 pc	1" 4x1/2" x 3/8"
V-060405	1 pc / 28 pc	1" 5x1/2" x 3/8"
V-060406	1 pc / 30 pc	1" 6x1/2" x 3/8"

TILL EXHAUSTION OF STOCK

Type: V-05-Z

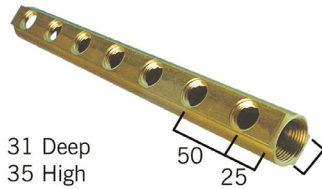

Manifold 3/4", 1/2" female thread
Verdeler 3/4", 1/2" aansluitingen
Collecteur 3/4", connexion 1/2" femelle
Verteiler 3/4", 1/2" IG

Article number	Bag / Box	Type
V-050404-Z	1 pc / 6 pc	3/4" 4x1/2"

Type: VEK-06



Manifold 1" with EK connections and one 3/8" air vent hole
Verdeler 1" met EK-aansluitingen en 3/8" ontluchtingsopening
Collecteur 1" avec des raccordements eurocone et un trou 3/8" pour purgeur
Verteiler 1" mit EK-Anschlüssen und 3/8" Loch für Entlüftung

Article number	Bag / Box	Type
VEK-060502*	1 pc / 48 pc	1" 2x3/4" x 3/8"
VEK-060503	1 pc / 32 pc	1" 3x3/4" x 3/8"
VEK-060504	1 pc / 20 pc	1" 4x3/4" x 3/8"
VEK-060505	1 pc / 21 pc	1" 5x3/4" x 3/8"
VEK-060508*	1 pc / 15 pc	1" 8x3/4" x 3/8"

**TILL EXHAUSTION OF STOCK*

Type: VEK-06-Z

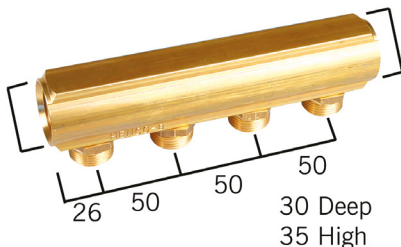

Manifold 1" with eurocone connections
Verdeler 1" met euroconus-aansluitingen
Collecteur 1" avec des raccordements eurocone
Verteiler 1" mit Eurokonus-Anschlüssen

Article number	Bag / Box	Type
VEK-060502-Z	1 pc / 48 pc	1 2X3/4
VEK-060503-Z	1 pc / 4 pc	1" 3x3/4"
VEK-060504-Z	1 pc / 4 pc	1" 4x3/4"
VEK-060505-Z	1 pc / 3 pc	1" 5x3/4"
VEK-060506-Z	1 pc / 20 pc	1" 6x3/4"
VEK-060507-Z	1 pc / 10 pc	1" 7x3/4"
VEK-060508-Z	1 pc / 10 pc	1" 8x3/4"
VEK-060509-Z	1 pc / 5 pc	1" 9x3/4"
VEK-060510-Z	1 pc / 10 pc	1" 10x3/4"



Type: VB-EK05



Ball valve, 2x eurocone connection
Bolkraan, 2x euroconus aansluiting
Vanne d'arrêt, 2x raccordement eurocone
Kugelhahn, 2x Eurokonus

Article number	Box / Big Box	Type
VB-EK05	25 pc / 100 pc	3/4" EK x 3/4" EK

Type: VB-HANDLE



Handles for VB-articles
Handvaten voor VB-artikels
Manche pour VB-article
Handgriff für VB-article

Article number	Bag / Box	Type
VB-HANDLE-RED	1 pc / 100 pc	Red
VB-HANDLE-BLUE	1 pc / 100 pc	Blue

Type: VBS-HANDLE



Handles for VBS-articles
Handvaten voor VBS-artikels
Manche pour VBS-article
Handgriff für VBS-article

Article number	Bag	Type
VBS-HANDLE-GREEN	10 pc	Green
VBS-HANDLE-BLUE	10 pc	Blue
VBS-HANDLE-RED	10 pc	Red

Type: VBS



Plug M with O-ring VBS Manifold
Blindstop M met O-ring VBS verdeler
Bouchon M pour VBS collecteur avec O-ring
Stopf M für Verteiler VBS mit O-Ring

Article number	Bag / Box	Type
VBS-05	10 pc / 250 pc	3/4" male
VBS-06	10 pc / 250 pc	1" male

Type: VBS-F



Manifold plug F for VBS manifold
Blindstop F voor VBS verdeler
Bouchon F pour VBS collecteur
Stopf F für Verteiler VBS

Article number	Bag / Box	Type
VBS-05F	10 pc / 250 pc	3/4" female
VBS-06F	10 pc / 250 pc	1" female



Henco Manifolds

Henco Manifold Accessories

Type: H-0212



Insulated manifold bracket (pairs)
Ophangbeugel dubbel met isolatie voor alle verdelers
Support double avec isolation pour tous les collecteurs
Verteiler-Halter mit Isolierung doppelt für alle Verteiler

Article number	Bag / Box	Type
H-0212	2 pc / 50 pc	3/4" - 1"

Sold per set of 2

Type: H-0212-C



Insulated manifold bracket
Ophangbeugel enkel met isolatie voor alle verdelers
Support simple avec isolation pour tous les collecteurs
Verteiler-Halter mit Isolierung einfach für alle Verteiler

Article number	Bag	Type
H-0212-C	2 pc	3/4" - 1"

Sold per set of 2

Type: VS REDUCTIE

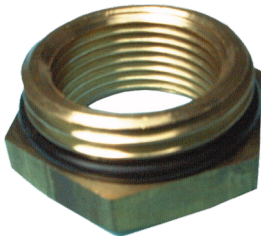

Manifold reducer with O-ring
Reductie met O-ring voor verdeler
Réduction avec O-ring pour collecteur
Reduktion für Verteiler mit O-ring

Article number	Bag / Box	Type
VS-0504	10 pc / 50 pc	3/4"x1/2"
VS-0604	10 pc / 250 pc	1"x1/2"
VS-0605	10 pc / 250 pc	1"x3/4"

Type: VS BLINDSTOP



Manifold plug
Blindstop voor verdeler
Bouchon pour collecteur
Stopfen für Verteiler

Article number	Bag / Box	Type
VS-05	10 pc / 50 pc	3/4"
VS-06	10 pc / 200 pc	1"
VS-07	10 pc / 200 pc	5/4"



Henco Valves

	<i>Page</i>
<i>Henco Inox Valves</i>	<i>124</i>
<i>Henco Brass Valves</i>	<i>125</i>



Henco Valves

Henco Inox Valves

Type: BAP-FFV



Inox ball valve with handle, press x press
 Inox bolkraan met handvat, pers x pres
 Vanne en acier inoxydable, presse x presse
 Kugelhahn aus Edelstahl, Press x Press

Article number	Bag / Box	Type
BAP-FFV1616	1 pc / 25 pc	16x16
BAP-FFV2020	1 pc / 25 pc	20x20
BAP-FFV2626	1 pc / 15 pc	26x26
BAP-FFV3232	1 pc / 15 pc	32x32

Type: BAP-FFV (fem.insert)



Inox ball valve with handle, press x female
 Inox bolkraan met handvat, pers x vrouwelijk
 Vanne en acier inoxydable, presse x femelle
 Kugelhahn aus Edelstahl, Press x IG

Article number	Bag / Box	Type
BAP-FFV1604	1 pc / 25 pc	16 x 1/2"
BAP-FFV1805	1 pc / 25 pc	18 x 3/4"
BAP-FFV2005	1 pc / 25 pc	20 x 3/4"
BAP-FFV2605	1 pc / 15 pc	26 x 3/4"
BAP-FFV2606	1 pc / 15 pc	26 x 1"
BAP-FFV3207	1 pc / 10 pc	32 x 1 1/4"

Type: BAP-FFV-Z



Inox ball valve with handle, press x swivel nut
 Inox bolkraan met handvat, pers x wartelmoer
 Vanne en acier inoxydable, presse x écrou
 Kugelhahn aus Edelstahl, Press x Anschlussverschraubung

Article number	Bag / Box	Type
BAP-FFV16Z05	1 pc / 25 pc	16x3/4"
BAP-FFV20Z05	1 pc / 25 pc	20x3/4"
BAP-FFV26Z05	1 pc / 25 pc	26x3/4"
BAP-FFV26Z06	1 pc / 15 pc	26x1"
BAP-FFV32Z06	1 pc / 15 pc	32 x 1"

Type: BAP-FFV-EK



Inox ball valve with handle, press x EK
 Inox bolkraan met handvat, pers x EK
 Vanne en acier inoxydable, presse x eurocone
 Kugelhahn aus Edelstahl, Press x Eurokonus

Article number	Bag / Box	Type
BAP-FFV1605EK	1 pc / 25 pc	16x3/4" EK
BAP-FFV2005EK	1 pc / 25 pc	20x3/4" EK
BAP-FFV2605EK	1 pc / 15 pc	26x3/4" EK



Type: BAP-H

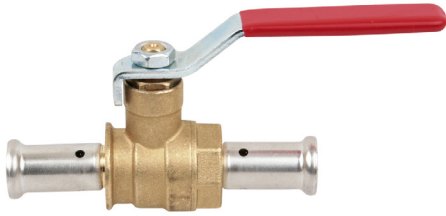

Ball valve with handle, 2x pressfitting
Bolkraan met handvat, 2x perskoppeling
Vanne d'arrêt à sertir, 2x raccord à sertir
Kugelhahnset mit Handgriff, 2x Pressfitting

Article number	Box / Big Box	Type
BAP-H1616	8 pc / 56 pc	16x16
BAP-H2020	8 pc / 56 pc	20x20
BAP-H2626	8 pc / 48 pc	26x26
BAP-H3232	5 pc / 25 pc	32x32

Type: BAP-SV



Stopvalve DN10, 2x pressfitting
Stopbolkraan DN10, 2x perskoppeling
Vanne d'arrêt DN10, 2x raccord à sertir
Kugelhahnset mit Handgriff, 2x Pressfitting

Article number	Bag / Box	Type
BAP-SV1610S	10 pc / 100 pc	16 x 10

Type: VB-EK05



Ball valve, 2x eurocone connection
Bolkraan, 2x euroconus aansluiting
Vanne d'arrêt, 2x raccordement eurocone
Kugelhahn, 2x Eurokonus

Article number	Box / Big Box	Type
VB-EK05	25 pc / 100 pc	3/4" EK x 3/4" EK

Type: BA-F41



Built-in Ball Valve Fastec DN15
Inbouwbolkraan Fastec DN15
Vanne à sphère Fastec DN15
Einbau Kugelhahnset Fastec DN15

Article number	Bag / Box	Type
BA-F41	1 pc / 50 pc	

TILL EXHAUSTION OF STOCK

- 1
- 2
- 3
- 4
- 5
- 6
- 7
- 8
- 9
- 10
- 11
- 12
- 13
- 14



Henco Valves

Henco Brass Valves

Type: EK15



Eurocone (3/4" F) for copper tube 15mm
Euroconus-schroefkoppeling (3/4" F) voor koperbuis 15mm
Raccord à visser eurocone (3/4" F) pour tube de cuivre 15mm
Schraubfitting Eurokonus (3/4") für Kupferrohr 15mm

Article number	Box / Big Box	Type
EK15	25 pc / 300 pc	Ø15x3/4" EK

Type: RADTH-VL



Thermostatic radiator valve head
Thermostatisch regelement met vaste vloeistofvoeler
Tête thermostat à bulbe, équipée d'un réglage de temp. limite
Thermostatkopf mit festem flüssigkeitsfühler

Article number	Box / Big Box	Type
RADTH-VL	10 pc / 150 pc	THERM

TILL EXHAUSTION OF STOCK

Type: RADNI



Nipple for H radiator block
Nippel voor H-radiatorblok
Vanne pour raccord radiateur (H&V)
Nippel für H-Anschluss

Article number	Bag / Box	Type
RADNI-0504	10 pc / 500 pc	1/2"x3/4"

Type: RAD04-100V



Radiator connector with 3/4" eurocone connections, straight
Onderblok met 3/4" euroconus-aansluitingen, recht
Raccord radiateur, droit, eurocone
Heizkörperanschluss 1/2" mit 3/4" Eurokonus-Anschlüssen, unten

Article number	Bag / Box	Type
RAD04-100V	1 pc / 10 pc	1/2"x3/4" EK

Type: BAP-SK



Ball valve with handle, 2x pushfitting
Bolkraan met handvat, 2x steekfitting
Vanne d'arrêt à pousser
Kugelhahnset mit Handgriff, 2x Pushfitting

Article number	Box	Type
BAP-SK1616	6 pc	16x16
BAP-SK2020	6 pc	20x20
BAP-SK2626	6 pc	26x26



Henco Smart Monitoring

Page

Henco Smart Monitoring

128



Henco Smart Monitoring

Henco Smart Monitoring



Type: HSM-VALVE-0505



Henco Smart Monitoring Valve
Henco Smart Monitoring Afsluitkraan
Henco Smart Monitoring Vanne
Henco Smart Monitoring Hähne

Article number	Bag / Box	Type
HSM-VALVE-0505	1 pc / 25 pc	2x EK 3/4"

Type: HSM-DETECTOR



Henco Smart Monitoring Detector
Henco Smart Monitoring Detector
Henco Smart Monitoring Detector
Henco Smart Monitoring Detektor

Article number	Bag / Box	Type
HSM-DETECTOR	1 pc / 100 pc	Detector

Type: HSM-SENSOR



Henco Smart Monitoring Sensor

Article number	Bag / Box	Type
HSM-SENSOR	1 pc / 100 pc	Sensor



Smart Monitoring System

The advanced Henco Smart Monitoring system gives you complete control of and insight into your water consumption and its environment. Whether you run a household, business or institution, this innovative system optimises efficiency, prevents waste and protects your property.



For more information visit MyHenco.com



Henco Underfloor Heating

	<i>Page</i>
<i>Underfloor Heating Systems</i>	<i>130</i>
<i>Underfloor Heating Manifolds</i>	<i>137</i>
<i>HencoLogic Wired</i>	<i>147</i>
<i>HencoLogic Wireless</i>	<i>149</i>
<i>Electric Underfloor Heating Systems</i>	<i>153</i>



Henco Underfloor Heating

Underfloor Heating Systems

Type: UFH-ISOPRO30



System plate with 30mm eps insulation - 1,12M²
 Noppenplaat met 30mm EPS isolatie - 1,12M²
 Plaque à plot avec isolation EPS de 30mm - 1,12M²
 Systemplatte mit dämmung styropor 30mm - 1,12M²

Article number	Multipack	Type
UFH-ISOPRO30	7 pc	1400x800mm - 5kPa - 28dB - R 0,75m ² K/W

Pipe Ø16, centre-to-centre: multiple 50mm hor./ver.

Type: UFH-ISOPRO11



System plate with 11mm eps insulation - 1,12M²
 Noppenplaat met 11mm EPS isolatie - 1,12M²
 Plaque à plot avec isolation EPS de 11mm - 1,12M²
 Systemplatte mit dämmung styropor 11mm - 1,12M²

Article number	Multipack	Type
UFH-ISOPRO11	13 pc	1400x800mm - 75kPa R 0,31m ² K/W

Pipe Ø16, centre-to-centre: multiple 50mm hor./ver.

Type: UFH-PRO



System plate without insulation - 1,12M²
 Noppenplaat zonder isolatie - 1,12M²
 Plaque à plot sans isolation - 1,12M²
 Systemplatte ohne dämmung - 1,12M²

Article number	Multipack	Type
UFH-PRO	20 pc	1400x800mm - 5kPa

Pipe Ø16, centre-to-centre: multiple 50mm hor./ver.

Type: UFH-CASTMAT

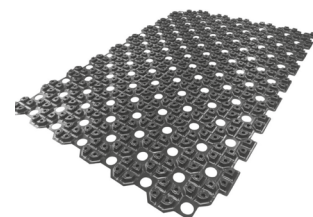

UFH castellated mat
 UFH holle noppenplaat
 UFH plaque à plot renforcée
 Systemplatte ausgef. Rohrhaltenop.

Article number	Multipack/pallet	Type
UFH-CASTMAT16	16 pc / 112 pc	Ø16, 1050 x 750 x 17 mm

Type: UFH-RAS

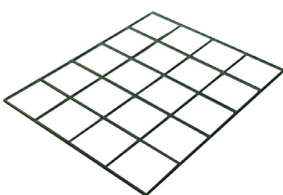

Galvanized steel mesh
 Gegalvaniseerde stalen draadmat
 Treillis en acier galvanisé
 Trägermatte aus Eisen verzinkt

Article number	Multipack	Type
UFH-RAS10	10 pc	2,52 m ² - grid 100x100mm
UFH-RAS15	10 pc	2,52 m ² - grid 150x150mm
UFH-RAS20	10 pc	2,4 m ² - grid 200x200mm



Type: UFH-RAS-RB3

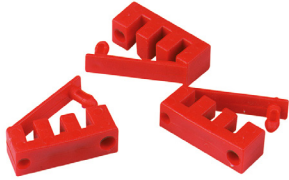

Connection clip for steel mesh
Verbindingsclip voor stalen draadmatten
Clip de fixation pour treillis
Verbinder für Trägermatte

Article number	Bag	Type
UFH-RAS-RB3	30 pc	RB

Type: UFH-RAS-BIND15

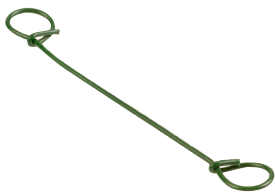

UFH-RAS-VLE
p.176

Steel strand, plasticized, to connect pipe on steel mesh
Stalen vlechtdraad, geplastificeerd, om buis op draadmat te binden
Fil de tressage métallique, plastifié, pour fixer tube sur treillis
Stahldraht, plastifiziert, für Befestigung der Rohre auf Trägermatte

Article number	Multipack	Type
UFH-RAS-BIND15A	250 pc	160 mm
UFH-RAS-BIND15B	2500 pc	160 mm

Type: UFH-RAS-CLIP



Synthetic clip for steel mesh
Kunststofclip voor draadmat
Attache en plastique pour treillis
Rohrclip für Trägermatte

Article number	Bag	Type
UFH-RAS-CLIP16	200 pc	Ø16
UFH-RAS-CLIP18	200 pc	Ø18
UFH-RAS-CLIP20*	200 pc	Ø20

**TILL EXHAUSTION OF STOCK*

Type: UFH-TACK-KLS

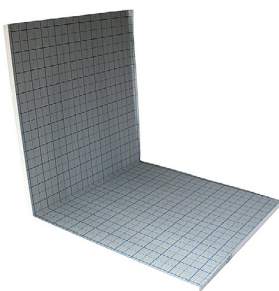

Tacker sheet with EPS insulation, foil with 100 x 100 mm grid marking and overlap - 2M²

Tacker klapset met EPS isolatie voorzien van folie met raster 100 x 100 mm en overlap - 2M²

Plaque tacker en isolation EPS, film avec trame 100 x 100 mm - 2M²

Verbundplatte aus Styropordämmung mit Folie Masche 100 x 100 mm und Überschneidung - 2M²

Article number	Multipack	Type
UFH-TACK-KLS20	5 pc	1000x2000x20mm - 4kPa - 28dB R 0,44
UFH-TACK-KLS25	5 pc	1000x2000x25mm - 4kPa - 28dB R 0,56
UFH-TACK-KLS30	5 pc	1000x2000x30mm - 4kPa - 29dB R 0,67
UFH-TACK-KLS40	5 pc	1000x2000x40mm - 4kPa - 30dB R 0,89

Type: UFH-TACK-38K



UFH-TACK
p.176

Tacker clip, 38 mm
Tackernagel, 38 mm
Agrafe tacker, 38 mm
Tackernadel, 38 mm

Article number	Box / Big Box	Type
UFH-TACK-38K	300 pc / 6000 pc	38mm

TILL EXHAUSTION OF STOCK

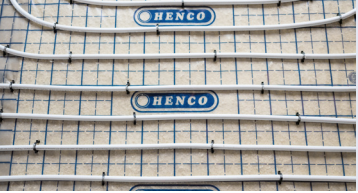

Henco Underfloor Heating

Underfloor Heating Systems

Type: UFH-TACK-40



UFH-TACK
p.176

Tacker clip, 40 mm
Tackernagel, 40 mm
Agrafe tacker, 40 mm
Tackernadel, 40 mm

Article number	Box / Big Box	Type
UFH-TACK-40	300 pc / 8400 pc	40mm

Type: UFH-TACK-60



UFH-TACK
p. 176

Tacker clip, 60 mm
Tackernagel, 60 mm
Agrafe tacker, 60 mm
Tackernadel, 60 mm

Article number	Box / Big Box	Type
UFH-TACK-60	300 pc / 6000 pc	60mm

Type: UFH-SCOTCH-66



Adhesive tape
Kleefband
Ruban adhésif
Klebeband

Article number	Box	Type
UFH-SCOTCH-66	48 pc	66 m

Type: UFH-DRY-F

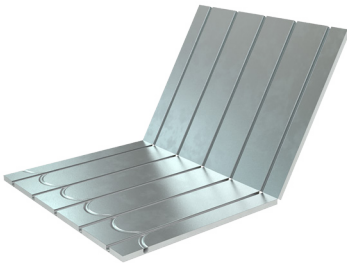

Secor Panel
Secor Paneel
Panneau Secor
Secor-Platte

Article number	Pallet	Type
UFH-DRY-1617-150F	10 pc	1177 x 750 x 17 - 150mm - 300 kPa - 0,27m ² K/W
UFH-DRY-1617-200F*	10 pc	1177 x 800 x 17 - 200mm - 300 kPa - 0,24m ² K/W
UFH-DRY-1625-100F	10 pc	1177 x 800 x 25 - 100mm - 300 kPa - 0,53m ² K/W
UFH-DRY-1625-150F	10 pc	1177 x 750 x 25 - 150mm - 300 kPa - 0,60m ² K/W
UFH-DRY-1625-200F*	10 pc	1177 x 800 x 25 - 200mm - 300 kPa - 0,61m ² K/W
UFH-DRY-1630-150F	10 pc	1177 x 750 x 30 - 150mm - 300 kPa - 0,75m ² K/W

**TILL EXHAUSTION OF STOCK*

Type: UFH-DRY-FTAPE



SECOR Aluminium tape 50mmx25m
SECOR Alu kleefband 50mmx25m
SECOR Bande adhésive aluminium 50mmx25m
SECOR ALU Klebeband 50mmx25m

Article number	Box	Type
UFH-DRY-FTAPE	36 pc	25m x 50mm



Type: UFH-DRY-NF



XPS Panel
XPS Paneel
Panneau XPS
XPS-Platte

Article number	Box	Type
UFH-DRY-1625-100NF	10 pc	1200 x 600 x 25 mm - hoh 100 mm
UFH-DRY-1625-150NF	10 pc	1200 x 600 x 25 mm - hoh 150 mm

TILL EXHAUSTION OF STOCK

Type: UFH-DRY-C

NEW*
PRODUCT



XPS panel with milling, supply pipe and aluminium top layer
XPS paneel met frezing, aanvoerleiding en aluminium toplaag
Panneau XPS avec fraisage, conduite d'alimentation et couche supérieure en aluminium
XPS-Platte mit Fräsung, Zuleitung und Aluminiumschicht

Article number	Pallet	Type
UFH-DRY-1625-100C*	10	1200x600x25mm - CTC100 - 0,72M ²
UFH-DRY-1625-150C*	10	1200x600x25mm - CTC150 - 0,72M ²

*AVAILABILITY TBD

Type: UFH-P18-GP18



Gypsum fibreboard 18mm, round milling for RENO12 system
Gipsvezelplaat 18mm, ronde frezing voor Reno12 Systeem
Plaques en fibro-plâtre 18mm, avec fraisage circul. pour le syst. reno12
Gipsfaserplatte 18mm, runde fräsung für das reno12 system

Article number	Multipack	Type
UFH-P18-GP18	1 pc	1000 x 600 x 18mm

Type: UFH-P18-GP18V



Gypsum fibreboard 18mm, vertical milling for RENO12 system
Gipsvezelplaat 18mm, verticale frezing voor Reno12 Systeem
Plaques en fibro-plâtre 18mm, pour le système reno12
Gipsfaserplatte 18mm, vertikale fräsung für das reno12 system

Article number	Multipack	Type
UFH-P18-GP18V	1 pc	1000 x 600 x 18mm

Type: UFH-P18-GP10



Gypsum fibreboard 10mm, flat for RENO12 system
Gipsvezelplaat 10mm, vlak voor Reno12 Systeem
Gipsfaserplatte 18mm, flach für das reno12 system

Article number	Multipack	Type
UFH-P18-GP10	1 pc	1500 x 1000 x 10mm



Henco Underfloor Heating

Underfloor Heating Systems

Type: UFH-P18-WN



Mesh for Reno12 system
 Wapeningsnet voor Reno12 Systeem
 Treillis d'armature pour le système reno12
 Betonstahlmatte für das reno12 system

Article number	Coil	Type
UFH-P18-WN	1 m	1 x 50m

TILL EXHAUSTION OF STOCK

Type: UFH-ISODRY-25



Insulation system board for dry system - 0,5M²
 Isolatieplaat voor droog systeem - 0,5M²
 Panneau d'isolation pour système sec - 0,5M²
 Systemplatte für trockenbau - 0,5M²

Article number	Multipack	Type
UFH-ISODRY-25	20 pc	1000x500x25mm

TILL EXHAUSTION OF STOCK

Type: UFH-DRY-GP100

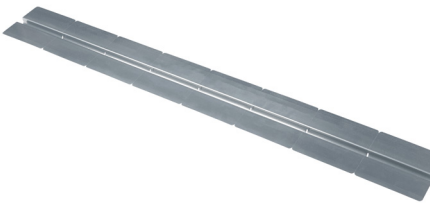

Heat diffusion profile for dry system
 Stralingsprofiel voor droog systeem
 Profil de diffusion pour système sec
 Wärmeleitlamelle für Trockenbau

Article number	Box	Type
UFH-DRY-GP100/2	50 pc	997x120x0,4mm - Ø16

TILL EXHAUSTION OF STOCK

Type: UFH-UP-M



Clip rail with adhesive strip, centres 50 mm
 U-profiel met kleefband, verlegafstand 50 mm
 Profil-U avec bande adhésif, distance de pose 50 mm
 Kunststoffclip-Schiene klebfertig für Rohr, Verlegung 50 mm

Article number	Multipack	Type
UFH-UP-14M1	100 pc	Ø14 - AS 25 mm- 1000 mm
UFH-UP-16M1	100 pc	Ø16 - AS 50 mm- 1000 mm

Type: UFH-UP

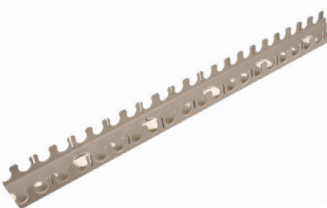

Clip rail with adhesive strip, centres 50 mm
 U-profiel met kleefband, verlegafstand 50 mm
 Profil-U avec bande adhésif, distance de pose 50 mm
 Kunststoffclip-Schiene klebfertig für Rohr, Verlegung 50 mm

Article number	Multipack	Type
UFH-UP-12	20 pc	Ø12 - AS 25 mm- 2000 mm
UFH-UP-16	40 pc	Ø16 - AS 50 mm- 2500 mm



Type: UFH-UP-CUP

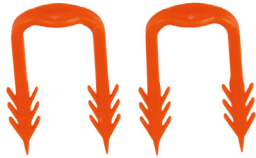

Staple for clip rail
Clip voor U-profielen
Agrafe pour profil-U
Nadel für Schienen

Article number	Bag	Type
UFH-UP-CUP50	500	50 mm

Type: UFH-FOIL

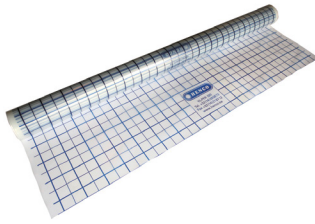

PE film, transparant, with blue grid marking 50 x 50 mm
PE-folie, transparant, blauwe rastermarkering 50 x 50 mm
Film en PE, transparent avec marquage 50 x 50 mm en bleu
Polyethylen-Schutzfolie, transparent, Markierung Blau 50x50mm

Article number	Coil	Type
UFH-FOIL50	1 pc	50X50mm 50m ²
UFH-FOIL90	1 pc	50X50mm 90m ²

Type: UFH-FOIL-N



PE film, neutral - 100M²
PE-folie, neutraal - 100M²
Film en PE, neutre - 100M²
Polyethylen-schutzfolie, neutral - 100M²

Article number	Coil	Type
UFH-FOIL-N	1 pc	50 m x 2 m - 0,2 mm

Type: UFH-FOIL-ALU



Pe-film, reflecting alu - 50M²
PE-folie, met PE-flap en alu reflectie - 50M²
Film en pe avec réflexion alu - 50M²
Polyethylen-schutzfolie, reflektion alu - 50M²

Article number	Coil	Type
UFH-FOIL-ALU	1 pc	50 m x 1 m - 3,0 mm

Type: UFH-FOIL-CLIP25



Clip for Film
Dampfolienagel
Agrafe pour film PE
Foliendübel

Article number	Bag	Type
UFH-FOIL-CLIP25	100 pc	25mm

Type: UFH-PLUG80



Plug, shaft length 80 mm, Ø8 mm
Montageplug, schachtlengte 80 mm, Ø8 mm
Cheville de montage, longueur 80 mm, Ø8 mm
Niederhaltedübel, Bohrer Ø 8 mm, Schaftlänge 80 mm

Article number	Bag	Type
UFH-PLUG80	100 pc	80 mm, Ø8 mm



Henco Underfloor Heating

Underfloor Heating Systems

Type: UFH-ISOBOARD-S



PE edge isolation with lapping strip and adhesive strip
 Randisolatie uit PE-schuim met flap en kleefstroken
 Isolation périphérique en PE avec rabat et bande adhésive
 Randdämmstreifen aus PE mit Abrisskante und Klebestreifen

Article number	Coil	Type
UFH-ISOBOARD-S	25 m	152 x 8 mm

Type: UFH-ISOBOARD-GVNL



PE edge iso. with lapping and adhesive strip for liquid floors
 Randiso. voor gietvloeren uit PE-schuim met flap en kleefstroken
 Iso. périphérique en PE avec rabat et bande adhésif, sols coulés
 Randdämmstreifen aus PE mit Abrisskante und Klebestreifen, Gussböden

Article number	Coil	Type
UFH-ISOBOARD-GVNL	50 m	100 mm x 8 mm

Type: UFH-ISOBOARD-GV



PE edge iso. with lapping and adhesive strip for anhydrite screed
 Randiso. voor anhydriet chape uit PE-schuim met flap en kleefstroken
 Iso. périphérique en PE avec rabat et bande adhésif, chape anhydrite
 Randdämmstreifen PE mit Abrisskante und Klebestreifen, Anhydrites-trisch

Article number	Coil	Type
UFH-ISOBOARD-GV	25 m	150 mm x 8 mm

Type: UFH-DH40



Protection sleeve for expansion joint
 Voegdoorganghuls
 Gaine de protection pour joint de dilatation
 Schutzrohre für Dehnungsfugen

Article number	Box	Type
UFH-DH40	100 pc	400 mm

Type: UFH-BEND



Bend guide for pipe
 Geleidingsbocht voor buis
 Courbe pour tube
 Rohrführungsbogen

Article number	Bag / Box	Type
UFH-BEND1218	50 pc / 400 pc	Ø 12 – 18 mm
UFH-BEND20	50 pc / 100 pc	Ø 20 mm

Type: UFH-ADN10



Additive for screed – 10 L (min. pipe covering 45 mm)
 Toevoegmiddel voor zandcementdekvloer – 10 L (min. buisoverdekking 45 mm)

Additif pour chape de ciment – 10 L (min. épaisseur de chape au-dessus du tube 45 mm)

Estrichzusatz – 10 L (min. Rohrüberdeckung 45 mm)

Article number	Bottle	Type
UFH-ADN10	10 LTR	

Henco Underfloor Heating

Underfloor Heating Manifolds



Type: UFH-CDP

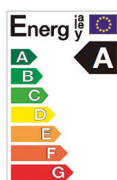
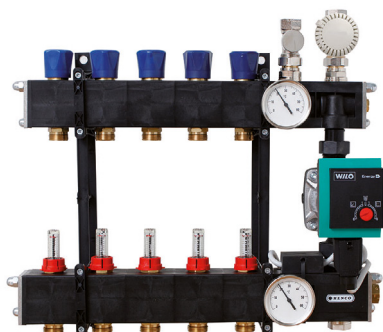

Composite manifold, adjustable with flow meter and A-pump
Composiet verdeler, regelbaar met debietmeting en A-pomp
Collecteur composite, réglable avec débitmètre et pompe label A
Verteiler Composite, regelbar mit Durchflussummengenähler und A-Pumpe

Article number	Box	Type
UFH-0405CDP01	1 pc	1/2" - 1 x 3/4"
UFH-0405CDP02	1 pc	1/2" - 2 x 3/4"
UFH-0405CDP03	1 pc	1/2" - 3 x 3/4"
UFH-0405CDP04	1 pc	1/2" - 4 x 3/4"
UFH-0405CDP05	1 pc	1/2" - 5 x 3/4"
UFH-0405CDP06	1 pc	1/2" - 6 x 3/4"
UFH-0505CDP07	1 pc	3/4" - 7 x 3/4"
UFH-0505CDP08	1 pc	3/4" - 8 x 3/4"
UFH-0505CDP09	1 pc	3/4" - 9 x 3/4"
UFH-0505CDP10	1 pc	3/4" - 10 x 3/4"
UFH-0505CDP11	1 pc	3/4" - 11 x 3/4"
UFH-0505CDP12	1 pc	3/4" - 12 x 3/4"
UFH-0505CDP13	1 pc	3/4" - 13 x 3/4"
UFH-0505CDP14	1 pc	3/4" - 14 x 3/4"
UFH-0505CDP15	1 pc	3/4" - 15 x 3/4"
UFH-0505CDP16	1 pc	3/4" - 16 x 3/4"

Type: UFH-CD



Composite manifold, adjustable with flow meter
Composiet verdeler, regelbaar met debietmeting
Collecteur composite, réglable avec débitmètre
Verteiler Composite, regelbar mit Durchflussummengenähler

Article number	Box	Type
UFH-0605CD01	1 pc	1" - 1 x 3/4"
UFH-0605CD02	1 pc	1" - 2 x 3/4"
UFH-0605CD03	1 pc	1" - 3 x 3/4"
UFH-0605CD04	1 pc	1" - 4 x 3/4"
UFH-0605CD05	1 pc	1" - 5 x 3/4"
UFH-0605CD06	1 pc	1" - 6 x 3/4"
UFH-0605CD07	1 pc	1" - 7 x 3/4"
UFH-0605CD08	1 pc	1" - 8 x 3/4"
UFH-0605CD09	1 pc	1" - 9 x 3/4"
UFH-0605CD10	1 pc	1" - 10 x 3/4"
UFH-0605CD11	1 pc	1" - 11 x 3/4"
UFH-0605CD12	1 pc	1" - 12 x 3/4"
UFH-0605CD13	1 pc	1" - 13 x 3/4"
UFH-0605CD14	1 pc	1" - 14 x 3/4"
UFH-0605CD15	1 pc	1" - 15 x 3/4"
UFH-0605CD16	1 pc	1" - 16 x 3/4"
UFH-0605CD17	1 pc	1" - 17 x 3/4"
UFH-0605CD18	1 pc	1" - 18 x 3/4"
UFH-0605CD19	1 pc	1" - 19 x 3/4"
UFH-0605CD20	1 pc	1" - 20 x 3/4"



Henco Underfloor Heating

Underfloor Heating Manifolds

Type: UFH-CP



A-pump unit for composite collector Type UFH-CD or CDP
Pompunit composiet verdeler type UFH-CD of UFH-CDP, met A-pomp
Kit pompe-A pour collecteur composite type UFH-CD ou UFH-CDP
A-Pump Unit für Composite Verteiler type UFH-CD oder UFH-CDP

Article number	Box	Type
UFH-CP	1 pc	1"

Type: UFH-SLT



Steel manifold with A-pump and LTV balancing valve
Stalen verdeler met A-pomp en LTV inregelventiel
Collecteur en acier avec pompe A et vanne d'équilibrage LTV
Stahlverteiler mit A-Pumpe und LTV-Ausgleichsventil

Article number	Box	Type
UFH-0405SLT03	1 pc	1/2" - 3 x 3/4"
UFH-0405SLT05	1 pc	1/2" - 5 x 3/4"
UFH-0405SLT06	1 pc	1/2" - 6 x 3/4"
UFH-0505SLT09	1 pc	3/4" - 9 x 3/4"
UFH-0505SLT11	1 pc	3/4" - 11 x 3/4"
UFH-0505SLT12	1 pc	3/4" - 12 x 3/4"
UFH-0505SLT14	1 pc	3/4" - 14 x 3/4"
UFH-0505SLT15	1 pc	3/4" - 15 x 3/4"
UFH-0505SLT16	1 pc	3/4" - 16 x 3/4"

Including cord, plug and maximum thermostat

TILL EXHAUSTION OF STOCK

Type: UFH-SSTE

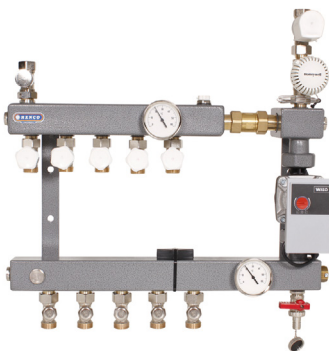

Steel collector with pump, district heating essent
Stalen verdeler met pomp, stadsverwarming essent
Collecteur en acier avec pompe, chauffage urbain essent
Verteiler Stahl mit Pump, Fernheizung essent

Article number	Box	Type
UFH-0405SSTE02-PN6	1 pc	1/2" - 2 x 3/4"
UFH-0405SSTE03-PN6	1 pc	1/2" - 3 x 3/4"
UFH-0405SSTE04-PN6	1 pc	1/2" - 4 x 3/4"
UFH-0405SSTE05-PN6	1 pc	1/2" - 5 x 3/4"
UFH-0505SSTE07-PN6	1 pc	3/4" - 7 x 3/4"

Including cord, plug and maximum thermostat

TILL EXHAUSTION OF STOCK

Henco Underfloor Heating

Underfloor Heating Manifolds



Type: UFH-MDK



Composite manifold, adjustable with flow meter, washer and air vent
Composiet verdeler, regelbaar met debietmeting, therm, vul-aftapkraan, ontluchter

Collecteur composite, réglable avec débitmètre, thermomètre, vanne d'apport et purgeur d'air

Verteiler Composite, regelbar mit Durchflussumengenzahl, therm, Entleerung-Entluft.

Article number	Box	Type
UFH-0605MDK02-03L	1 pc	1" - 2 x 3/4"
UFH-0605MDK03-03L	1 pc	1" - 3 x 3/4"
UFH-0605MDK04-03L	1 pc	1" - 4 x 3/4"
UFH-0605MDK05-03L	1 pc	1" - 5 x 3/4"
UFH-0605MDK06-03L	1 pc	1" - 6 x 3/4"
UFH-0605MDK07-03L	1 pc	1" - 7 x 3/4"
UFH-0605MDK08-03L	1 pc	1" - 8 x 3/4"
UFH-0605MDK09-03L	1 pc	1" - 9 x 3/4"
UFH-0605MDK10-03L	1 pc	1" - 10 x 3/4"
UFH-0605MDK11-03L	1 pc	1" - 11 x 3/4"
UFH-0605MDK12-03L	1 pc	1" - 12 x 3/4"

Type: UFH-MDK-PRM



Pre-mounted composite manifold, adjustable with flow meter, washer and air vent

Voorgemonteerde composiet verdeler, regelbaar met debietmeting, therm, vul-aftapkraan, ontluchter

Collecteur composite pré-assemblé, réglable avec débitmètre, thermomètre, vanne d'apport et purgeur d'air

Vormontierter verteiler Composite, regelbar mit Durchflussumengenzahl, therm, Entleerung-Entluft.

Article number	Box	Type
UFH-0605MDK02-03LPRM	1 pc	1" - 2 x 3/4"
UFH-0605MDK03-03LPRM	1 pc	1" - 3 x 3/4"
UFH-0605MDK04-03LPRM	1 pc	1" - 4 x 3/4"
UFH-0605MDK05-03LPRM	1 pc	1" - 5 x 3/4"
UFH-0605MDK06-03LPRM	1 pc	1" - 6 x 3/4"
UFH-0605MDK07-03LPRM	1 pc	1" - 7 x 3/4"
UFH-0605MDK08-03LPRM	1 pc	1" - 8 x 3/4"
UFH-0605MDK09-03LPRM	1 pc	1" - 9 x 3/4"
UFH-0605MDK10-03LPRM	1 pc	1" - 10 x 3/4"
UFH-0605MDK11-03LPRM	1 pc	1" - 11 x 3/4"
UFH-0605MDK12-03LPRM	1 pc	1" - 12 x 3/4"



Henco Underfloor Heating

Underfloor Heating Manifolds



Type: UFH-MDK-PRM-BV

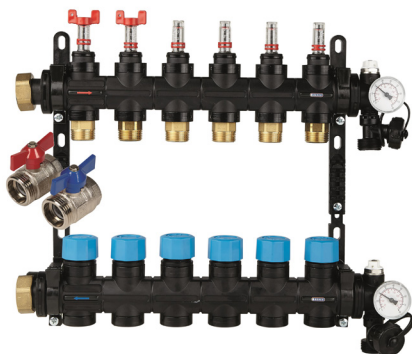

Pre-mounted composite manifold, adjustable with flow meter, washer and air vent, ball valves UFH-BM0606-VN are included

Voorgemonteerde composiet verdeler, regelbaar met debietmeting, therm, vul-aftapkraan, ontluchter, kogelkranen UFH-BM0606-VN zijn inbegrepen

Collecteur composite pré-assemblé, réglable avec débitmètre, thermomètre, vanne d'apport et purgeur d'air, les vannes sphériques UFH-BM0606-VN sont inclus

Vormontierter verteiler Composite, regelbar mit Durchflussmengenanzahl, therm, Entleerung-Entluft., Kugelhähne UFH-BM0606-VN sind enthalten

Article number	Box	Type
UFH-O605MDK02-PRM-BV	1 pc	1" - 2 x 3/4" + UFH-BM0606-VN
UFH-O605MDK03-PRM-BV	1 pc	1" - 3 x 3/4" + UFH-BM0606-VN
UFH-O605MDK04-PRM-BV	1 pc	1" - 4 x 3/4" + UFH-BM0606-VN
UFH-O605MDK05-PRM-BV	1 pc	1" - 5 x 3/4" + UFH-BM0606-VN
UFH-O605MDK06-PRM-BV	1 pc	1" - 6 x 3/4" + UFH-BM0606-VN
UFH-O605MDK07-PRM-BV	1 pc	1" - 7 x 3/4" + UFH-BM0606-VN
UFH-O605MDK08-PRM-BV	1 pc	1" - 8 x 3/4" + UFH-BM0606-VN
UFH-O605MDK09-PRM-BV	1 pc	1" - 9 x 3/4" + UFH-BM0606-VN
UFH-O605MDK10-PRM-BV	1 pc	1" - 10 x 3/4" + UFH-BM0606-VN
UFH-O605MDK11-PRM-BV	1 pc	1" - 11 x 3/4" + UFH-BM0606-VN
UFH-O605MDK12-PRM-BV	1 pc	1" - 12 x 3/4" + UFH-BM0606-VN

Type: UFH-MDK-CON



Composite connector for MDK Manifold

Composiet verbinder voor MDK Verdeler

Connecteur en composite pour collecteur MDK

Anschluss Composite für MDK-Verteiler

Article number	Bag / Box	Type
UFH-MDK-CON	1 pc / 50 pc	Straight

Type: UFH-MDK-CON90



Composite connector 90° for MDK Manifold

Composiet verbinder 90° voor MDK Verdeler

Connecteur en composite 90° pour collecteur MDK

Anschluss Composite für 90° MDK-Verteiler

Article number	Bag / Box	Type
UFH-MDK-CON90	1 pc / 25 pc	90°

Type: UFH-CMDK



Flow meter for MDK manifold

Debietmeter voor MDK verdeler

Débitmètre pour collecteur MDK

Durchflussmengenanzeiger für MDK Verteiler

Article number	Bag	Type
UFH-CMDK03	1 pc	0 - 3 l/min



Type: UFH-MDK-AO



Automatic air vent in composite for MDK manifold
Automatische ontluchter composiet voor MDK verdeler
Purgeur automatique en composite pour collecteur MDK
Automatische entlüftung in composiet für MDK verteiler

Article number	Bag	Type
UFH-MDK-AO	1 pc	3/8"

Type: UFH-MDSS

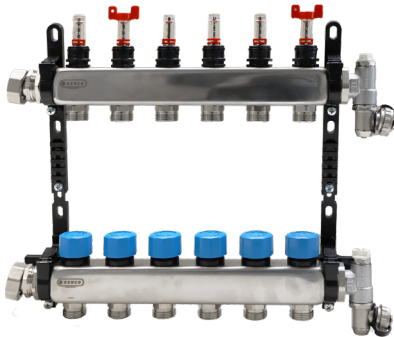

Stainless steel manifold
Roestvrij stalen verdeler
Collecteur en acier inoxydable
Edelstahlverteiler

Article number	Box	Type
UFH-0605MDSS02	1 pc	1" -2X3/4
UFH-0605MDSS03	1 pc	1" -3X3/4
UFH-0605MDSS04	1 pc	1" -4X3/4
UFH-0605MDSS05	1 pc	1" -5X3/4
UFH-0605MDSS06	1 pc	1" -6X3/4
UFH-0605MDSS07	1 pc	1" -7X3/4
UFH-0605MDSS08	1 pc	1" -8X3/4
UFH-0605MDSS09	1 pc	1" -9X3/4
UFH-0605MDSS10	1 pc	1" -10X3/4
UFH-0605MDSS11	1 pc	1" -11X3/4
UFH-0605MDSS12	1 pc	1" -12X3/4
UFH-0605MDSS13	1 pc	1" -13X3/4
UFH-0605MDSS14	1 pc	1" -14X3/4
UFH-0605MDSS15	1 pc	1" -15X3/4

Type: UFH-CMDSS



Flow meter for MDSS manifold
Debietmeter voor MDSS verdeler
Débitmètre pour collecteur MDSS
Durchflussmengenanzeiger für MDSS Verteiler

Article number	Bag	Type
UFH-CMDSS03	1 pc	0 - 5 l/min



Henco Underfloor Heating

Underfloor Heating Manifolds

Type: UFH-06-MD



Manifold brass, adjustable, with flow meters
Verdeler messing, regelbaar, met debietmeting
Collecteur en laiton, réglable, avec débitmètres
Verteiler aus Messing, regelbar, mit Durchflussmengenzähler

Article number	Box	Type
UFH-060502-MD	1 pc	1" - 2X3/4
UFH-060503-MD	1 pc	1" - 3X3/4
UFH-060504-MD	1 pc	1" - 4X3/4
UFH-060505-MD	1 pc	1" - 5X3/4
UFH-060506-MD	1 pc	1" - 6X3/4
UFH-060507-MD	1 pc	1" - 7X3/4
UFH-060508-MD	1 pc	1" - 8X3/4
UFH-060509-MD	1 pc	1" - 9X3/4
UFH-060510-MD	1 pc	1" - 10X3/4
UFH-060511-MD	1 pc	1" - 11X3/4
UFH-060512-MD	1 pc	1" - 12X3/4

Type: UFH-M-D



UFH-M-D
Debietmeter voor messing verdeler
Débitmètre pour collecteur en laiton
Durchflussmengenanzeiger für Verteiler aus Messing

Article number	Box	Type
UFH-M-D	1 pc	0-6 l/min

Type: UFH-PGKTA-K

NEW*
PRODUCT



Composite pump group – A-rated pump, with valves, thermostat and sensor
Composiet pompgroep – A-label pomp, met kranen, thermostaat en sensor
Groupe de pompage en composite – Pompe classe A, avec vannes, thermostat et sonde
Komposit-Pumpengruppe – A-Klasse-Pumpe, mit Ventilen, Thermostat und Sensor

Article number	Box	Type
UFH-PGKTA-K*	1 pc	Medium temp.: 95–60°C

**Thermostatic control head with stepless temperature adjustment from approx. 20 °C to 55 °C*

Type: UFH-PGKTA-K-T

NEW*
PRODUCT



Thermometer for UFH-PGKTA-K
Thermometer voor UFH-PGKTA-K
Thermometre pour UFH-PGKTA-K
Themometer für UFH-PGKTA-K

Article number	Box	Type
UFH-PGKTA-K-T	2 pc	



Type: UFH-C77249

NEW*
PRODUCT



Thermostatic sensor for UFH-PGKTA-K
Thermostaatkop voor UFH-PGKTA-K
Tête thermostatique pour UFH-PGKTA-K
Thermostatkopf für UFH-PGKTA-K

Article number	Box	Type
UFH-C77249	1 pc	

Type: UFH-GKT



Unit with consistent temperature control without pump
Groep met regeling voor constante temperatuur zonder pomp
Kit avec régulation de température constante sans pompe
Konstanttemperaturregelung ohne Pump

Article number	Box	Type
UFH-GKT	1 pc	1" F / 27°C - 42°C

Type: UFH-BT



1" F ball valve with 1" F swivel nut, washer and thermometer
Kogelkraan 1" F met wartelmoer 1" F, dichting en thermometer
Vanne à sphère 1" F avec écrou 1" F, joint et thermomètre
Kugelhahnset 1" IG mit Mutter 1" IG, Dichtung und Thermometer

Article number	Bag / Box	Type
UFH-BTMO606-M	1 pc / 20 pc	1" F x 1" F / 0 - 60 °

Type: UFH-B



1" F ball valve with 1" F swivel nut and washer
Kogelkraan 1" F met wartelmoer 1" F en dichting
Vanne à sphère 1" F avec écrou 1" F et joint plat
Kugelhahnset 1" IG mit Mutter 1" IG und Dichtung

Article number	Bag / Box	Type
UFH-BO606-M	1 pc / 25 pc	1" F x 1" F

Type: UFH-ESK

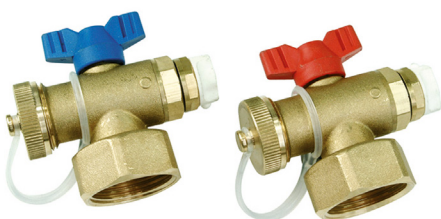

1" F end cap with nut, washer, ball valve and air vent 3/8"
Eindstuk 1" F met moer, dichting, kogelkraan en ontluftingskraan 3/8"
Bouchon terminal 1" F avec écrou, vanne à sphère, joint et purgeur 3/8"
Verteilerendstückset 1" IG mit Mutter und Dichtung, Enlüftung 3/8",
Kugelhahnset, Entleerung 1/2"

Article number	Bag / Box	Type
UFH-ESK060303-M	1 pc / 25 pc	1" F x 1/2" x 3/8"



Henco Underfloor Heating

Underfloor Heating Manifolds

Type: UFH-ESK-VN



1" F end cap with nut, washer, ball valve and air vent 3/8", nickel-plated
Eindstuk 1" F met moer, dichting, kogelkraan en ontluftingskraan 3/8", vernikkeld

Bouchon terminal 1" F avec écrou, joint et purgeur 3/8", nickelé
Versteilerendstückset 1" IG mit Mutter und Dichtung, Entlüftung 3/8", Kugelhahnset, vernickelt Article num

Article number	Bag / Box	Type
UFH-ESK060303-VN	1 pc / 10 pc	1" F x 1/2" x 3/8"

TILL EXHAUSTION OF STOCK

NEW PRODUCT

Type: UFH-WMZS-0606



Heat Meter Set, vertically mounted
Warmtemeterset, verticale montage
Kit de compteur de chaleur, montage vertical
Wärmemengenzähler-set, senkrecht

Article number	Bag / Box	Type
UFH-WMZS-0606	1 pc	1"

NEW PRODUCT

Type: UFH-WMZS-0606-WR



Heat Meter Set, horizontally mounted
Warmtemeterset, horizontale montage
Kit de compteur de chaleur, montage horizontal
Wärmemengenzähler-set, waagrecht

Article number	Bag / Box	Type
UFH-WMZS-0606-WR	1 pc	1"

NEW PRODUCT

Type: UFH-AO-MZ



Automatic air vent, without check valve
Automatische ontlufter, zonder waterslot
Purgeur automatique, sans serrure d'eau
Schnellentlüfter mit vertikaler Entlüftung, ohne Wasserabsperzung

Article number	Bag / Box	Type
UFH-AO03-MZ	1 pc / 50 pc	3/8"

Type: UFH-TM-M



Thermometer for return with EK connections
Thermometer voor terugvoer met euroconus aansluitingen
Retour thermomètre avec raccordement eurocone
Thermometer zum Anschluss Rücklauf mit Eurokonus-Anschlüssen

Article number	Bag / Box	Type
UFH-TM050-M	1 pc / 72 pc	3/4" - 3/4" EK / O

Type: UFH-BS-M



End cap with washer
Blindstop
Bouchon
Kappe mit Dichtung

Article number	Bag / Box	Type
UFH-BS05-M	1 pc / 50 pc	3/4"



Type: UFH-C260003001



Thermostatic temperature limiter 3/4"xEK
 Thermostatische temperatuurbegrenzer 3/4"xEK
 Limiteur de température thermostatique 3/4"xEK
 Thermostatischer Temperaturbegrenzer 3/4"xEK

Article number	Bag	Type
UFH-C260003001	1 pc	3/4"

Type: UFH-B-VN



1" F ball valve with 1" F swivel nut and washer , nickel-plated
 Kogelkraan 1" F met wartelmoer 1" F en dichting, vernikkeld
 Vanne à sphère 1" F avec écrou 1" F et joint, nickelé
 Kugelhahnset 1" IG mit Mutter 1" IG und Dichtung, vernickelt

Article number	Bag / Box	Type
UFH-B0606-VN	1 pc / 20 pc	1" F x 1" F / 0 - 60 °

TILL EXHAUSTION OF STOCK

Type: UFH-BMH-VN



Ball valve 90° with gasket, nickel plated (MDK and MDSS manifold), no thermometer

Kogelkraan 90° met dichting, vernikkeld (MDK en MDSS verdeler), geen thermometer

Vanne à sphère 90° et joint, nickelé (collecteur MDK et MDSS), sans thermomètre

Kugelhahnset 90°, vernickelt (Verteiler MDK und MDSS), ohne thermomètre

Article number	Box / Big Box	Type
UFH-BMH0606-VN	1 pc / 20 pc	1"x1"

Type: UFH-BMHT-VN



Ball valve 90° with gasket, nickel plated (MDK and MDSS manifold), thermometer

Kogelkraan 90° met dichting, vernikkeld (MDK en MDSS verdeler), met thermometer

Vanne à sphère 90° et joint, nickelé (collecteur MDK et MDSS), avec thermomètre

Kugelhahnset 90°, vernickelt (für Verteiler MDK und MDSS), mit thermomètre

Article number	Box / Big Box	Type
UFH-BMH0606T-VN	1 pc / 24 pc	1"x1"

Type: UFH-BM-VN



Ball valve with gasket, nickel-plated

Kogelkraan met dichting, vernikkeld

Vanne à sphère et joint, nickelé

Kugelhahnset, vernickelt

Article number	Box / Big Box	Type
UFH-BM0606-VN	1 pc / 24 pc	1"x1"



Henco Underfloor Heating

Underfloor Heating Manifolds

Type: UFH-C191800



Thermometer with immersion sleeve 0/60°C
 Thermometer met dompelhuls 0/60°C
 Thermomètre temp. 0/60°C avec bulbe
 Thermometer mit Tauchhülse 0/60°C

Article number	Bag	Type
UFH-C191800	1 pc	

Type: UFH-PG03



Underfloor heating pressure gauge 1-10 bar 3/8" male thread
 Vloerverwarming manormeter 0-10 BAR 3/8" buitendraad
 Chauffage par le sol manometre 0-10 bar 3/8" masculin
 Fußbodenheizung druckmesser 1-10 bar 3/8"ag

Article number	Box / Big Box	Type
UFH-PG03	1 pc	1 - 10 bar - 3/8" M

Type: UFH-C191974



Circulator Wilo Yonos Para RS 15-130/6-43SC(U)
 Circulator Wilo Yonos Para RS 15-130/6-43SC(U)
 Circulateur Wilo Yonos Para RS 15-130/6-43SC(U)
 Cirkulator Wilo Yonos Para RS 15-130/6-43SC(U)

Article number	Bag	Type
UFH-C191974	1 pc	1"

Type: UFH-C191976



Circulator Wilo Yonos Para RS 25-130/6-43SC(U)
 Circulator Wilo Yonos Para RS 25-130/6-43SC(U)
 Circulateur Wilo Yonos Para RS 25-130/6-43SC(U)
 Cirkulator Wilo Yonos Para RS 25-130/6-43SC(U)

Article number	Bag	Type
UFH-C191976	1 pc	1 1/2"

Type: UFH-C192071



Safety thermostat incl. wire/plug
 Maximaalthermostaat, incl. snoer/stekker
 Thermostat de sécurité, incl. fil/prise
 Maximal Thermostat incl. Snur/Stecker

Article number	Bag	Type
UFH-C192071	1 pc	



HencoLogic

Wired control unit (Heating/cooling)
 Bekabelde zoneregeling (Verwarmen/koelen)
 Régulateurs de zone cablés (Chauffage/refroidissement)
 Regelverteiler verdrahtet (Heizen/Kühlen)

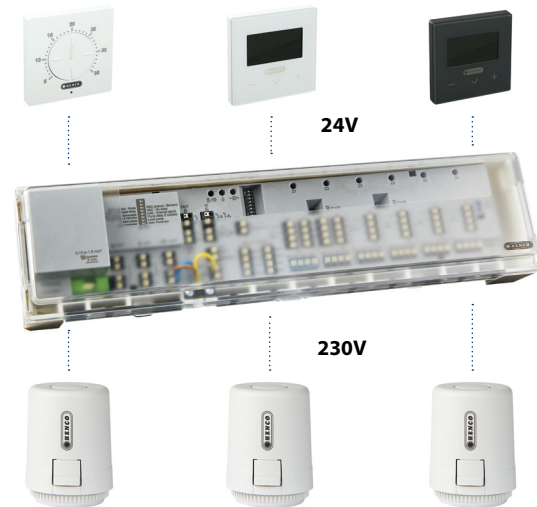

Type: CU-6ZONEB-H



Base module 6 zones heating, wired
Basisstation 6 zones verwarmen, bekabeld
Base module 6 zones chauffer, câble
Regelkleimleiste 6-zonen Heizen, Verdrahtet

Article number	Box / Big Box	Type
CU-6ZONEB-H	1 pc / 6 pc	

Type: CU-6ZONEB-HC



Base module 6 zones heating/cooling, wired
Basisstation 6 zones verwarmen/koelen, bekabeld
Base module 6 zones chauffer/refroidir, câble
Regelkleimleiste 6-zonen Heizen/Kühlen, Verdrahtet

Article number	Box / Big Box	Type
CU-6ZONEB-HC	1 pc / 6 pc	

Type: CU-6ZONE-CON



Extension module 6 zones, wired
Uitbreidingsmodule 6 zone, bekabeld
Module d'extension 6 zones, câble
Erweiterungsmodul 6-zonen Heizen/Kühlen, Verdrahtet

Article number	Box / Big Box	Type
CU-6ZONE-CON	1 pc / 6 pc	

Type: UFH-ANC



Zone valve
Zoneventiel
Vanne de zone
Zonenventil

Article number	Bag	Type
UFH-ANC-05	1 pc	2 x 3/4" - M30x1,5 - Kv 2
UFH-ANC-06	1 pc	2 x 1" - M30x1,5 - Kv 4,5

- 1
- 2
- 3
- 4
- 5
- 6
- 7
- 8
- 9
- 10
- 11
- 12
- 13
- 14

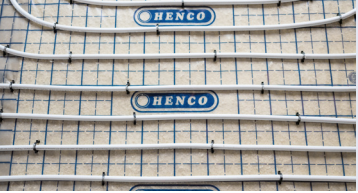

Henco Underfloor Heating

Hencologic Wired

Type: CU-ATHERMB-H



Analog thermostat heating, wired
 Analoge thermostaat verwarmen, bekabeld
 Thermostat analogue chauffer, câble
 Analog Raumthermostat Heizen, Verdrahtet

Article number	Box / Big Box	Type
CU-ATHERMB-H	1 pc / 84 pc	

Type: CU-ATHERMB-HC



Analog thermostat heating/cooling, wired
 Analoge thermostaat verwarmen/koelen, bekabeld
 Thermostat analogue chauffer/refroidir, câble
 Analog Raumthermostat Heizen/Kuhlen, Verdrahtet

Article number	Box / Big Box	Type
CU-ATHERMB-HC	1 pc / 84 pc	

Type: CU-DTHERMB-HC



Digital thermostat heating/cooling, wired
 Digitale thermostaat verwarmen/koelen, bekabeld
 Thermostat digitale chauffer/refroidir, câble
 LCD Raumthermostat Heizen/Kuhlen, Verdrahtet

Article number	Box / Big Box	Type
CU-DTHERMB-HC	1 pc / 84 pc	

Type: CU-DTHERMB-HC-B



Digital thermostat heating/cooling, wired
 Digitale thermostaat verwarmen/koelen, bekabeld
 Thermostat digitale chauffer/refroidir, câble
 LCD Raumthermostat Heizen/Kuhlen, Verdrahtet

Article number	Box / Big Box	Type
CU-DTHERMB-HC-B	1 pc / 84 pc	

Type: CU-ACT



Actuator with cable 1m
 Actuator met vaste kabel 1m
 Electrovanne avec cable 1m
 Stellantrieb Kabel 1m

Article number	Box / Big Box	Type
CU-ACT-B24V	1 pc / 100 pc	24V
CU-ACT-B230V	1 pc / 100 pc	230V



HencoLogic

Wireless control unit (Heating/cooling)

Draadloze zoneregeling (Verwarmen/koelen)

Régulateurs de zone sans fil (Chauffage/refroidissement)

Regelverteiler funk (Heizen/kühlen)

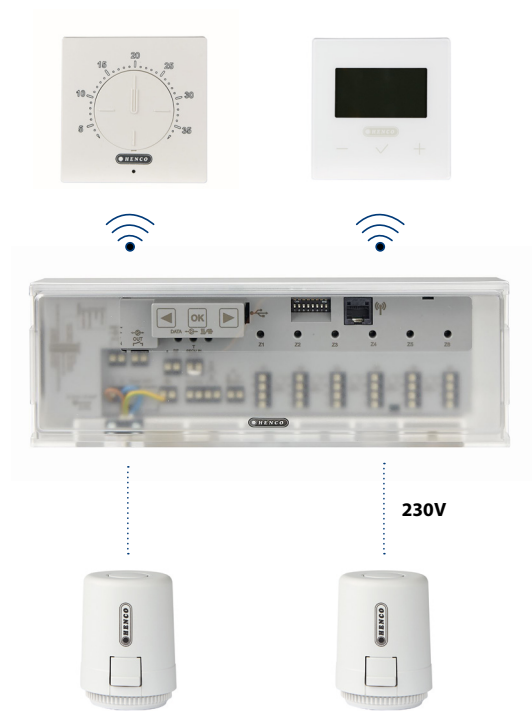

Type: CU-6ZONERF-HC



Base module 6 zones heating/cooling, wireless
Basisstation 6 zones verwarmen/koelen, draadloos
Base module 6 zones chauffer/refroidir, sans fil
Regelklemleiste 6-zonen Heizen, Funk

Article number	Box / Big Box	Type
CU-6ZONERF-HC	1 pc / 6 pc	

Type: CU-10ZONERF-HC



Base module 10 zones heating/cooling, wireless
Basisstation 10 zones verwarmen/koelen, draadloos
Base module 10 zones chauffer/refroidir, sans fil
Regelklemleiste 10-zonen Heizen/Kuhlen, Funk

Article number	Box / Big Box	Type
CU-10ZONERF-HC	1 pc / 6 pc	

Type: CU-ZONERF-HC

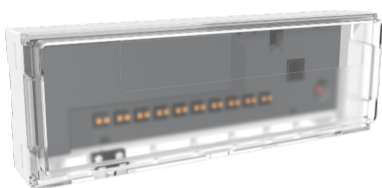

Extension module heating/cooling, wireless
Uitbreidingsmodule verwarmen/koelen, draadloos
Module d'extension chauffer/refroidir, sans fil
Erweiterungsmodul Heizen/Kuhlen, Funk

Article number	Box / Big Box	Type
CU-ZONERF-HC	1 pc / 6 pc	

- 1
- 2
- 3
- 4
- 5
- 6
- 7
- 8
- 9
- 10
- 11
- 12
- 13
- 14



Henco Underfloor Heating

Hencologic Wireless

Type: CU-ATHERMRF-HC



Analog thermostat heating/cooling, wireless
Analoge thermostaat verwarmen/koelen, draadloos
Thermostat analogue chauffer/refroidir, sans fil
Analog Raumthermostat Heizen/Kuhlen, Funk

Article number	Box / Big Box	Type
CU-ATHERMRF-HC	1 pc / 24 pc	

Type: CU-DTHERMRF-HC



Digital thermostat heating/cooling, wireless
Digitale thermostaat verwarmen/koelen, draadloos
Thermostat digitale chauffer/refroidir, sans fil
LCD Raumthermostat Heizen/Kuhlen, Funk

Article number	Box / Big Box	Type
CU-DTHERMRF-HC	1 pc / 36 pc	

Type: CU-DTHERMRF-HC-B



Digital thermostat heating/cooling, wireless
Digitale thermostaat verwarmen/koelen, draadloos
Thermostat digitale chauffer/refroidir, sans fil
LCD Raumthermostat Heizen/Kuhlen, Funk

Article number	Box / Big Box	Type
CU-DTHERMRF-HC-B	1 pc / 36 pc	

Type: CU-ANTRF



Antenna
Antenne
Antenne
Antenna

Article number	Box	Type
CU-ANTRF	35 pc	



Type: CU-REPRF



RF repeater
RF-repeater
Répéteur RF
RF-repeater

Article number	Box / Big Box	Type
CU-REPRF	1 pc / 34 pc	

Type: CU-RADTHERMRF



RF thermostatic radiator head
RF thermostatische radiator kop
Tête de radiateur thermostatique RF
RF Thermostatischer Heizkörperkopf

Article number	Box / Big Box	Type
CU-RADTHERMRF	1 pc / 48 pc	

Type: CU-WRECRF-FC



RF thermostatic radiator head
RF thermostatische radiator kop
Tête de radiateur thermostatique RF
RF Thermostatischer Heizkörperkopf

Article number	Box / Big Box	Type
CU-WRECRF-FC	1 pc / 40 pc	

Type: CU-WRECRF-LC



RF thermostatic radiator head
RF thermostatische radiator kop
Tête de radiateur thermostatique RF
RF Thermostatischer Heizkörperkopf

Article number	Box / Big Box	Type
CU-WRECRF-LC	1 pc / 40 pc	

- 1
- 2
- 3
- 4
- 5
- 6
- 7
- 8
- 9
- 10
- 11
- 12
- 13
- 14

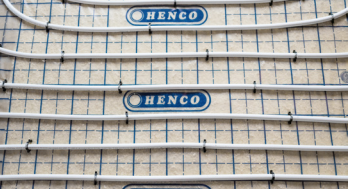

Henco Underfloor Heating

Hencologic Wireless

Type: CU-ACT



Actuator with cable 1m
Actuator met vaste kabel 1m
Electrovanne avec cable 1m
Stellantrieb Kabel 1m

Article number	Box / Big Box	Type
CU-ACT-B24V	1 pc / 100 pc	24V
CU-ACT-B230V	1 pc / 100 pc	230V

Henco Underfloor Heating

Electric Underfloor Heating Systems



Type: UFH-ELEC-KIT

NEW*
PRODUCT

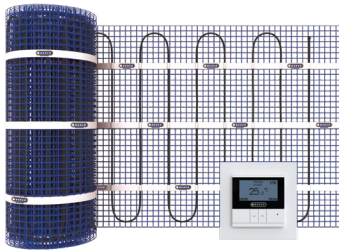

Electric underfloor heating mat incl. thermostat
Elektrische vloerverwarmingsmat incl. thermostaat
Tapis chauffant électrique au sol thermostat incl.
Elektrische fußbodenheizmatte incl. thermostat

Article number	Box / Pallet	Type
UFH-ELEC-150W-KIT	1 pc / 80 pc	Set 1m2 - 150W + WiFi thermo
UFH-ELEC-225W-KIT	1 pc / 80 pc	Set 1,5m2 - 225W + WiFi thermo
UFH-ELEC-300W-KIT	1 pc / 80 pc	Set 2m2 - 300W + WiFi thermo
UFH-ELEC-375W-KIT	1 pc / 80 pc	Set 2,5m2 - 375W + WiFi thermo
UFH-ELEC-450W-KIT	1 pc / 80 pc	Set 3m2 - 450W + WiFi thermo
UFH-ELEC-525W-KIT	1 pc / 80 pc	Set 3,5m2 - 525W + WiFi thermo
UFH-ELEC-600W-KIT	1 pc / 80 pc	Set 4m2 - 600W + WiFi thermo
UFH-ELEC-675W-KIT	1 pc / 80 pc	Set 4,5m2 - 675W + WiFi thermo
UFH-ELEC-750W-KIT	1 pc / 80 pc	Set 5m2 - 750W + WiFi thermo
UFH-ELEC-900W-KIT	1 pc / 42 pc	Set 6m2 - 900W + WiFi thermo
UFH-ELEC-1050W-KIT	1 pc / 42 pc	Set 7m2 - 1050W + WiFi thermo
UFH-ELEC-1200W-KIT	1 pc / 42 pc	Set 8m2 - 1200W + WiFi thermo
UFH-ELEC-1350W-KIT	1 pc / 42 pc	Set 9m2 - 1350W + WiFi thermo
UFH-ELEC-1500W-KIT	1 pc / 42 pc	Set 10m2 - 1500W + WiFi thermo
UFH-ELEC-1800W-KIT	1 pc / 16 pc	Set 12m2 - 1800W + WiFi thermo
UFH-ELEC-2250W-KIT	1 pc / 16 pc	Set 15m2 - 2250W + WiFi thermo
UFH-ELEC-3000W-KIT	1 pc / 16 pc	Set 20m2 - 3000W + WiFi thermo

Type: UFH-ELEC

NEW*
PRODUCT

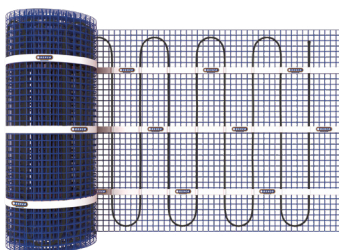

Electric underfloor heating mat
Elektrische vloerverwarmingsmat
Tapis chauffant électrique au sol
Elektrische fußbodenheizmatte

Article number	Box / Pallet	Type
UFH-ELEC-1800W	1 pc / 16 pc	12m2 - 1800W
UFH-ELEC-2250W	1 pc / 16 pc	15m2 - 2250W
UFH-ELEC-3000W	1 pc / 16 pc	20m2 - 3000W

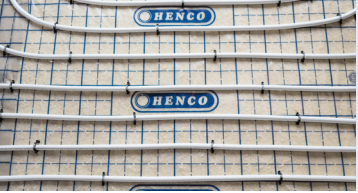

Henco Underfloor Heating

Electric Underfloor Heating Systems



Type: UFH-ELEC-THERM-W



Electric underfloor heating thermostat white
Elektrische vloerverwarming thermostaat wit
Chauffant électrique au sol thermostat blanc
Elektrische Fußbodenheizung Thermostat weiss

Article number	Box	Type
UFH-ELEC-THERM-W	1 pc	White

Type: UFH-ELEC-THERM-B



Electric underfloor heating thermostat black
Elektrische vloerverwarming thermostaat zwart
Chauffant électrique au sol thermostat noir
Elektrische Fußbodenheizung Thermostat schwarz

Article number	Box	Type
UFH-ELEC-THERM-B	1 pc	Black



Electric Underfloor Heating

Henco Electric Underfloor Heating brings heat in a completely new way. Unique asset? The advanced WiFi thermostat (2.4GHz and 5GHz) adapts to the outside temperature and calculates the heating times itself. Via the floor sensor (12K) and built-in room sensor, the room thus always remains at the desired temperature, without unnecessary energy consumption.



For more information visit [MyHenco.com](https://www.MyHenco.com)



Henco Underfloor Heating Cabinets

	<i>Page</i>
<i>Henco Underfloor Heating Cabinets</i>	<i>156</i>

Henco Underfloor Heating Cabinets

Type: UFH-CAB-I



Recessed manifold cabinet, RAL 9003
 Verdelerkast voor inbouw, RAL 9003
 Boîte à encastrer pour collecteurs, RAL 9003
 Verteilerschrank Unterputz, RAL 9003

Article number	Box	Type
UFH-CAB-I400*	1 pc	340x380x575-665x110-175mm
UFH-CAB-I455	1 pc	480x440x575-665x110-175mm
UFH-CAB-I565	1 pc	610x570x575-665x110-175mm
UFH-CAB-I715	1 pc	720x760x575-665x110-175mm
UFH-CAB-I965	1 pc	970x1010x575-665x110-175mm

**TILL EXHAUSTION OF STOCK*

Type: UFH-CAB-O



Surface mount manifold cabinet, RAL 9003
 Verdelerkast voor opbouw, RAL 9003
 Boîte à poser pour collecteurs, RAL 9003
 Verteilerschrank Aufputz, RAL 9003

Article number	Box	Type
UFH-CAB-O385	1 pc	385x385x580x120mm
UFH-CAB-O400*	1 pc	485x485x580x120mm
UFH-CAB-O615	1 pc	615x615x580x120mm
UFH-CAB-O800*	1 pc	800x720x112mm
UFH-CAB-O1015	1 pc	1015x1015x580x120mm

**TILL EXHAUSTION OF STOCK*

Type: UFH-CAB-OZ



Surface mount manifold without back
 Verdelerkast zonder rug voor opbouw
 Boîte à poser pour collecteurs sans plaque arrière
 Verteilerschrank Aufputz ohne Rückwand

Article number	Box	Type
UFH-CAB-O385Z	1 pc	385x580x120mm
UFH-CAB-O615Z	1 pc	615x580x120mm
UFH-CAB-O1015Z	1 pc	1015x580x120mm



Henco Tools

	<i>Page</i>
<i>Bending Tools</i>	<i>158</i>
<i>Cutting Tools</i>	<i>159</i>
<i>Calibration Tools</i>	<i>160</i>
<i>Pressing Tools</i>	<i>162</i>
<i>Smart Tools</i>	<i>173</i>
<i>Underfloor Heating Tools</i>	<i>176</i>



Henco Tools

Bending Tools

Type: BI



Internal bending spring
Binnenbuigveer
Ressort à plier intérieur
Biegefeder innen

Article number	Bag / Box	Type
BI-1410	1 pc / 100 pc	14x2 L=50 cm
BI-1612	1 pc / 100 pc	16x2 L=50 cm
BI-1612L	1 pc / 50 pc	16x2 L=100 cm
BI-1814	1 pc / 75 pc	18x2 L=50 cm
BI-2016	1 pc / 75 pc	20x2 L=50 cm
BI-2016L	1 pc / 25 pc	20x2 L=100 cm
BI-2620	1 pc / 25 pc	26x3 L=100 cm

Type: BA



External bending spring
Buitenbuigveer
Ressort à plier extérieur
Biegefeder aussen

Article number	Bag / Box	Type
BA-1288	1 pc / 50 pc	12x1,88 L=50 cm
BA-1410	1 pc / 50 pc	14x2 L=50 cm
BA-1612	1 pc / 50 pc	16x2 L=50 cm
BA-1814	1 pc / 50 pc	18x2 L=50 cm
BA-2016	1 pc / 50 pc	20x2 L=50 cm

Type: BM



Bending tool
Buigijzer
Cintreuse
Biegewerkzeug

Article number	Box / Big Box	Type
BM-16	1 pc / 15 pc	for Ø16
BM-18*	1 pc / NaN	for Ø18
BM-20	1 pc / 8 pc	for Ø20
BM-26	1 pc / 4 pc	for Ø26

* TILL EXHAUSTION OF STOCK

Type: BM-F



Fast bending tool
Snelbuig tool
Cintreuse rapide
Schnell Biegewerkzeug

Article number	Box / Big Box	Type
BM-16F	1 pc / 50 pc	for Ø16
BM-20F	1 pc / 40 pc	for Ø20



Type: IMPRESS



Guillotine cutter for multilayer and protection hose
Guillotineschaar voor meerlaagse en beschermsslangen
Pince guillotine pour tuyaux multicouches et de protection
Guillotinezange für Mehrschicht- und Schutzschläuche

Article number	Box / Big Box	Type
IM1426PRESS	1 pc / 36 pc	14 till 26 mm

Type: IMPRESS-N



Guillotine cutter
Guillotineschaar
Pince guillotine
Guillotinezange

Article number	Box / Big Box	Type
IM1426PRESS-N	1 pc / 36 pc	14 till 26 mm

Type: IMEMPRESS



Replacement blade for IMPRESS
Vervangmes voor IMPRESS
Lame pour IMPRESS
Ersatzmesser für IMPRESS

Article number	Bag / Box	Type
IMEM1426-PRESS	1 pc / 150 pc	FOR IM1426PRESS(-N)3

Type: IM



Wheel cutter
Buizensnijder
Coupe-tube
Rohrschneidezange

Article number	Box / Big Box	Type
IM63	1 pc / 15 pc	14 till 63 mm

Type: IMEM



Replacement blade for IM
Vervangmes voor IM
Coûteau de rechange pour IM
Ersatzmesser für IM

Article number	Bag / Box	Type
IMEM63	1 pc / 150 pc	For IM63

Type: RS



Wheel cutter
Buizensnijder
Coupe-tube
Rohrschneidezange

Article number	Box	Type
RS32	1 pc	14 till 32 mm

TILL EXHAUSTION OF STOCK



Henco Tools

Calibration Tools

Type: KS-MSET1



Set with KS-K and KS-M for Ø16, 20 and 26
 Set met KS-K en KS-M voor Ø16, 20 en 26
 Set avec KS-K et KS-M pour Ø16, 20 et 26
 Henco Set mit KS-K und KS-M für Ø16, 20 und 26

Article number	Box	Type
KS-MSET1	1 pc	Ø16, Ø20, Ø26

Type: KS-MSET3



Set with KS-K and KS-M for Ø16, 20, 26 and 32 + Presscheck
 Set met KS-K en KS-M voor Ø16, 20, 26 en 32 + Presscheck
 Set avec KS-K et KS-M pour Ø16, 20, 26 et 32 + Presscheck
 Set mit KS-K und KS-M für Ø16, 20, 26 und 32 + Presscheck

Article number	Box	Type
KS-MSET3	1 pc	Ø16, Ø20, Ø26 and Ø32 + Presscheck

Type: KS-MSET4



Set with KS-K and KS-M for Ø16, 20, 26 and 32
 Set met KS-K en KS-M voor Ø16, 20, 26 en 32
 Set avec KS-K et KS-M pour Ø16, 20, 26 et 32
 Set mit KS-K und KS-M für Ø16, 20, 26 und 32

Article number	Box	Type
KS-MSET4	1 pc	Ø16, Ø20, Ø26, Ø32

Type: KS



Kalispeed for electric drills (max. 500 rpm, clockwise only)
 Kalispeed voor accu-boormachine (max. 500 toeren, rechts draaien verplicht)
 Kalispeed pour perceuses à batterie (max. 500 tournages, obligation de tourner à droite)
 Kalispeed für Akku-Bohrmaschine (max. 500 Drehungen, rechts drehen verpflichtet)

Article number	Box	Type
KS50	1 pc	for Ø50
KS63	1 pc	for Ø63



Type: KS-M



Kalispeed, metal, for KS-K and electric drills (max. 500 rpm, clockwise only)

Kalispeed, metaal, voor KS-K en accu-boormachine (max. 500 toeren, rechts draaien verplicht)

Kalispeed, métal, pour KS-K et perceuses à batterie (max. 500 tours, obligation de tourner à droite)

Kalispeed, Metall, für KS-K und Akku-Bohrmaschine (max. 500 Drehungen, rechts drehen verpflichtet)

Article number	Box	Type
KS12M	1 pc	for Ø12
KS14M	1 pc	for Ø14
KS16M	1 pc	for Ø16
KS18M	1 pc	for Ø18
KS20M	1 pc	for Ø20
KS26M	1 pc	for Ø26
KS32M	1 pc	for Ø32
KS40M	1 pc	for Ø40

Type: KS-K



Clickhandle for KS (Kalispeed)

Klikhandvat voor KS (Kalispeed)

Manche clic pour KS (Kalispeed)

Klickgriff für KS (Kalispeed)

Article number	Box	Type
KS-K	1 pc	up to Ø63 mm

Type: KS-P



Kalispeed for Ø16, 20 and 26

Kalispeed voor Ø16, 20 en 26

Kalispeed pour Ø16, 20 et 26

Kalispeed für Ø16, 20 und 26

Article number	Box / Big Box	Type
KS-P162026	1 pc / 288 pc	for Ø16, 20 and 26 <i>Not for intensive use</i>



Henco Tools

Pressing Tools

Type: M-BA03



Kit: battery-press machine + battery + charger + case, linear drive 32 to 40 kN

Kit: accu-persmachine + accu + lader + koffer, lineaire aandrijving 32 tot 40 kN

Kit: machine à sertir + batterie + chargeur + coffret, propulsion linéaire 32 jusqu'à 40 kN

Kit: Akku-Pressmaschine, lineare Schubkraft 32 bis 40 kN

Article number	Box	Type
M-BA03	1 pc	BATTERY

Type: M-BOXBA03



Case for M-BA03

Koffer voor M-BA03

Coffre pour M-BA03

Koffer für M-BOXBA03

Article number	Box	Type
M-BOXBA03	1 pc	BOX M-BA03

Type: M-BAT03



Battery for M-BA03

Accu voor M-BA03

Batterie pour M-BA03

Akku für M-BA03

Article number	Box	Type
M-BAT03	1 pc	BATTERY

Type: M-LAD03



Charge-unit for M-BA03

Lader voor M-BA03

Chargeur pour M-BA03

Akku-Ladegerät für M-BA03

Article number	Box	Type
M-LAD03	1 pc	CHARGER

Type: M-TRANS



Main adapter for M-BA03

Adapter voor netaansluiting M-BA03

Adapteur raccordement au réseau M-BA03

Netzadapter für M-BA03

Article number	Box	Type
M-TRANS03	1 pc	ADAPTER



Type: M-BHY162026



Kit : 230V hydraulic press machine with 16, 20, 26 jaws + metal case (110 volt also available), linear drive 32 to 40 kN

Kit : Elektrisch-hydraulische persmachine + bekken 16, 20, 26 + koffer, lineaire aandrijving 32 tot 40kN

Kit: machine à sertir électro-hydraulique + pinces 16, 20, 26 + coffret, propulsion linéaire 32 jusqu'à 40 kN

Kit : Elektrohydraulische Pressmaschine + Pressbacken 16, 20, 26 + Koffer, lineare Schubkraft 32 bis 40 kN

Article number	Box	Type
M-BHY162026	1 pc	Wired

TILL EXHAUSTION OF STOCK

Type: BE



Jaws (universal)

Persbekken (universeel)

Pinces à sertir (universel)

Pressbacken (universal)

Article number	Box	Type
BE14	1 pc	BE/TH 14x2
BE16	1 pc	BE/TH 16x2
BE17	1 pc	BE/TH 17x2
BE18	1 pc	BE/TH 18x2
BE20	1 pc	BE/TH 20x2
BE26	1 pc	BE/TH 26x3
BE32	1 pc	BE 32x3
BE40	1 pc	BE 40x3,5
BE50	1 pc	BE 50x4
BE63	1 pc	BE 63x4,5

Press tool compatilby: see www.henco.be

Type: BE-UNISSET1



Set with universal jaw mounting unit and BE-H inserts BE-H Ø16, 20 en 26

Set met universele moederbek en wisselbekken BE-H Ø16, 20 en 26

Set avec pince mère universel et pinces BE-H Ø16, 20 en 26

Set mit Mutterpressbacke universal und Backen BE-H Ø16, 20 en 26

Article number	Box	Type
BE-UNISSET1	1 pc	16, 20 & 26mm

Press tool compatilby: see www.henco.be



Henco Tools

Pressing Tools

Type: BE-UNISSET2



Set with universal jaw mounting unit and BE-H inserts Ø14, 16, 18, 20, 26, and 32
 Set met universele moederbek en wisselbekken BE-H Ø14, 16, 18, 20, 26 en 32
 Set avec pince mère universel et pinces BE-H Ø14, 16, 18, 20, 26, et 32
 Set mit Mutterpressbacke universal und Backen BE-H Ø14, 16, 18, 20, 26, und 32

Article number	Box	Type
BE-UNISSET2	1 pc	14, 16, 18, 20, 26 & 32mm

Press tool compatibility: see www.henco.be

Type: BE-UNISSETMINI3



Set with jaw be-mini3 + be-h inserts ø 16, 20, 26, 32
 Set met moederbek be-mini3 en wisselbekken be-h ø 16, 20, 26 en 32
 Set avec pince mère be-mini3 + pinces be-h ø 16, 20, 26, 32
 Set mit mutterpressbacke be-mini3 + backen be-h ø 16, 20, 26, 32

Article number	Box	Type
BE-UNISSETMINI3	1 pc	16, 20, 26 & 32mm

Press tool compatibility: see www.henco.be

Type: TOOLBOX16202632



Box with KS16 20 26 32 M, BE-UNI, BE16 20 26 32 H, BI-1612, BI-2016, BA-1612, BA-2016, IM1426PRESS, SAFECUT
 Koffer met KS16 20 26 32 M, BE-UNI, BE16 20 26 32 H, BI-1612, BI-2016, BA-1612, BA-2016, IM1426PRESS, SAFECUT
 Coffre avec KS16 20 26 32 M, BE-UNI, BE16 20 26 32 H, BI-1612, BI-2016, BA-1612, BA-2016, IM1426PRESS, SAFECUT
 Koffer mit KS16 20 26 32 M, BE-UNI, BE16 20 26 32 H, BI-1612, BI-2016, BA-1612, BA-2016, IM1426PRESS, SAFECUT

Article number	Box	Type
TOOLBOX16202632	1 pc	16, 20, 26 & 32mm

Press tool compatibility: see www.henco.be

Type: TOOLBOX405063



Box with KS40M, KS50, KS63, BE40 50 63, IM63
 Koffer met KS40M, KS50, KS63, BE40 50 63, IM63
 Coffre avec KS40M, KS50, KS63, BE40 50 63, IM63
 Koffer mit KS40M, KS50, KS63, BE40 50 63, IM63

Article number	Box	Type
TOOLBOX405063	1 pc	40, 50 & 63mm

Press tool compatibility: see www.henco.be



Type: BE-UNI



Jaw mounting unit for M-BA03 and M-BHY, to be used with BE-H jaws
Moederbek voor M-BA03 en M-BHY en te gebruiken met BE-H bekken
Pince mère pour M-BA03 et M-BHY, à utiliser avec pinces BE-H
Mutterpressbacke für M-BA03 und M-BHY, zu verwenden mit BE-H Backen

Article number	Bag / Big Box	Type
BE-UNI	1 pc / 12 pc	MOTHER JAW

BE-UNI is designed to press Henco press fittings, the interchangeable dies with M- and V-profile make it possible to make the transition from other materials to Henco other than Henco branded fittings with compact measurements can cause complex manipulation

Type: BE-H



Inserts for BE-UNI, BE-MINI2, BE-MINI3, M-BH
Wisselbekken voor BE-UNI, BE-MINI2, BE-MINI3, M-BH
Pinces pour BE-UNI, BE-MINI2, BE-MINI3, M-BH
Pressbacken für BE-UNI, BE-MINI2, BE-MINI3, M-BH

Article number	Bag	Type
BE14H	1 pc	BE/TH 14X2 H
BE16H	1 pc	BE/TH 16X2 H
BE18H	1 pc	BE/TH 18X2 H
BE20H	1 pc	BE/TH 20X2 H
BE25H	1 pc	BE/TH 25X3 H
BE26H	1 pc	BE/TH 26X3 H
BE32H	1 pc	BE 32X3 H

Our warranty does not apply to other pipe systems with M or V profile

Type: BE-HC

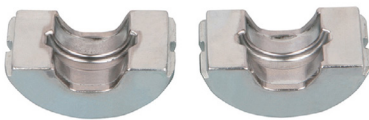

Inserts (copper) for BE-UNI, BE-MINI2, BE-MINI3, M-BH
Wisselbekken (koper) voor BE-UNI, BE-MINI2, BE-MINI3, M-BH
Pinces (cuivre) pour BE-UNI, BE-MINI2, BE-MINI3, M-BH
Pressbacken (Kupfer) für BE-UNI, BE-MINI2, BE-MINI3, M-BH

Article number	Box	Type
BE12HC	1 pc	12Cu V-profile
BE14HC	1 pc	14Cu V-profile
BE15HC	1 pc	15Cu V-profile
BE16HC	1 pc	16Cu V-profile
BE18HC	1 pc	18Cu V-profile
BE22HC	1 pc	22Cu V-profile
BE28HC	1 pc	28Cu V-profile

Our warranty does not apply to other pipe systems with M or V profile



Henco Tools

Pressing Tools

Type: BE-HM

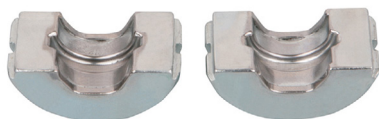

Inserts (copper) for BE-UNI, BE-MINI2, BE-MINI3, M-BH
 Wisselbekken (koper) voor BE-UNI, BE-MINI2, BE-MINI3, M-BH
 Pincés (cuivre) pour BE-UNI, BE-MINI2, BE-MINI3, M-BH
 Pressbacken (Kupfer) für BE-UNI, BE-MINI2, BE-MINI3, M-BH

Article number	Box	Type
BE12HM	1 pc	12Cu M-profile
BE15HM	1 pc	15Cu M-profile
BE18HM	1 pc	18Cu M-profile
BE22HM	1 pc	22Cu M-profile

Our warranty does not apply to other pipe systems with M or V profile

Type: BE-BOX



Metal case for 4 compression jaws
 Stalen koffer voor 4 persbekken
 Coffret en métal pour 4 pincés à sertir
 Stahlblechkasten für 4 Pressbacken

Article number	Box	Type
BE-BOX	4 pc	BOX

Type: M-BMINI3-F



Kit : compact rechargeable battery press machine with press monitoring + case + charge unit + battery 18V + full jaws TH16-20-26, linear drive ca. 19 kN

Kit: hydraulische accu-persmachine met persbewaking + koffer + lader + 1 accu 18V + volle bekken TH16-20-26, lineaire aandrijving ca. 19kN

Kit : machine à sertir hydraulique + boîte + chargeur + batterie 18V, pince TH16-20-26, propulsion linéaire ca.19 kN

Kit: Hydraulisches Akku-Presswerkzeug mit Pressdrucküberwachung + Koffer + Ladegerät + 1 Akku 18V + Pressbacken TH16-20-26, lineare Schubkraft ca. 19 kN

Article number	Box	Type
M-BMINI3-F	1 pc	Ø16-26 / 18V

Type: M-BMINI3



Kit : compact rechargeable battery press machine with press monitoring + case + charge unit + battery 18V + mother jaw + inserts TH16-20-26, linear drive ca. 19 kN

Kit: hydraulische accu-persmachine met persbewaking + koffer + lader + 1 accu 18V, lineaire aandrijving ca. 19kN + presscheck + moederbek met inserts 16/20/26

Kit : machine à sertir hydraulique + boîte + chargeur + batterie 18V + pince mère + inserts TH16-20-26, propulsion linéaire ca.19 kN

Kit: Hydraulisches Akku-Presswerkzeug mit Pressdrucküberwachung + Koffer + Ladegerät + 1 Akku 18V + Mutterpressbacke und Pressbacken TH16-20-26, lineare Schubkraft ca. 19 kN

Article number	Box	Type
M-BMINI3	1 pc	Ø16-26 / 18V



Type: M-BMINI3-S



Hydraulic press machine with battery 18V and linear drive 19kN
 Hydraulische persmachine met batterij 18V en lineaire aandrijving 19kN
 Machine à sertir hydraulique avec batterie 18V et propulsion linéaire 19kN
 Hydraulisches Akku-presswerkzeug mit Akku 18V und lineare Schubkraft 19kN

Article number	Box	Type
M-BMINI3-S	1 pc	Ø16-26 / 18V

Type: M-BATMINI3



Battery 18V for M-BMINI3
 Accu 18V voor M-BMINI3
 Batterie 18V pour M-BMINI3
 Akku 18V für M-BMINI3

Article number	Box	Type
M-BATMINI3-2.0AH	1 pc	18V / 2,0 Ah Li-ion
M-BATMINI3-5.0AH	1 pc	18V / 3,5 Ah Li-ion

Type: M-LADMINI3



Charge-unit for M-BMINI3 (-S and -F) + 5m cable
 Lader voor M-BMINI3 (-S and -F) + 5m kabel
 Chargeur pour M-BMINI3 (-S and -F) + 5m cable
 Akku-Ladegerät für M-BMINI3 (-S and -F) + 5m Kabel

Article number	Box	Type
M-LADMINI3	1 pc	CHARGER

Type: M-TRANSMINI3



Mains adapter for press machines M-BMINI3 (-S and -F) + 5m cable
 Adapter voor netaansluiting M-BMINI3 (-S and -F) + 5m kabel
 Adapteur raccordement au réseau M-BMINI3 (-S and -F) + 5m cable
 Netzadapter für M-BMINI3 (-S and -F) + 5m Kabel

Article number	Box	Type
M-TRANSMINI3	1 pc	18V / 230V

Type: M-BOXMINI3



Case for M-BMINI3
 Koffer voor M-BMINI3
 Coffret pour M-BMINI3
 Koffer für M-BMINI3

Article number	Box	Type
M-BOXMINI3	1 pc	BOX

- 1
- 2
- 3
- 4
- 5
- 6
- 7
- 8
- 9
- 10
- 11
- 12
- 13
- 14



Henco Tools

Pressing Tools

1 Type: M-BOXMINI3-F



Case for M-BMINI3-F
Koffer voor M-BMINI3-F
Coffret pour M-BMINI3-F
Koffer für M-BMINI3-F

Article number	Box	Type
M-BOXMINI3-F	1 pc	BOX

6 Type: BE-MINI3



Jaw mounting unit for press machine M-BMINI3 and to be used with BE-H jaws

Moederbek voor persmachine M-BMINI3 en te gebruiken met BE-H bekken

Pince mère pour machine à sertir M-BMINI3 et à utiliser avec pinces BE-H
Mutterpressbacke für Presswerkzeug M-BMINI3, zu verwenden mit BE-H Backen

Article number	Box	Type
BE-MINI3	1 pc	BE-MINI3

12 Type: BE-H

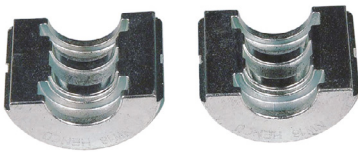

Inserts for BE-UNI, BE-MINI2, BE-MINI3, M-BH
Wisselbekken voor BE-UNI, BE-MINI2, BE-MINI3, M-BH
Pincas pour BE-UNI, BE-MINI2, BE-MINI3, M-BH
Pressbacken für BE-UNI, BE-MINI2, BE-MINI3, M-BH

Article number	Bag	Type
BE14H	1 pc	BE/TH 14X2 H
BE16H	1 pc	BE/TH 16X2 H
BE18H	1 pc	BE/TH 18X2 H
BE20H	1 pc	BE/TH 20X2 H
BE25H	1 pc	BE/TH 25X3 H
BE26H	1 pc	BE/TH 26X3 H
BE32H	1 pc	BE 32X3 H

Our warranty does not apply to other pipe systems with M or V profile

Type: BE-HC

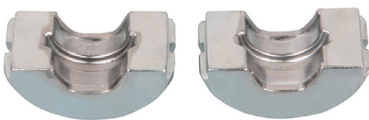

Inserts (copper) for BE-UNI, BE-MINI2, BE-MINI3, M-BH
Wisselbekken (koper) voor BE-UNI, BE-MINI2, BE-MINI3, M-BH
Pincas (cuvre) pour BE-UNI, BE-MINI2, BE-MINI3, M-BH
Pressbacken (Kupfer) für BE-UNI, BE-MINI2, BE-MINI3, M-BH

Article number	Box	Type
BE12HC	1 pc	12Cu V-profile
BE14HC	1 pc	14Cu V-profile
BE15HC	1 pc	15Cu V-profile
BE16HC	1 pc	16Cu V-profile
BE18HC	1 pc	18Cu V-profile
BE22HC	1 pc	22Cu V-profile
BE28HC	1 pc	28Cu V-profile

Our warranty does not apply to other pipe systems with M or V profile



Type: BE-HM

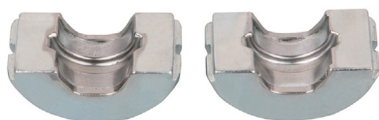

Inserts (copper) for BE-UNI, BE-MINI2, BE-MINI3, M-BH
Wisselbekken (koper) voor BE-UNI, BE-MINI2, BE-MINI3, M-BH
Pinces (cuivre) pour BE-UNI, BE-MINI2, BE-MINI3, M-BH
Pressbacken (Kupfer) für BE-UNI, BE-MINI2, BE-MINI3, M-BH

Article number	Box	Type
BE12HM	1 pc	12Cu M-profile
BE15HM	1 pc	15Cu M-profile
BE18HM	1 pc	18Cu M-profile
BE22HM	1 pc	22Cu M-profile

Our warranty does not apply to other pipe systems with M or V profile

Type: BE..-MINI3



Jaw for press machine M-BMINI3 - TH profile
Bek voor persmachine M-BMINI3 - TH profiel
Pince pour machine à sertir M-BMINI3 - Profil TH
Pressbacke für Presswerkzeuge M-BMINI3 + Profil TH

Article number	Box	Type
BE14MINI3	1 pc	BE/TH Ø14
BE16MINI3	1 pc	BE/TH Ø16
BE20MINI3	1 pc	BE/TH Ø20
BE25MINI3	1 pc	BE/TH Ø25
BE26MINI3	1 pc	BE/TH Ø26
BE32MINI3	1 pc	BE Ø32

Press tool compatibility: www.henco/downloads.be

Type: BE.V-MINI3



Jaw for press machine M-BMINI3 - V-profile
Bek voor persmachine M-BMINI3 - V-profiel
Pince pour machine à sertir M-BMINI3 - Profil V
Pressbacke für Presswerkzeuge M-BMINI3 - Profil V

Article number	Box	Type
BE15V-MINI3	1 pc	V-profile 15mm
BE18V-MINI3	1 pc	V-profile 18mm
BE22V-MINI3	1 pc	V-profile 22mm
BE28V-MINI3	1 pc	V-profile 28mm

Our warranty does not apply to other pipe systems with M or V profile. Press tool compatibility: www.henco.be

Type: BE.M-MINI3



Jaw for press machine M-BMINI3 - M-profile
Bek voor persmachine M-BMINI3 - M-profiel
Pince pour machine à sertir M-BMINI3 - Profil M
Pressbacke für Presswerkzeuge M-BMINI3 - Profil M

Article number	Box	Type
BE12M-MINI3	1 pc	M-profile 12mm
BE15M-MINI3	1 pc	M-profile 15mm
BE18M-MINI3	1 pc	M-profile 18mm
BE22M-MINI3	1 pc	M-profile 22mm
BE28M-MINI3	1 pc	M-profile 28mm

Our warranty does not apply to other pipe systems with M or V profile. Press tool compatibility: www.henco.be



Henco Tools

Pressing Tools

Type: M-BATMINI2



Battery 18V / 1,5 Ah Li-ion for M-BMINI2
Accu 18V / 1,5 Ah Li-ion voor M-BMINI2
Batterie 18V / 1,5 Ah Li-ion pour M-BMINI2
Akku 18V / 1,5 Ah Li-ion für M-BMINI2

Article number	Box	Type
M-BATMINI2	1 pc	18V / 1,5 Ah Li-ion

TILL EXHAUSTION OF STOCK

Type: BE..-MINI



Jaw for press machine M-BMINI2(-S) and M-HP32
Bek voor persmachine M-BMINI2(-S) en M-HP32
Pince pour machine à sertir M-BMINI2(-S) et M-HP32
Pressbacke für Presswerkzeuge M-BMINI2(-S) und M-HP32

Article number	Box	Type
BE16MINI	1 pc	BE/TH Ø16
BE20MINI	1 pc	BE/TH Ø20
BE26MINI	1 pc	BE/TH Ø26
BE32MINI	1 pc	BE Ø32

Not applicable to press machine type M-BMINI3

Type: BE..-MMINI



M-profile jaw (copper) for press machine M-BMINI(2)(-S) and M-HP32
M-profiel bek (koper) voor persmachine M-BMINI(2)(-S) en M-HP32
M-profil pines (cuivre) pour machine à sertir M-BMINI(2)(-S) et M-HP32
M-profil Pressbacke (Kupfer) für Presswerkzeuge M-BMINI(2)(-S) und M-HP32

Article number	Bag	Type
BE15MMINI	1 pc	Ø15Cu M-Profile
BE22MMINI	1 pc	Ø22Cu M-Profile

Not applicable to press machine type M-BMINI3

Type: BE-C



V-profile jaw (copper) for press machine M-BMINI2(-S) and M-HP32
V-profiel persbek (koper) voor persmachine M-BMINI2(-S) and M-HP32
V-profil pines (cuivre) pour machine à sertir M-BMINI2(-S) et M-HP32
V-profil Pressbacke (Kupfer) für Presswerkzeuge M-BMINI2(-S) und M-HP32

Article number	Bag	Type
BE15C	1 pc	Ø15Cu V-Profile
BE18C	1 pc	Ø18Cu V-Profile
BE22C	1 pc	Ø22Cu V-Profile
BE28C	1 pc	Ø28Cu V-Profile

Not applicable to press machine type M-BMINI3 Our warranty does not apply to other pipe systems with M or V profile.



Type: BE-MINI



Jaw mounting unit for press machine M-BMINI(2)(-S) / M-HP32 and to be used with BE-H jaws

Bek voor persmachine M-BMINI2(-S) en M-HP-32 en te gebruiken met BE-H persbekken

Pince mère pour machine à sertir M-BMINI(2)(-S) / M-HP32 et à utiliser avec pinces BE-H

Mutterpressbacke für Presswerkzeug M-BMINI(2)(-S) / M-HP32, zu verwenden mit BE-H Backen

Article number	Box	Type
BE-MINI	1 pc	MOTHERJAW

BE-MINI is designed to press Henco press fittings, the interchangeable dies with M- and V-profile make it possible to make the transition from other materials to Henco; other than Henco branded fittings with compact measurements can cause complex manipulation.

Type: BE-MINI-RMS



Jaw mounting unit for mini press machine Rems

Bek voor mini persmachine Rems

Pince mère pour machine à sertir mini Rems

Mutterpressbacke für mini Presswerkzeug Rems

Article number	Box	Type
BE16MINI-RMS	1 pc	BE/TH Ø16
BE20MINI-RMS	1 pc	BE/TH Ø20
BE26MINI-RMS	1 pc	BE/TH Ø26
BE32MINI-RMS	1 pc	BE Ø32



MyHenco

For all specifications of the pressing jaws, you can visit MyHenco.com.

Type: M-BH

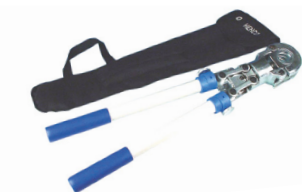

Kit: manual press machine + inserts 16,20,26 + bag

Kit: handpersmachine + bekken 16, 20, 26 + draagtas

Kit: machine à sertir manuelle + pinces 16, 20, 26 + sac

Kit: Handperssmaschine + Pressbacken 16, 20, 26 + Tasche

Article number	Bag	Type
M-BH162026	1 pc	BH 16x2 / 20x2 / 26x3

TILL EXHAUSTION OF STOCK



Henco Tools

Pressing Tools

Type: M-HP



Hydraulic manual press tool + bag
 Hydraulisch handpersmachine + draagtas
 Machine à sertir manuelle hydraulique + sac
 Hydraulisches Handpressmaschine + Tasche

Article number	Bag	Type
M-HP32	1 pc	Ø14-32

Type: M-BM1620



Kit: manual press machine with 16, 20 jaws + bag
 Kit: handpersmachine + wisselbekken 16, 20 + draagtas
 Kit: machine à sertir manuelle + pinces 16, 20 + sac
 Kit: Handpressmaschine + Pressbacken 16, 20 + Tasche

Article number	Bag	Type
M-BM1620	1 pc	BM 16x2 / 20x2

Type: BE-M



Inserts for M-BM1620
 Wisselbekken voor M-BM1620
 Pinces pour M-BM1620
 Pressbacken für M-BM1620

Article number	Bag	Type
BE14M	1 pc	BE 14X2 M
BE16M	1 pc	BE 16X2 M
BE18M	1 pc	BE 18X2 M
BE20M	1 pc	BE 20X2 M

Type: HNTOOLSET



Toolset for the SUPER SIZES range
 Toolset voor het SUPER SIZES gamma
 Set d'outil pour la gamme SUPER SIZES
 Toolset für das SUPER SIZES Angebot

Article number	Box	Type
HNTOOLSET	1 pc	Super Sizes

Type: M-TRANSMINI2



Mains Adapter for M-BMINI2(S)
 Adapter voor netaansluiting M-BMINI2(-S)
 Adapteur raccordement au réseau M-BMINI2(-S)
 Netzadapter für M-BMINI2(-S)

Article number	Box	Type
M-TRANSMINI2	1 pc	Henco mains adapter for M-BMINI2(-s)

TILL EXHAUSTION OF STOCK

Type: M-BOXMINI2



Case for M-BMINI2(-S)
 Koffer voor M-BMINI2(-S)
 Coffret pour M-BMINI2(-S)
 Koffer für M-BMINI2(-S)

Article number	Box	Type
M-BOXMINI2	1 pc	Henco case for M-BMINI2(-s)

TILL EXHAUSTION OF STOCK



Type: SAFECUT



Cutter to open the packing paper
Mes om verpakkingspapier te openen
Couteau pour ouvrir le papier d'emballage
Schneider zum Öffnen der Verpackung

Article number	Box / Big Box	Type
SAFECUT	1 pc / 10 pc	SAFECUT

Type: PRESSCHECK



Tool to control the accuracy of a pressing
Instrument om correctheid v/e persing te controleren
Outil pour contrôler la précision d'un sertissage
Instrument zur Überprüfung ob die Pressung korrekt ausgeführt

Article number	Bag / Box	Type
PRESSCHECK1432	1 pc / 200 pc	Ø14-32

Type: DRILLY



Drilly temporary air vent plug, reusable
Drilly voor afdrukken leidingssysteem, herbruikbaar
Drilly pour tester le système de tubes, réutilisable
Drilly zum abdrucken Rohresysteme, wieder verwendbar

Article number	Box	Type
DRILLY14	1 pc	Ø14
DRILLY16	1 pc	Ø16
DRILLY20	1 pc	Ø20
DRILLY26	1 pc	Ø26
DRILLY32	1 pc	Ø32

Type: PLUG



Plug
Afdrukplug
Bouchon
Stopf

Article number	Box / Big Box	Type
PLUG04-B80	20 pc / 560 pc	1/2" - 80 mm blue
PLUG04-R80	20 pc / 560 pc	1/2" - 80 mm red
PLUG05-B80	20 pc / 560 pc	3/4" - 80 mm blue
PLUG05-R80	20 pc / 560 pc	3/4" - 80 mm red

Type: EK05-TOOL



Assembly key for EK05
Montagesleutel voor EK05
Clé de montage pour EK05
Montageschlüssel für EK05

Article number	Box / Big Box	Type
EK05-TOOL	1 pc	3/4"



Henco Tools

Smart Tools

Type: PS



Pipe straightener
Buizenrechter
Redresseur de tubes
Rohrbegradiger

Article number	Box / Big Box	Type
PS-16	1 pc / 15 pc	Ø16
PS-20	1 pc / 15 pc	Ø20

Characteristics PS

- ✓ Simplifies installation and reduces labour
- ✓ Easy to use
- ✓ Less material usage and waste
- ✓ Accelerated flow for better efficiencies and reduced running costs
- ✓ Professional looking finish



Type: PH



Pipe holder for diameters 16-20-26-32
Griptang voor buis diameter 16-20-26-32
Pince de maintien diamètre 16-20-26-32
Rohrhalter für Diameter 16-20-26-32

Article number	Box / Big Box	Type
PH-1632	1 pc / 70 pc	Ø16 - 20 - 26 - 32

Characteristics PH

- ✓ Always sufficient grip when calibrating short pipe ends
- ✓ Prevents the pipe from turning during calibration
- ✓ Inspired by the classic nutcracker model
- ✓ Henco blue anodised aluminium
- ✓ Lightweight tool
- ✓ Suitable for pipe diameters of 16 - 20 - 26 - 32





Type: PK-TOOL



Wrench for PK/SK fittings with threading
Sleutel voor PK/SK fittings met draad
Clé pour raccords PK/SK filtage
Schlüssel für PK/SK Fittings mit Draht

Article number	Box / Big Box	Type
PK-TOOL04	1 pc / 50 pc	1/2"
PK-TOOL05	1 pc / 50 pc	3/4"
PK-TOOL06	1 pc / 50 pc	1"
PK-TOOL07*	1 pc / 30 pc	5/4"
PK-TOOL08*	1 pc / 30 pc	6/4"
PK-TOOL10*	1 pc / 30 pc	2"

**TILL EXHAUSTION OF STOCK*

Characteristics PK-TOOL

- ✓ Light weight ratchet key
- ✓ Full grip around fitting profile
- ✓ Plastic body stays intact, even when applying extreme torque
- ✓ Key works as well in clock- as counterclockwise direction
- ✓ Maximum torque transition
- ✓ Size indication on handle
- ✓ Chromed handle
- ✓ Key gripping jaws in anodized aluminum
- ✓ Possibility to grip around mounted fittings due to specific closing mechanism

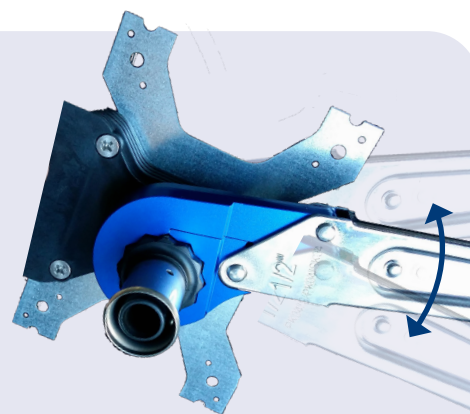

Type: PK-TOOLBOX-040506



Set Wrenches for PK/SK Fittings 1/2" - 1" Threading
Set sleutels voor PK/SK fittings 1/2" tot 1" draad
Set Clés pour raccords PK/SK filtage 1/2" - 1"
Set Schlüssel für PK/SK Fittings 1/2" bis 1" Draht

Article number	Box	Type
PK-TOOLBOX-040506	1 pc	1/2" - 1"

Type: PK-TOOLBOX



Empty plastic case for PK-TOOL04/05/06
Lege kunststof koffer voor PK-TOOL04/05/06
Coffret pour PK-TOOL04/05/06
Koffer für PK-TOOLBOX04/05/06

Article number	Box / Big Box	Type
PK-TOOLBOX	1 pc / 10 pc	CASE



Henco Tools

Underfloor Heating Tools

Type: UFH-VLA



Decoiler, Standard model
Haspel, basismodel
Machine à dérouler, Standard
Abwickelmaschine, Standard

Article number	Box	Type
UFH-VLA	1 pc	25m -600m

Minimum inner diameter coil: 140mm

Type: UFH-VLA-STR

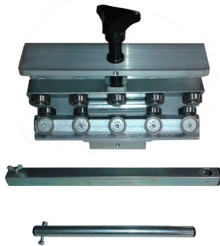

Pipe straightener for decoiler UFH-VLA 14-26mm
Buizenrechter voor haspel UFH-VLA 14-26mm
Machine à produire des barres pour dérouler UFH-VLA 14-26mm
Stangenmaschine für Wickelmaschine UFH-VLA 14-26mm

Article number	Box	Type
UFH-VLA-STR	1 pc	14-26mm

Type: UFH-VLA-STRHO



Holder for pipe straightener ufh-vla-str 14-26mm
Houder voor stangenrechter ufh-vla-str 14-26mm
Soutien pour machine à prod. Des barres ufh-vla-str 14-26mm
Halter für stangenmaschine ufh-vla-str 14-26mm

Article number	Box	Type
UFH-VLA-STRHO	1 pc	Clamp

Type: UFH-TACK



Tacker machine for UFH-TACK-40, UFH-TACK-60
Tackerapparaat voor UFH-TACK-40, UFH-TACK-60
Appareil Tacker pour UFH-TACK-40, UFH-TACK-60
Tackergerät für UFH-TACK-40, UFH-TACK-60

Article number	Box	Type
UFH-TACK	1 pc	

Type: UFH-RAS-VLE



Braid hook
Vlechthaak
Crochet de tressage
Gerät zum Flechten von Stahldraht

Article number	Box	Type
UFH-RAS-VLE	1 pc	

Type: UFH-RAS-CUT



Cutter for steel mesh
Kniptang voor stalen draadmatten
Pince coupante pour treillis
Schere für Trägermatte

Article number	Box	Type
UFH-RAS-CUT	1 pc	



Henco Accessories

	<i>Page</i>
<i>Henco Accessories</i>	<i>178</i>



Henco Accessories

Type: BCLIP



Clip-it clip for Henco pipes, single
 Clip-it beugel voor Henco buizen, enkel
 Clip-it attache de fixation pour tubes henco, simple
 Clip-it Bügel für Henco Rohre, einfach

Article number	Box	Type
BCLIP-16	100 pc	Ø16
BCLIP-1820	100 pc	Ø18 - 20
BCLIP-26	100 pc	Ø26
BCLIP-32	100 pc	Ø32
BCLIP-40*	100 pc	Ø40
BCLIP-50*	50 pc	Ø50

**TILL EXHAUSTION OF STOCK*

Type: JCLIP DOUBLE



J-clip pipe clips, double
 J-clip beugels, dubbel
 Attaches de fixation J-clip, double
 J-clip Haken, doppelt

Article number	Box	Type
JCLIP-1632D	200 pc	Ø16-32, 70 mm

TILL EXHAUSTION OF STOCK

Type: PIPEPLUG



Protection cap for pipe
 Beschermstopje voor buis
 Capuchon de protection pour tube
 Schutzkappe für Rohr

Article number	Bag / Box	Type
PIPEPLUG16	25 pc / 500 pc	Ø 16
PIPEPLUG20	25 pc / 500 pc	Ø 20
PIPEPLUG26	25 pc / 300 pc	Ø 26



Type: PLP-P-PK



Galvanised bracket for backplate elbow
Gebogen tappuntbeugel gegalvaniseerd
Support galvanisé pour culasse sanitaire
Halteplatte galvanisiert

Article number	Bag / Box	Type
PLP-P-PK	1 pc / 20 pc	<i>Interaxis 153mm</i>

Type: PLF-P-PK



Galvanised bracket flat for backplate elbow
Vlakke tappuntbeugel gegalvaniseerd
Support galvanisé pour culasse sanitaire
Halteplatte flach galvanisiert

Article number	Bag / Box	Type
PLF-P-PK	1 pc / 40 pc	<i>Interaxis 120mm and 153mm</i>

Type: PLF-3P-VK-U



Wall plate bracket for 3P-VK-U
Muurplaatbeugel voor 3P-VK-U
Support de plaque murale pour 3P-VK-U
Wandplattenhalter für 3P-VK-U

Article number	Bag / Box	Type
PLF-3P-VK-U	1 pc / 40 pc	<i>Interaxis 120mm and 153mm</i>

Type: TESTPLUG



Testcap for Henco pipe
Kunststof afpersplug voor Henco buis
Capuchon de teste pour tube
Testkappe für Rohr

Article number	Bag / Box	Type
TESTPLUG16	20 pc / 4000 pc	Ø16
TESTPLUG20	20 pc / 2000 pc	Ø20
TESTPLUG26	20 pc / 1000 pc	Ø26

Type: TESTPLUG-RO



Testcap red for Henco pipe
Kunststof afpersplug rood voor Henco buis
Capuchon de teste rouge pour tube
Testkappe roth für Rohr

Article number	Bag / Box	Type
TESTPLUG16-RO	20 pc / 4000 pc	Ø16
TESTPLUG20-RO	20 pc / 2000 pc	Ø20
TESTPLUG26-RO	20 pc / 1000 pc	Ø26



Henco Accessories

Type: AK-EK



Adapter from 3/4" EK to flat sealing
 Adapter kunststof - EK 3/4" naar vlakdichtend
 Adapteur EK 3/4" vers joint plat
 Adapter von EK 3/4" nach AG Flachdichtend

Article number	Bag / Big Box	Type
AK-EK05VD	50 pc / 1000 pc	

Type: BD



Mounting/repair tape
 Montage-/hersteltape
 Bande de montage/réparation
 Montage/Reparaturband

Article number	Box	Type
BDR33M	36 pc	33m x 50mm
BDB33M	36 pc	33m x 50mm

Type: HFMAN



EPDM sleeve for hencoflex
 EPDM manchette hencoflex
 Manchon EPDM pour hencoflex
 EPDM Hülse für Hencoflex

Article number	Bag / Box	Type
HFMAN125	1 pc / 30 pc	

Type: SS2PK



Isolation for wall plate elbow 2PK04
 Isolatie muurplaat type 2PK04
 Isolation pour plaque murale type 2PK04
 Schallschutz für Wandscheibe 2PK04

Article number	Bag	Type
SS2PK04	1 pc	

Type: SS3P



Isolation for wall plate elbow 3P04
 Isolatie muurplaat type 3P04
 Isolation pour plaque murale type 3P04
 Schallschutz für Wandscheibe 3P04

Article number	Bag	Type
SS3P04	1 pc	



Henco Sprinkler

	<i>Page</i>
<i>Henco Press Sprinkler</i>	<i>182</i>
<i>Henco PRO-Sprinkler</i>	<i>189</i>



Henco Sprinkler

Henco Press Sprinkler



Sprinkler: only allowed in countries where a Henco Sprinkler certificate is available!
(see www.henco.be)

Sprinkler: seulement permis dans des pays où le Henco Sprinkler certificat est disponible!
(Consultez www.henco.be)

Sprinkler: enkel toegelaten in landen waar er een Henco Sprinkler certificaat voorhanden is!
(zie www.henco.be)

Sprinkler: nur zugelassen in Länder wo Henco Sprinkler Zertifikat vorhanden ist!
(Siehe www.henco.be)

Type: 1PKS



Elbow 90°
Knie 90°
Coude 90°
Winkel 90°

Article number	Bag / Box	Type
1PKS-3232	5 pc / 30 pc	32x32
1PKS-4040	5 pc / 20 pc	40x40
1PKS-5050	1 pc / 8 pc	50x50
1PKS-6363	1 pc / 6 pc	63x63

Type: 5PKS (CW617N)



Elbow 90° male adapter
Knie 90° buitendraad
Coude 90° mâle
Winkel 90° AG

Article number	Bag / Box	Type
5PKS-3206	5 pc / 20 pc	32x1"
5PKS-4007	3 pc / 15 pc	40x5/4"
5PKS-5007	1 pc / 10 pc	50x 5/4"
5PKS-5008	1 pc / 8 pc	50x 6/4"
5PKS-6310	1 pc / 4 pc	63x2"

TILL EXHAUSTION OF STOCK

Type: 5PKS-N (CW602N)



Elbow 90° male adapter
Knie 90° buitendraad
Coude 90° mâle
Winkel 90° AG

Article number	Bag / Box	Type
5PKS-3206-N*	5 pc / 20 pc	32x1"
5PKS-4007-N*	3 pc / 15 pc	40x 5/4"
5PKS-5007-N	1 pc / 10 pc	50x 5/4"
5PKS-5008-N	1 pc / 8 pc	50x6/4"
5PKS-6310-N	1 pc / 4 pc	63x2"

*TILL EXHAUSTION OF STOCK



Type: 6PKS (CW617N) 



Elbow 90° female adapter
Knie 90° binnendraad
Coude 90° femelle
Winkel 90° IG

Article number	Bag / Box	Type
6PKS-3204	5 pc / 20 pc	32x1/2"
6PKS-3206	5 pc / 20 pc	32x1"
6PKS-4004*	5 pc / 15 pc	40x1/2"
6PKS-4007	5 pc / 15 pc	40x5/4"
6PKS-5004*	1 pc / 8 pc	50x1/2"
6PKS-5007*	1 pc / 8 pc	50x5/4"
6PKS-5008*	1 pc / 8 pc	50x6/4"
6PKS-6304*	1 pc / 4 pc	63x1/2"
6PKS-6310	1 pc / 4 pc	63x2"

**TILL EXHAUSTION OF STOCK*

Type: 6PKS-N (CW602N) 



Elbow 90° female adapter
Knie 90° binnendraad
Coude 90° femelle
Winkel 90° IG

Article number	Bag / Box	Type
6PKS-3204-N*	5 pc / 20 pc	32x1/2"
6PKS-3206-N*	5 pc / 20 pc	32x1"
6PKS-4004-N*	5 pc / 15 pc	40x1/2"
6PKS-4007-N	5 pc / 15 pc	40x5/4"
6PKS-5004-N	1 pc / 8 pc	50x1/2"
6PKS-5007-N	1 pc / 8 pc	50x5/4"
6PKS-5008-N	1 pc / 8 pc	50x 6/4"
6PKS-6304-N	1 pc / 4 pc	63x1/2"
6PKS-6310-N	1 pc / 4 pc	63x2"

**TILL EXHAUSTION OF STOCK*

Type: 9PKS



T-piece
T-stuk
Pièce en T
T-Stück

Article number	Bag / Box	Type
9PKS-323232	5 pc / 15 pc	32x32x32
9PKS-404040	5 pc / 10 pc	40x40x40
9PKS-505050	1 pc / 6 pc	50x50x50
9PKS-636363	1 pc / 3 pc	63x63x63



Henco Sprinkler

Henco Press Sprinkler

Type: 10PKS



T-reduced centre
T-verlopend
Pièce en T réduit
T-reduziert

Article number	Bag / Box	Type
10PKS-403240	5 pc / 10 pc	40x32x40
10PKS-503250	1 pc / 8 pc	50x32x50
10PKS-504050	1 pc / 6 pc	50x40x50
10PKS-633263	1 pc / 3 pc	63x32x63
10PKS-634063	1 pc / 3 pc	63x40x63
10PKS-635063*	1 pc / 3 pc	63x50x63

**TILL EXHAUSTION OF STOCK*

Type: 11PKS



T-branch and line reduced
T-2x verlopend
Pièce en T 2x réduit
T-2x reduziert

Article number	Bag / Box	Type
11PKS-404032	5 pc / 10 pc	40x40x32
11PKS-503240*	1 pc / 10 pc	50x32x40

**TILL EXHAUSTION OF STOCK*

Type: 12PKS



T-enlarged branch
T-vergroot
Pièce en T agrandi
T-erweitert

Article number	Bag / Box	Type
12PKS-324032	5 pc / 15 pc	32x40x32
12PKS-405040	1 pc / 8 pc	40x50x40

TILL EXHAUSTION OF STOCK



Type: 13PKS (CW617N) 



T-female centre
T-binnendraad
Pièce en T femelle
T-IG

Article number	Bag / Box	Type
13PKS-320432*	5 pc / 15 pc	32x1/2"x32
13PKS-320532	5 pc / 15 pc	32x3/4"x32
13PKS-320632*	5 pc / 10 pc	32x1"x32
13PKS-320732*	5 pc / 10 pc	32x5/4"x32
13PKS-400440*	5 pc / 10 pc	40x1/2"x40
13PKS-400640*	5 pc / 10 pc	40x1"x40
13PKS-400740*	5 pc / 10 pc	40x5/4"x40
13PKS-500450*	1 pc / 4 pc	50x1/2"x50
13PKS-500550*	1 pc / 4 pc	50x3/4"x50
13PKS-500850*	1 pc / 4 pc	50x6/4"x50
13PKS-631063	1 pc / 2 pc	63x2"x63
13PKS-630463*	1 pc / 2 pc	63x1/2"x63

**TILL EXHAUSTION OF STOCK*

Type: 13PKS-N (CW602N)



T-female centre
T-binnendraad
Pièce en T femelle
T-IG

Article number	Bag / Box	Type
13PKS-320532-N	5 pc / 15 pc	32x3/4"x32
13PKS-320632-N	5 pc / 10 pc	32x1"x32
13PKS-320732-N*	5 pc / 10 pc	32x5/4"x32
13PKS-400440-N*	5 pc / 10 pc	40x1/2"x40
13PKS-400640-N*	5 pc / 10 pc	40x1"x40
13PKS-400740-N	5 pc / 10 pc	40x5/4"x40
13PKS-500450-N	1 pc / 4 pc	50x1/2"x50
13PKS-500550-N	1 pc / 4 pc	50x3/4"x50
13PKS-500850-N	1 pc / 4 pc	50x6/4"x50
13PKS-630463-N	1 pc / 2 pc	63x1/2"x63
13PKS-631063-N	1 pc / 2 pc	63x2"x63

**TILL EXHAUSTION OF STOCK*

Type: 14PKS (CW617N) 



T-male centre
T-buitendraad
Pièce en T mâle
T-AG

Article number	Bag / Box	Type
14PKS-320532	5 pc / 15 pc	32x3/4"x32
14PKS-400640	5 pc / 10 pc	40x1"x40
14PKS-400740	5 pc / 10 pc	40x5/4"x40
14PKS-500850	1 pc / 5 pc	50x6/4"x50
14PKS-631063	1 pc / 2 pc	63x2"x63

TILL EXHAUSTION OF STOCK



Henco Sprinkler

Henco Press Sprinkler

Type: 14PKS-N (CW602N)



T-male centre CW602
T-buitendraad CW602
Pièce en T mâle CW602
T-AG CW602

Article number	Bag / Box	Type
14PKS-320532-N	5 pc / 15 pc	32x3/4"x32
14PKS-400640-N	5 pc / 10 pc	40x1"x40
14PKS-400740-N	5 pc / 10 pc	40x5/4"x40
14PKS-500850-N	1 pc / 5 pc	50x6/4"x50
14PKS-631063-N	1 pc / 2 pc	63x2"x63

Type: 15PKS



Straight coupling
Perssok
Manchon
Kupplung

Article number	Bag / Box	Type
15PKS-3232	5 pc / 30 pc	32x32
15PKS-4040	5 pc / 25 pc	40x40
15PKS-5050	1 pc / 12 pc	50x50
15PKS-6363	1 pc / 9 pc	63x63

Type: 16PKS



Reducing coupling
Verloopstuk
Réduction
Kupplung-reduziert

Article number	Bag / Box	Type
16PKS-4032	5 pc / 25 pc	40x32
16PKS-5032	1 pc / 15 pc	50x32
16PKS-5040*	1 pc / 15 pc	50x40
16PKS-6340	1 pc / 8 pc	63x40
16PKS-6350*	1 pc / 8 pc	63x50

**TILL EXHAUSTION OF STOCK*

Type: 17PKS (CW617N)



Straight male adapter
Puntstuk
Raccord droit mâle
Übergangsfitting AG

Article number	Bag / Box	Type
17PKS-3206	10 pc / 40 pc	32x1"
17PKS-3207	5 pc / 25 pc	32x5/4"
17PKS-4006	5 pc / 25 pc	40x1"
17PKS-4007	5 pc / 25 pc	40x5/4"
17PKS-5008	1 pc / 10 pc	50x6/4"
17PKS-6310	1 pc / 6 pc	63x2"

TILL EXHAUSTION OF STOCK



Type: 17PKS-N (CW602N) 



Straight male adapter CW602
Puntstuk CW602
Raccord droit mâle CW602
Übergangsfitting AG CW602

Article number	Bag / Box	Type
17PKS-3206-N	10 pc / 40 pc	32x1"
17PKS-3207-N*	5 pc / 25 pc	32x5/4"
17PKS-4006-N	5 pc / 25 pc	40x1"
17PKS-4007-N	5 pc / 25 pc	40x5/4"
17PKS-5008-N	1 pc / 10 pc	50x6/4"
17PKS-6310-N	1 pc / 6 pc	63x2"

**TILL EXHAUSTION OF STOCK*

Type: 18PKS (CW617N) 



Straight female adapter
Recht aansluitstuk binnendraad
Raccord droit femelle
Übergangsfitting IG

Article number	Bag / Box	Type
18PKS-3204*	10 pc / 40 pc	32x1/2"
18PKS-3206	10 pc / 40 pc	32x1"
18PKS-3207*	5 pc / 25 pc	32x5/4"
18PKS-4006*	5 pc / 25 pc	40x1"
18PKS-4007*	5 pc / 25 pc	40x5/4"
18PKS-5008*	1 pc / 10 pc	50x6/4"
18PKS-6310	1 pc / 6 pc	63x2"

**TILL EXHAUSTION OF STOCK*

Type: 18PKS-N (CW602N) 



Straight female adapter
Recht aansluitstuk binnendraad
Raccord droit femelle
Übergangsfitting IG

Article number	Bag / Box	Type
18PKS-3204-N	10 pc / 40 pc	32x1/2"
18PKS-3206-N	10 pc / 40 pc	32x1"
18PKS-3207-N*	5 pc / 25 pc	32x5/4"
18PKS-4006-N	5 pc / 25 pc	40x1"
18PKS-4007-N	5 pc / 25 pc	40x5/4"
18PKS-5008-N	1 pc / 10 pc	50x6/4"
18PKS-6310-N	1 pc / 6 pc	63x2"

**TILL EXHAUSTION OF STOCK*



Henco Sprinkler

Henco Press Sprinkler

Type: 27PKS



Elbow 45°
Knie 45°
Coude 45°
Winkel 45°

Article number	Bag / Box	Type
27PKS-3232	5 pc / 30 pc	32x32
27PKS-4040	5 pc / 25 pc	40x40
27PKS-5050	1 pc / 10 pc	50x50
27PKS-6363*	1 pc / 5 pc	63x63

**TILL EXHAUSTION OF STOCK*

Type: 52PS



Mounting/repair fitting
Montage/reparatie fitting Sprinkler
Raccord montage/reparation
Montage/reparatur fitting

Article number	Bag / Box	Type
52PS32	1 pc / 20 pc	32x32

Type: 53PKS



Easymounting/repair fitting
Montage/reparatie fitting Sprinkler
Raccor montage/reparation
Montage/reparatur fitting

Article number	Bag / Box	Type
53PKS40	1 pc / 20 pc	40x40
53PKS50	1 pc / 9 pc	50x50
53PKS63	1 pc / 6 pc	63x63

Type: 50P



Stainless steel sprinkler connection with stainless steel cup
RVS instort sprinkler-aansluiting met RVS cup
Raccord sprinkler en acier inoxydable avec coupelle en acier inoxydable
Sprinkler-Anschluss aus Edelstahl mit Edelstahltasse

Article number	Bag / Box	Type
50P-3206*	1 pc / 15 pc	32x1"
50P-320604*	1 pc / 15 pc	32x1/2"
50P-320605*	1 pc / 15 pc	32x3/4"
50P43-320604*	1 pc / 15 pc	32x1"x1/2"

**TILL EXHAUSTION OF STOCK*



Type: 6PKS-OP (CW617N) 



Elbow 90° female adapter with pressure test plug
Bocht 90° binnendraad met afpersplug
Coude 90° femelle avec bouchon pour essai de pression
Winkel 90° IG mit Stopfen für für Prüfdruck

Article number	Bag	Type
6PKS-3206OP	5 pc	32x1"x32 + plug

Type: 13PKS-OP (CW617N) 



T-female branch with pressure test plug
T-binnendraad met afpersplug
Pièce en T femelle avec bouchon pour essai de pression
T-IG mit Stopfen für für Prüfdruck

Article number	Bag / Box	Type
13PKS-320632OP	5 pc / 10 pc	32x1" + plug

Type: 18PKS-OP (CW617N) 



Straight female adapter with pressure test plug
Recht aansluitstuk binnendraad met afpersplug
Raccord droit femelle avec bouchon pour essai de pression
Übergangsfitting IG mit Stopfen für für Prüfdruck

Article number	Bag / Box	Type
18PKS-3206OP	10 pc / 40 pc	32x1" + plug

Type: SPR-OP



Pressure test plug with O-ring
Afpersplug met O-ring
Bouchon avec joint torique pour essai de pression
Stopfen mit O-Ring für Prüfdruck

Article number	Bag / Box	Type
SPR-OP06	100 pc / 1000 pc	1"

Type: SPR-CBLOCK



Concrete sprinkler cup to embed
Instort sprinklercup in beton
Connexion sprinkler à encastrer en béton
Sprinkler-Anschluss im Beton zum Eingiessen

Article number	Box	Type
SPR-CBLOCK	18 pc	Height = 65 mm
SPR-CBLOCK80	16 pc	Height = 80 mm

Type: SPR-PLUGTOOL



Tool to remove pressure test plug and mount reducer
Tool voor verwijderen afpersplug en monteren verloopnippel
Outil pour retirer bouchon et monter réduction
Werkzeug pour entfernen Pessettestopfen und montieren Reduktion

Article number	Bag	Type
SPR-PLUGTOOL	5 pc	Plugtool

- 1
- 2
- 3
- 4
- 5
- 6
- 7
- 8
- 9
- 10
- 11
- 12
- 13
- 14



Henco Sprinkler

Henco PRO-Sprinkler

Type: SPR-MAGNET



Magnet fixation
Fixation magnétique
Magneetfixatie
Magnet Fixierung

Article number	Box	Type
SPR-MAGNET31	20 pc	Height = 31 mm

Type: SPR-FIX



Fixation for concrete sprinkler cup to embed
Fixatie voor instort sprinklercup in beton
Fixation pour connexion sprinkler à encastrer en béton
Fixierung für Sprinkler-Anschluss im Beton zum Eingiessen

Article number	Bag / Box	Type
SPR-FIXSCREW	60 pc / 360 pc	SCREW FIXATION

Type: SPR-ISO



Insulation for glue and screw fixation
Isolatie voor lijm- en schroeffixatie
Isolation pour fixation à coller et à visser.
Isolierung für Fixierung zum Schrauben und Kleben

Article number	Box	Type
SPR-ISO	500 pc	PE

Type: SPR-N0604

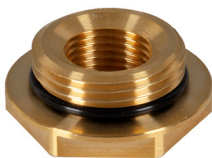

Reduction 1" M - 1/2" F; different built-in depths for SPR-CBLOCK (L) and SPR-CBLOCK-WS (H)
Reductie 1" BuDr-1/2" BiDr; verschillende inbouwdieptes SPR-CBLOCK (L) en SPR-CBLOCK-WS (H)
Réduction 1" F-1/2" M; différentes profondeurs d'installation SPR-CBLOCK (L) et SPR-CBLOCK-WS (H)
Reduktion 1" IG-1/2" AG; unterschiedliche Einbautiefen SPR-CBLOCK (L) und SPR-CBLOCK-WS (H)

Article number	Box / Box	Type
SPR-N0604IDLXXH00	56 pc	L: --mm - H: 00mm
SPR-N0604IDLXXH05	60 pc	L: --mm - H: 5mm
SPR-N0604IDLXXH10	63 pc	L: --mm - H: 10mm
SPR-N0604IDL00H15	6 pc / 72 pc	L: 00mm - H: 15mm
SPR-N0604IDL05H20	6 pc / 72 pc	L: 05mm - H: 20mm
SPR-N0604IDL10H25	6 pc / 84 pc	L: 10mm - H: 25mm
SPR-N0604IDL15H30	6 pc / 108 pc	L: 15mm - H: 30mm
SPR-N0604IDL20H35	6 pc / 108 pc	L: 20mm - H: 35mm
SPR-N0604IDL25H40	6 pc / 120 pc	L: 25mm - H: 40mm
SPR-N0604IDL30H45	6 pc / 120 pc	L: 30mm - H: 45mm

L: built-in depth for SPR-CBLOCK H: built-in depth for SPR-CBLOCK-80-WS

Certificates - Certificaten - Approbations - Zertifikate



GERMANY



AUSTRIA



FRANCE



THE NETHERLANDS



POLAND



DENMARK



BELGIUM



ITALY



RUSSIA



SLOVAKIA



ATG SYSTEM CERTIFICATE BELGIUM



NORWAY



FINLAND



HUNGARY



ENGLAND



SWEDEN



USA



NATIONAL BOARD FOR HEALTH PROTECTION

ESTONIA



SPAIN



CZECH REPUBLIC



SOUTH AFRICA



The MyHenco platform is the perfect fit.

MyHenco, a digital assistant that is always within reach & available 24/7.

More than just an online catalogue.
Designed with a dynamic and user-friendly platform.

MyHenco allows a personalised dashboard, features support articles and video's and helps to answer any queries merchants and tradesmen may have.

Sign up to MyHenco at MyHenco.com



Article	p.	Article	p.	Article	p.	Article	p.
1-1403C-S	101	1PKW-2020	38	2PKG-2005	47	3P-200420VK	79
1-1404-S	101	1PKW-2626	38	2PKG-2605	47	3P-200420VK-U	79
1-1604-S	101	1PKW-3232	38	2PKW-1604	38	3P-260426VK	79
1-1605-S	101	1SK-1616	68	2PKW-1604K	39	3PK-160416BP	27
1-1804-S	101	1SK-2020	68	2PKW-1604K-N	39	3PK-160416-X	27
1-1805	101	1SK-2626	68	2PKW-1604K-X	39	3PK-200420BP	27
1-2004-S	101	2-1616-S	101	2PKW-1604-N	38	3PK-200420-X	27
1-2005-S	101	2-2020-S	101	2PKW-1604-X	39	3PKW-160416	40
1-2605-S	101	2-2626-S	101	2PKW-2004	38	3PKW-160416-N	40
1-2606-S	101	2C-0404	107	2PKW-2004-N	38	3PKW-160416-X	40
1-3206-S	101	2P-1404K	78	2PKW-2004-X	39	3PKW-200420	40
1HNA	56	2P-1604	78	2PKW-2005	38	3PKW-200420-N	40
1HNB	56	2P-1604K	78	2PKW-2005-N	38	3PKW-200420-X	40
1P-1616	78	2P-1804	78	2PKW-2005-X	39	03-R160212	14
1P-2020	78	2P-2004	78	2PKW-2605	38	03-R200216	14
1P-2626	78	2P-2005	78	2PKW-2605-N	38	03-R260320	14
1P-3232	78	2P-2605	78	2PKW-2605-X	39	3SK-160416BP	68
1PG-1616	95	2PG-1604	95	2S-1604K	69	3SK-200420BP	68
1PG-2020	95	2PG-1604K	95	2SK-1604BP	69	4-1616-S	102
1PG-2626	95	2PG-2004	95	2SK-2004BP	69	4-2020-S	102
1PK-20JG10	26	2PG-2005	95	2SK-2005	69	4-2626-S	102
1PK-1414	26	2PG-2605	95	2SK-2605	69	4-3232-S	102
1PK-1616	26	2PK-1404BP	26	3-1604-S	101	04-160212	8
1PK-1818	26	2PK-1404-X	27	3-1804-S	101	04-200216	8
1PK-2020	26	2PK-1603	26	3-2004-S	101	04-260320	8
1PK-2626	26	2PK-1604BP	26	3-2005-S	101	04-320326	8
1PK-3232	26	2PK-1604KBP	26	3-2605-S	101	04-403533	8
1PK-4040	26	2PK-1604K-X	27	3-2606-S	101	04-504042	8
1PK-5050	26	2PK-1604-X	27	3-3206A	101	04-634554	8
1PK-6363	26	2PK-1804BP	26	03-160212	8	4P-1604	79
1PK-7575	60	2PK-1804-X	27	03-180214	8	4P-2004	79
1PK-9090	60	2PK-2004BP	26	03-200216	8	04-R160212	14
1PKG-1616	47	2PK-2004-X	27	03-260320	8	04-R200216	14
1PKG-2020	47	2PK-2005	26	03-320326	8	04-R260320	14
1PKG-2626	47	2PK-2005-X	27	03-403533	8	5-1604-S	102
1PKG-3232	47	2PK-2605	26	03-504042	8	5-1804	102
1PKS-3232	182	2PK-2605-X	27	03-634554	8	5-2005-S	102
1PKS-4040	182	2PKG-1603	47	3EK-050405	106	5-2606-S	102
1PKS-5050	182	2PKG-1604BP	47	3P-160416	78	05-160212	8
1PKS-6363	182	2PKG-1604KBP	47	3P-160416VK-U	79	05-160212-GAS	23
1PKW-1616	38	2PKG-2004BP	47	3P-200420	78	05-180214	8

Index

Article	p.	Article	p.	Article	p.	Article	p.
05-200216	8	5PK-7510	61	6P-1604	80	6PK-7512-N	61
05-200216-GAS	23	5PK-7510-N	61	6P-1804	80	6PK-9014	61
05-260320	8	5PK-7512	61	6P-2004	80	6PK-9014-N	61
05-260320-GAS	23	5PK-7512-N	61	6P-2005	80	6PKG-1604BP	48
05-320326	8	5PKG-1604	48	6P-2605	80	6PKG-2004BP	48
05-320326-GAS	23	5PKG-2004	48	6PG-1604	96	6PKG-2005	48
05-320326-SPR	24	5PKG-2005	48	6PG-2004	96	6PKG-2605	48
05-403533	8	5PKG-2605	48	6PG-2005	96	6PKG-3206	48
05-403533-SPR	24	5PKG-3206	48	6PG-2605	96	6PKS-3204	183
05-504042	8	5PKG-4007	48	6PK-1404BP	28	6PKS-3204-N	183
05-504042-SPR	24	5PKS-3206	182	6PK-1404-X	29	6PKS-3206	183
05-634554	8	5PKS-3206-N	182	6PK-1603	28	6PKS-3206-N	183
05-634554-SPR	24	5PKS-4007	182	6PK-1604BP	28	6PKS-3206OP	189
05-756063	8	5PKS-4007-N	182	6PK-1604-X	29	6PKS-4004	199
05-907076	8	5PKS-5007	182	6PK-1804BP	28	6PKS-4004-N	183
5P-1603	79	5PKS-5007-N	182	6PK-1804-X	29	6PKS-4007	183
5P-1603DZR	80	5PKS-5008	182	6PK-2004BP	28	6PKS-4007-N	183
5P-1604	79	5PKS-5008-N	182	6PK-2004-X	29	6PKS-5004	183
5P-1604DZR	80	5PKS-6310	182	6PK-2005	28	6PKS-5004-N	183
5P-2004	79	5PKS-6310-N	182	6PK-2005-X	29	6PKS-5007	183
5P-2005	79	5PKW-1604	40	6PK-2605	28	6PKS-5007-N	183
5P-2605	79	5PKW-1604-N	40	6PK-2605-X	29	6PKS-5008	183
5P-2606	79	5PKW-2004	40	6PK-3206	28	6PKS-5008-N	183
5P-3206	79	5PKW-2004-N	40	6PK-3206-X	29	6PKS-6304	183
5PG-1604	96	5PKW-2005	40	6PK-4007	28	6PKS-6304-N	183
5PG-2005	96	5PKW-2005-N	40	6PK-4007-N	29	6PKS-6310	183
5PK-1404	28	5PKW-2605	40	6PK-4007-X	29	6PKS-6310-N	183
5PK-1604	28	5PKW-2605-N	40	6PK-5007	28	6PKW-1603	41
5PK-1804	28	5PKW-3206	40	6PK-5007-N	29	6PKW-1603-N	41
5PK-2004	28	5PKW-3206-N	40	6PK-5007-X	29	6PKW-1604	41
5PK-2005	28	05-R160212	14	6PK-5008	28	6PKW-1604-N	41
5PK-2605	28	05-R200216	14	6PK-5008-N	29	6PKW-1604-X	41
5PK-3206	28	05-R260320	14	6PK-5008-X	29	6PKW-2004	41
5PK-4007	28	5SK-1604	69	6PK-6310	28	6PKW-2004-N	41
5PK-4007-N	28	5SK-2004	69	6PK-6310-N	29	6PKW-2004-X	41
5PK-5007	28	5SK-2005	69	6PK-6310-X	29	6PKW-2005	41
5PK-5007-N	28	5SK-2605	69	6PK-7506	61	6PKW-2005-N	41
5PK-5008	28	6-1604-S	102	6PK-7506-N	61	6PKW-2005-X	41
5PK-5008-N	28	6-1804	102	6PK-7510	61	6PKW-2605	41
5PK-6310	28	6-2004-S	102	6PK-7510-N	61	6PKW-2605-N	41
5PK-6310-N	28	6-2005-S	102	6PK-7512	61	6PKW-2605-X	41

Article	p.	Article	p.	Article	p.	Article	p.
6PKW-3206	41	9PKG-161616	48	10PK-503250	31	11P-262020	81
6PKW-3206-N	41	9PKG-202020	48	10PK-504050	31	11P-262616	81
6PKW-3206-X	41	9PKG-262626	48	10PK-632663	31	11P-262620	81
6SK-1604BP	69	9PKG-323232	48	10PK-633263	31	11P-322626	81
6SK-2004BP	69	9PKS-323232	183	10PK-634063	31	11PG-201616	97
6SK-2005	69	9PKS-404040	183	10PK-635063	31	11PG-262020	97
6SK-2605	69	9PKS-505050	183	10PK-753275	62	11PK-161414	31
6VBS-2005	119	9PKS-636363	183	10PK-754075	62	11PK-181616	31
6VBS-2605	119	9PKW-161616	42	10PK-755075	62	11PK-201616	31
7-1604-S	103	9PKW-202020	42	10PK-756375	62	11PK-201818	31
7P-1605	84	9PKW-262626	42	10PK-903290	62	11PK-202016	31
7P-1605K	84	9PKW-323232	42	10PK-904090	62	11PK-261616	31
7P-1605L	84	9SK-161616	69	10PK-905090	62	11PK-261620	31
8-161616-S	107	9SK-202020	69	10PK-906390	62	11PK-262016	31
8-262626A	107	9SK-262626	69	10PK-907590	62	11PK-262020	31
8HNA-PK32	56	10-1604SN	103	10PKG-201620	49	11PK-262616	31
8HNA-PK40	56	10-160212-KB	7	10PKG-261626	49	11PK-262620	31
8HNA-PK50	56	10P-201620	81	10PKG-262026	49	11PK-322026	31
8HNA-PK63	56	10P-261626	81	10PKG-321632	49	11PK-322626	31
8HNA-PK75	56	10P-262026	81	10PKG-322032	49	11PK-402032	31
8HNB-PK90	56	10PG-262026	97	10PKG-322632	49	11PK-402632	31
8P-1604	84	10PK-20JG1020	31	10PKG-401640	49	11PK-403232	31
9HNA	56	10PK-161416	31	10PKS-403240	184	11PK-404026	31
9HNB	56	10PK-181418	31	10PKS-503250	184	11PK-404032	31
9P-161616	81	10PK-181618	31	10PKS-504050	184	11PK-502040	31
9P-181818	81	10PK-201420	31	10PKS-633263	184	11PK-502640	31
9P-202020	81	10PK-201620	31	10PKS-634063	184	11PK-503240	31
9P-262626	81	10PK-201820	31	10PKS-635063	184	11PK-504040	31
9PG-202020	96	10PK-261626	31	10PKW-201620	42	11PK-753232	62
9PG-262626	96	10PK-261826	31	10PKW-261626	42	11PK-753240	62
9PK-141414	30	10PK-262026	31	10PKW-262026	42	11PK-753250	62
9PK-161616	30	10PK-321632	31	10PKW-321632	42	11PK-753263	62
9PK-181818	30	10PK-321832	31	10PKW-322032	42	11PK-754040	62
9PK-202020	30	10PK-322032	31	10PKW-322632	42	11PK-754050	62
9PK-262626	30	10PK-322632	31	10-R160212-KB	14	11PK-754063	62
9PK-323232	30	10PK-401640	31	10SK-201620	69	11PK-755050	62
9PK-404040	30	10PK-402040	31	10SK-261626	69	11PK-755063	62
9PK-505050	30	10PK-402640	31	10SK-262026	69	11PK-756363	62
9PK-636363	30	10PK-403240	31	11P-201616	81	11PK-903232	62
9PK-757575	62	10PK-502050	31	11P-202016	81	11PK-903240	62
9PK-909090	62	10PK-502650	31	11P-261620	81	11PK-903250	62

Index

Article	p.	Article	p.	Article	p.	Article	p.
11PK-903263	62	11SK-262616	70	13PG-200420	97	13PK-750675-N	63
11PK-903275	62	11SK-262620	70	13PG-260426	97	13PK-751075	63
11PK-904040	62	12P-162016	81	13PK-160416BP	32	13PK-751075-N	63
11PK-904050	62	12P-202620	81	13PK-160416-X	32	13PK-751275	63
11PK-904063	62	12PK-161816	31	13PK-180418BP	32	13PK-751275-N	63
11PK-904075	62	12PK-162016	31	13PK-180418-X	32	13PK-901490	63
11PK-905050	62	12PK-202620	31	13PK-200420BP	32	13PK-901490-N	63
11PK-905063	62	12PK-263226	31	13PK-200420-X	32	13PKG-160416BP	50
11PK-905075	62	12PK-324032	31	13PK-200520	32	13PKG-200420BP	50
11PK-906363	62	12PK-327532	63	13PK-200520-X	32	13PKG-200520	50
11PK-906375	62	12PK-329032	63	13PK-260420BP	32	13PKG-260420BP	50
11PK-907575	62	12PK-405040	31	13PK-260420-X	32	13PKG-260426BP	50
11PKG-201616	49	12PK-407540	63	13PK-260426BP	32	13PKG-260526	50
11PKG-202016	49	12PK-409040	63	13PK-260426-X	32	13PKG-320532	50
11PKG-261620	49	12PK-507550	63	13PK-260526	32	13PKG-320632	50
11PKG-262016	49	12PK-509050	63	13PK-260526-X	32	13PKG-320732	50
11PKG-262020	49	12PK-637563	63	13PK-320532	32	13PKS-320432	185
11PKG-262616	49	12PK-639063	63	13PK-320532-X	32	13PKS-320532	185
11PKG-262620	49	12PK-759075	63	13PK-320632	32	13PKS-320532-N	185
11PKG-322026	49	12PKG-162016	49	13PK-320632-X	32	13PKS-320632	185
11PKG-322626	49	12PKG-202620	49	13PK-320732	32	13PKS-320632-N	185
11PKG-402632	49	12PKG-263226	49	13PK-320732-X	32	13PKS-320632OP	189
11PKS-403232	184	12PKG-324032	49	13PK-400540	32	13PKS-320732	185
11PKS-404032	184	12PKS-324032	184	13PK-400540-N	32	13PKS-320732-N	185
11PKS-503240	184	12PKS-405040	184	13PK-400540-X	32	13PKS-400440	185
11PKS-504040	184	12PKW-162016	42	13PK-400640	32	13PKS-400440-N	185
11PKW-201616	42	12PKW-202620	42	13PK-400640-N	32	13PKS-400640	185
11PKW-202016	42	12PKW-263226	42	13PK-400640-X	33	13PKS-400640-N	185
11PKW-261616	42	12SK-162016	70	13PK-400740	32	13PKS-400740	185
11PKW-261620	42	12SK-202620	70	13PK-400740-N	32	13PKS-400740-N	185
11PKW-262016	42	13-1415-2	103	13PK-400740-X	33	13PKS-500450	185
11PKW-262020	42	13-1615A-2	103	13PK-500550	32	13PKS-500450-N	185
11PKW-262616	42	13-1615HA-2	103	13PK-500550-N	32	13PKS-500550	185
11PKW-262620	42	13-2022HA-2	103	13PK-500550-X	33	13PKS-500550-N	185
11PKW-322026	42	13-2628H-2	103	13PK-500850	32	13PKS-500850	185
11PKW-322626	42	13P-160416	82	13PK-500850-N	32	13PKS-500850-N	185
11SK-201616	70	13P-200420	82	13PK-500850-X	33	13PKS-630463	185
11SK-202016	70	13P-200520	82	13PK-631063	32	13PKS-630463-N	185
11SK-261620	70	13P-260426	82	13PK-631063-N	32	13PKS-631063	185
11SK-262016	70	13P-260526	82	13PK-631063-X	33	13PKS-631063-N	185
11SK-262020	70	13P-320532	82	13PK-750675	63	13PKW-160416	43

Article	p.	Article	p.	Article	p.	Article	p.
13PKW-160416-N	43	14PK-400740	33	15PG-3232	98	16PK-2616	34
13PKW-160416-X	43	14PK-500850	33	15PK-1414	34	16PK-2618	34
13PKW-200420	43	14PK-500850-N	33	15PK-1616	34	16PK-2620	34
13PKW-200420-N	43	14PK-631063	33	15PK-1818	34	16PK-3216	34
13PKW-200420-X	43	14PK-751075	63	15PK-2020	34	16PK-3220	34
13PKW-200520	43	14PK-751075-N	64	15PK-2626	34	16PK-3226	34
13PKW-200520-N	43	14PK-751275	63	15PK-3232	34	16PK-4026	34
13PKW-200520-X	43	14PK-751275-N	64	15PK-4040	34	16PK-4032	34
13PKW-260426	43	14PKG-160416	50	15PK-5050	34	16PK-5032	34
13PKW-260426-N	43	14PKG-200420	50	15PK-6363	34	16PK-5040	34
13PKW-260426-X	43	14PKG-260426	50	15PK-7575	64	16PK-6340	34
13PKW-260526	43	14PKG-260626	50	15PK-9090	64	16PK-6350	34
13PKW-260526-N	43	14PKG-320532	50	15PKG-1616	50	16PK-7532	64
13PKW-260526-X	43	14PKS-320532	185	15PKG-2020	50	16PK-7540	64
13PKW-320532	43	14PKS-320532-N	186	15PKG-2626	50	16PK-7550	64
13PKW-320532-N	43	14PKS-400640	185	15PKG-3232	50	16PK-7563	64
13PKW-320532-X	43	14PKS-400640-N	186	15PKS-3232	186	16PK-9032	64
13PKW-320632	43	14PKS-400740	185	15PKS-4040	186	16PK-9040	64
13PKW-320632-N	43	14PKS-400740-N	186	15PKS-5050	186	16PK-9050	64
13PKW-320632-X	43	14PKS-500850	185	15PKS-6363	186	16PK-9063	64
13SK-160416BP	70	14PKS-500850-N	186	15PKW-1616	44	16PK-9075	64
13SK-200420BP	70	14PKS-631063	185	15PKW-2020	44	16PKG-2016	51
13SK-200520	70	14PKS-631063-N	186	15PKW-2626	44	16PKG-2616	51
13SK-260420BP	70	14PKW-160416	43	15PKW-3232	44	16PKG-2620	51
13SK-260426BP	70	14PKW-160416-N	44	15-R160212-KB	14	16PKG-3216	51
13SK-260526	70	14PKW-200420	43	16HNBA	56	16PKG-3220	51
13-V2622H-2	103	14PKW-200420-N	44	16P-2016	83	16PKG-3226	51
14P-160416	82	14PKW-200520	43	16P-2018	83	16PKS-4032	186
14P-200420	82	14PKW-200520-N	44	16P-2616	83	16PKS-5032	186
14P-200520	82	14PKW-320532	43	16P-2620	83	16PKS-5040	186
14P-260426	82	14SK-160416	70	16P-3216	83	16PKS-6340	186
14PK-160416	33	14SK-200420	70	16P-3220	83	16PKS-6350	186
14PK-180418	33	14SK-260426	70	16P-3226	83	16PKW-2016	44
14PK-200420	33	15P-1616	82	16PG-2016	98	16PKW-2616	44
14PK-200520	33	15P-1818	82	16PG-2620	98	16PKW-2620	44
14PK-260426	33	15P-2020	82	16PG-3226	98	16PKW-3216	44
14PK-260526	33	15P-2626	82	16PK-1614	34	16PKW-3220	44
14PK-260626	33	15P-3232	82	16PK-1814	34	16PKW-3226	44
14PK-320532	33	15PG-1616	98	16PK-1816	34	16SK-2016	71
14PK-400640	33	15PG-2020	98	16PK-2016	34	16SK-2616	71
14PK-400640-N	33	15PG-2626	98	16PK-2018	34	16SK-2620	71

Index

Article	p.	Article	p.	Article	p.	Article	p.
17HNA-06-X	57	17PK-2605	35	17PKW-2005-N	45	18P-1604	84
17HNA-07-X	57	17PK-2606	35	17PKW-2605	44	18P-1804	84
17HNA-08-X	57	17PK-3206	35	17PKW-2605-N	45	18P-2004	84
17HNA-10	57	17PK-3207	35	17PKW-2606	44	18P-2005	84
17HNA-10-N	57	17PK-4006	35	17PKW-2606-N	45	18P-2605	84
17HNA-10-X	57	17PK-4006-N	35	17PKW-3206	44	18P-2606	84
17HNA-12	57	17PK-4007	35	17PKW-3206-N	45	18P-3206	84
17HNA-12-N	57	17PK-4007-N	35	17PKW-3207	44	18P-3207	84
17HNA-12-X	57	17PK-5008	35	17PKW-3207-N	45	18PG-1604	99
17HNB-14	57	17PK-5008-N	35	17SK-1603	71	18PG-2004	99
17P-1603	83	17PK-6310	35	17SK-1604	71	18PG-2005	99
17P-1603DZR	83	17PK-6310-N	35	17SK-2004	71	18PG-2605	99
17P-1604	83	17PK-7510	64	17SK-2005	71	18PG-2606	99
17P-1604-CS	84	17PK-7510-N	65	17SK-2605	71	18PG-3206	99
17P-1604DZR	83	17PK-7512	64	17SK-2606	71	18PK-1404	35
17P-1605	83	17PK-7512-N	65	17SKS-2004	72	18PK-1404-X	36
17P-1804	83	17PKG-1604	51	17SKS-2004	113	18PK-1604	35
17P-1805	83	17PKG-2004	51	17SKS-2005	72	18PK-1604-X	36
17P-2004	83	17PKG-2005	51	17SKS-2005	113	18PK-1804	35
17P-2004-CS	84	17PKG-2605	51	17SKS-2604	72	18PK-1804-X	36
17P-2005	83	17PKG-2606	51	17SKS-2604	113	18PK-1805	35
17P-2005-CS	84	17PKG-3206	51	17SKS-2605	72	18PK-1805-X	36
17P-2605	83	17PKG-3207	51	17SKS-2605	113	18PK-2004	35
17P-2605-CS	84	17PKS-3206	186	17VBS-2005	122	18PK-2004-X	36
17P-2606	83	17PKS-3206-N	187	17VBS-2605	122	18PK-2005	35
17P-2606-CS	84	17PKS-3207	186	17VBS-2606	122	18PK-2005-X	36
17P-3206	83	17PKS-3207-N	187	18EK05-03	116	18PK-2605	35
17P-3207	83	17PKS-4006	186	18HNA-06	57	18PK-2605-X	36
17PG-1604	98	17PKS-4006-N	187	18HNA-06-N	58	18PK-2606	35
17PG-2004	98	17PKS-4007	186	18HNA-06-X	58	18PK-2606-X	36
17PG-2005	98	17PKS-4007-N	187	18HNA-08-X	58	18PK-3206	35
17PG-2605	98	17PKS-5008	186	18HNA-10	57	18PK-3206-X	36
17PG-2606	98	17PKS-5008-N	187	18HNA-10-N	58	18PK-3207	35
17PG-3206	98	17PKS-6310	186	18HNA-10-X	58	18PK-3207-X	36
17PK-1404	35	17PKS-6310-N	187	18HNA-12	57	18PK-4006	35
17PK-1604	35	17PKW-1604	44	18HNA-12-N	58	18PK-4006-N	36
17PK-1804	35	17PKW-1604-N	45	18HNA-12-X	58	18PK-4006-X	36
17PK-1805	35	17PKW-2004	44	18HNB-14	57	18PK-4007	35
17PK-2004	35	17PKW-2004-N	45	18HNB-14-N	58	18PK-4007-N	36
17PK-2005	35	17PKW-2005	44	18HNB-14-X	58	18PK-4007-X	36

Article	p.	Article	p.	Article	p.	Article	p.
18PK-5008	35	18PKW-2004-N	45	19PK-2005	11	25-ISO4-26-BL-BSD	9
18PK-5008-N	36	18PKW-2004-X	46	19PKW-1605	46	25-ISO4-26-RO	9
18PK-5008-X	36	18PKW-2005	45	19PKW-2005	46	25-ISO4-26-RO-BSD	9
18PK-6310	35	18PKW-2005-N	45	19SK-1505	72	25-ISO4-32-BL	9
18PK-6310-N	36	18PKW-2005-X	46	19SK-1505	113	25-ISO4-32-BL-BSD	9
18PK-6310-X	36	18PKW-2605	45	19SK-1605	66	25-ISO4-32-RO	9
18PK-7506	64	18PKW-2605-N	45	19SK-1605	72	25-ISO4-32-RO-BSD	9
18PK-7506-N	64	18PKW-2605-X	46	19SK-1605	113	25-ISO4-R16-BL-BSD	15
18PK-7510	64	18PKW-2606	45	19SK-2005	66	25-ISO4-R16-RO-BSD	15
18PK-7510-N	64	18PKW-2606-N	45	19SK-2005	72	25-ISO4-R26-BL	15
18PK-7512	64	18PKW-2606-X	46	19SK-2005	113	25-ISO4-R26-BL-BSD	15
18PK-7512-N	64	18PKW-3206	45	24-1615-S	104	25-ISO4-R26-RO	15
18PK-9014	64	18PKW-3206-N	45	24-2022	104	25-ISO4-R26-RO-BSD	15
18PK-9014-N	64	18PKW-3206-X	46	24-2622	104	25-ISO9-26-BL	10
18PKG-1604	51	18PKW-3207	45	24P-1604	85	25-ISO9-26-BL-BSD	10
18PKG-2004	51	18PKW-3207-N	45	24P-2004	85	25-ISO9-26-RO	10
18PKG-2005	51	18PKW-3207-X	46	25-016GASMG	23	25-ISO9-26-RO-BSD	10
18PKG-2605	51	18SK-1604	71	25-016MB	12	25-ISO9-32-BL	10
18PKG-2606	51	18SK-2004	71	25-016MB-KB	12	25-ISO9-32-BL-BSD	10
18PKG-3206	51	18SK-2005	71	25-016MR	12	25-ISO9-32-RO	10
18PKG-3207	51	18SK-2605	71	25-016MR-KB	12	25-ISO9-32-RO-BSD	10
18PKG-4007	51	18SK-2606	71	25-020GASMG	23	25-ISO9-R26-BL	16
18PKS-3204	187	18SKS-2004	72	25-020MB	12	25-ISO9-R26-BL-BSD	16
18PKS-3204-N	187	18SKS-2004	114	25-020MBLACK	12	25-ISO9-R26-RO	16
18PKS-3206	187	18SKS-2005	72	25-020MR	12	25-ISO9-R26-RO-BSD	16
18PKS-3206-N	187	18SKS-2005	114	25-026GASMG	23	25-ISO13-32-BL	11
18PKS-3206OP	189	18SKS-2604	72	25-026MB	12	25-ISO13-32-BL-BSD	11
18PKS-3207	187	18SKS-2604	114	25-026MR	12	25-ISO13-32-RO	11
18PKS-3207-N	187	18SKS-2605	72	25-032GASMG	23	25-ISO13-32-RO-BSD	11
18PKS-4006	187	18SKS-2605	114	25-032MB	12	25-ISO20-32-BL-BSD	11
18PKS-4006-N	187	19P-1405	84	25-032MR	12	25-ISO20-32-RO-BSD	11
18PKS-4007	187	19P-1605	84	25-160212-KB	7	25-ISO20-R26-BL	17
18PKS-4007-N	187	19P-1605	66	25-200216	7	25-ISO20-R26-BL-BSD	17
18PKS-5008	187	19P-1805	84	25-200216-KB	7	25-ISO20-R26-RO	17
18PKS-5008-N	187	19P-2005	66	25-260320	7	25-ISO20-R26-RO-BSD	17
18PKS-6310	187	19P-2005	84	25-320326	7	25-ISO20-R26-RO-BSD	17
18PKS-6310-N	187	19PK-1605	36	25-ISO4-16-BL	9	25-MB32	22
18PKW-1604	45	19PK-1605	66	25-ISO4-16-RO	9	25-MBLACK32	22
18PKW-1604-N	45	19PK-1605	111	25-ISO4-20-BL	9	25-MG32	22
18PKW-1604-X	46	19PK-2005	36	25-ISO4-20-RO	9	25-MR32	22
18PKW-2004	45	19PK-2005	66	25-ISO4-26-BL	9	25P-1604	85

Index

Article	p.	Article	p.	Article	p.	Article	p.
25-R16MB	18	27HNA	58	30PG-2622S	99	40P-2622S	90
25-R16MR	18	27HNB	58	31P-161616	89	41P-16	91
25-R20MB	18	27P-2626	86	31P-161620	89	41P-20	91
25-R20MBLACK	18	27P-3232	86	31P-201616	89	41P-26	91
25-R20MR	18	27PK-2626	37	31P-201620	89	42P-161615	91
25-R160212-KB	14	27PK-3232	37	31P-202020	89	42P-202019	91
25-R200216-KB	14	27PK-4040	37	33P-1605	89	43P-161516	91
25-R260320	14	27PK-5050	37	34P-1604	89	44P-1604	92
26P-16Z04	85	27PK-6363	37	34P-1605	89	45P-1604	92
26P-16Z04DZR	86	27PK-7575	65	34P-1605-CS	89	46P-2622P	92
26P-16Z05	85	27PK-9090	65	34P-2004	89	46P-3228P	92
26P-20Z04	85	27PKS-3232	188	34P-2004-CS	89	47P-25H26	92
26P-20Z04DZR	86	27PKS-4040	188	34P-2005	89	47P-20H20	92
26P-20Z05	85	27PKS-5050	188	34P-2005-CS	89	48P-202004	93
26P-20Z05DZR	86	27PKS-6363	188	34P-2605-CS	89	48P-262604	93
26P-26Z05	85	27PKW-2626	46	34P-3206	89	48P-323204	93
26P-26Z05DZR	86	27PKW-3232	46	35P-1615P	89	50-014MB	12
26P-26Z06	85	28P-14041604-1	86	35P-2022P	89	50-014MR	12
26P-32Z06	85	28P-16041604-1	86	36P-1612P	89	50-016GASMG	23
26P-32Z07	85	28PF-16041604	87	36P-1614P	89	50-016MB	12
26P-1604	85	28PF-20042004	87	36P-1615P	89	50-016MBLACK	12
26P-1605	85	28PK-04	37	36P-1616P	89	50-016MR	12
26P-2004	85	28PV-16031603-1	87	36P-2015P	89	50-018MB	12
26P-2005	85	28PV-16041604-1	87	36P-2018P	89	50-018MR	12
26P-2605	85	29P-1612-CS	87	36P-2022P	89	50-020GASMG	23
26P-2606	85	29P-1615	87	36P-2622P	89	50-020MB	12
26P-3206	85	29P-1615-CS	87	36P-2628P	89	50-020MBLACK	12
26PK-1605	37	29P-2015	87	36P-3228P	89	50-020MR	12
26PK-2005	37	29P-2018-CS	87	36PG-1615P	99	50-026GASMG	23
26PK-4007	37	29P-2022	87	36PG-2015P	99	50-026MB	12
26PK-4008	37	29P-2022-CS	87	36PG-2022P	99	50-026MBLACK	12
26PK-5008	37	29P-2622	87	36PG-2615P	99	50-026MR	12
26PK-5010	37	29P-2622-CS	87	36PG-2622P	99	50-160212	7
26PK-6310	37	29P-2628	87	37P-1412L	90	50-200216	7
26PK-6312	37	29P-3228	87	37P-1612L	90	50-260320	7
26PKW-1605	46	30P-1614S	88	37P-1615L	90	50-260320-GAS	23
26PKW-2005	46	30P-1615S-2	88	38P-2622P	90	50-320326	7
26SK-1605	72	30P-2022S	88	38P-3228P	90	50-320326-SPR	24
26SK-1605	113	30P-2622S	88	39P-160450	90	50-320326-SPR	197
26SK-2005	72	30PG-1615S-2	99	40P-1615S	90	50-COMBI16	13
26SK-2005	113	30PG-2022S	99	40P-2022S	90	50-COMBI16R	18

Article	p.	Article	p.	Article	p.	Article	p.
50-ISO4-16-BL	9	50-ISO9-16-BL	10	50-ISO13-26-BL	11	50P-320605	188
50-ISO4-16-BL-BSD	9	50-ISO9-16-BL-BSD	10	50-ISO13-26-BL-BSD	11	50-R16MB	18
50-ISO4-16-RO	9	50-ISO9-16-RO	10	50-ISO13-26-RO	11	50-R16MBLACK	18
50-ISO4-16-RO-BSD	9	50-ISO9-16-RO-BSD	10	50-ISO13-26-RO-BSD	11	50-R16MR	18
50-ISO4-18-BL	9	50-ISO9-18-BL	10	50-ISO13-R16-BL	16	50-R18MB	18
50-ISO4-18-BL-BSD	9	50-ISO9-18-BL-BSD	10	50-ISO13-R16-BL-BSD	17	50-R18MR	18
50-ISO4-18-RO	9	50-ISO9-18-RO	10	50-ISO13-R16-RO	16	50-R20MB	18
50-ISO4-18-RO-BSD	9	50-ISO9-18-RO-BSD	10	50-ISO13-R16-RO-BSD	17	50-R20MR	18
50-ISO4-20-BL	9	50-ISO9-20-BL	10	50-ISO13-R20-BL	16	50-R26MB	18
50-ISO4-20-BL-BSD	9	50-ISO9-20-BL-BSD	10	50-ISO13-R20-BL-BSD	17	50-R26MR	18
50-ISO4-20-RO	9	50-ISO9-20-RO	10	50-ISO13-R20-RO	16	50-R160212	14
50-ISO4-20-RO-BSD	9	50-ISO9-20-RO-BSD	10	50-ISO13-R20-RO-BSD	17	50-R200216	14
50-ISO4-26-BL	9	50-ISO9-26-BL	10	50-ISO13-R26-BL	16	50-R260320	14
50-ISO4-26-BL-BSD	9	50-ISO9-26-BL-BSD	10	50-ISO13-R26-BL-BSD	17	52P16	93
50-ISO4-26-RO	9	50-ISO9-26-RO	10	50-ISO13-R26-RO	16	52P20	93
50-ISO4-26-RO-BSD	9	50-ISO9-26-RO-BSD	10	50-ISO13-R26-RO-BSD	17	52P26	93
50-ISO4-32-BL	9	50-ISO9-32-BL	10	50-ISO20-R16-BL	17	52P32	93
50-ISO4-32-BL-BSD	9	50-ISO9-32-BL-BSD	10	50-ISO20-R16-BL-BSD	17	52PS32	188
50-ISO4-32-RO	9	50-ISO9-32-RO	10	50-ISO20-R16-RO	17	53HPK-16	76
50-ISO4-32-RO-BSD	9	50-ISO9-32-RO-BSD	10	50-ISO20-R16-RO-BSD	17	53HPK-20	76
50-ISO4-COMBI16R	18	50-ISO9-R16-BL	16	50-ISO20-R20-BL	17	53PK40	37
50-ISO4-R16-BL	15	50-ISO9-R16-BL-BSD	16	50-ISO20-R20-BL-BSD	17	53PK50	37
50-ISO4-R16-BL-BSD	15	50-ISO9-R16-RO	16	50-ISO20-R20-RO	17	53PK63	37
50-ISO4-R16-RO	15	50-ISO9-R16-RO-BSD	16	50-ISO20-R20-RO-BSD	17	53PKS40	188
50-ISO4-R16-RO-BSD	15	50-ISO9-R20-BL	16	50-ISO20-R20-RO-BSD	17	53PKS50	188
50-ISO4-R18-BL	15	50-ISO9-R20-BL-BSD	16	50-MB20	22	53PKS63	188
50-ISO4-R18-BL-BSD	15	50-ISO9-R20-RO	16	50-MB26	22	100-016MB	12
50-ISO4-R18-RO	15	50-ISO9-R20-RO-BSD	16	50-MBLACK20	22	100-016MBLACK	12
50-ISO4-R18-RO-BSD	15	50-ISO9-R26-BL	16	50-MBLACK26	22	100-016MR	12
50-ISO4-R20-BL	15	50-ISO9-R26-BL-BSD	16	50-MG16	22	100-018MB	12
50-ISO4-R20-BL-BSD	15	50-ISO9-R26-RO	16	50-MG20	22	100-018MR	12
50-ISO4-R20-RO	15	50-ISO9-R26-RO-BSD	16	50-MG26	22	100-020MB	12
50-ISO4-R20-RO-BSD	15	50-ISO13-16-BL	11	50-MR20	22	100-020MR	12
50-ISO4-R26-BL	15	50-ISO13-16-BL-BSD	11	50-MR26	22	100-121688	7
50-ISO4-R26-BL-BSD	15	50-ISO13-16-RO	11	50-MXC1620	20	100-140210	7
50-ISO4-R26-RO	15	50-ISO13-16-RO-BSD	11	50-MXC1620	66	100-160212	7
50-ISO4-R26-RO-BSD	15	50-ISO13-18-BL	11	50P43-320604	188	100-180214	7
50-ISO9-14-BL	10	50-ISO13-20-BL	11	50P-3206	188	100-200216	7
50-ISO9-14-BL-BSD	10	50-ISO13-20-BL-BSD	11	50P-320604	188	100-F16R-WZ	19
50-ISO9-14-RO	10	50-ISO13-20-RO	11			100-F20R-WZ	19
50-ISO9-14-RO-BSD	10	50-ISO13-20-RO-BSD	11			100-ISO4-14-BL	9

Index

Article	p.	Article	p.	Article	p.	Article	p.
100-ISO4-14-BL-BSD	9	500-160212	7	BAP-H2626	125	BE16MINI3	169
100-ISO4-14-RO	9	500-F16R-WZ	19	BAP-H3232	125	BE16MINI-RMS	171
100-ISO4-14-RO-BSD	9	600-PRT1420	21	BAP-SK1616	126	BE17	163
100-ISO4-16-BL	9	600-PRT1720	21	BAP-SK2020	126	BE18	163
100-ISO4-16-BL-BSD	9	600-PRT1820	21	BAP-SK2626	126	BE18C	170
100-ISO4-16-RO	9	600-PRT2020	21	BAP-SV1610S	125	BE18H	165
100-ISO4-16-RO-BSD	9	600-PXC1620	20	BCLIP-16	178	BE18H	168
100-ISO4-20-BL	9	600-PXC1720	20	BCLIP-26	178	BE18HC	165
100-ISO4-20-BL-BSD	9	600-PXC2020	20	BCLIP-32	178	BE18HC	168
100-ISO4-20-RO	9	640-PRT1620	21	BCLIP-40	178	BE18HM	166
100-ISO4-20-RO-BSD	9	AB1420	105	BCLIP-50	178	BE18HM	169
100-ISO4-R16-BL	15	AD-EKEK	105	BCLIP-1820	178	BE18M	172
100-ISO4-R16-BL-BSD	15	AK-EK05VD	180	BDB33M	180	BE18M-MINI3	169
100-ISO4-R16-RO	15	AN1420	106	BDR33M	180	BE18V-MINI3	169
100-ISO4-R16-RO-BSD	15	AT1420	105	BE12HC	165	BE20	163
100-MB	22	BA-1288	158	BE12HC	168	BE20H	165
100-MBLACK	22	BA-1410	158	BE12HM	166	BE20H	168
100-MG16	22	BA-1612	158	BE12HM	169	BE20M	172
100-MR	22	BA-1814	158	BE12M-MINI3	169	BE20MINI	170
100-R16MB	18	BA-2016	158	BE14	163	BE20MINI3	169
100-R16MBLACK	18	BA-F41	125	BE14H	165	BE20MINI-RMS	171
100-R16MR	18	BAP-FFV16Z05	124	BE14H	168	BE22C	170
100-R20MB	18	BAP-FFV20Z05	124	BE14HC	165	BE22HC	165
100-R20MR	18	BAP-FFV26Z05	124	BE14HC	168	BE22HC	168
100-R160212	14	BAP-FFV26Z06	124	BE14M	172	BE22HM	166
100-R180214	14	BAP-FFV32Z06	124	BE14MINI3	169	BE22HM	169
100-R200216	14	BAP-FFV1604	124	BE15C	170	BE22MMINI	170
120-PRT1620	21	BAP-FFV1605EK	124	BE15HC	165	BE22M-MINI3	169
200-121688	7	BAP-FFV1616	124	BE15HC	168	BE22V-MINI3	169
200-140210	7	BAP-FFV1805	124	BE15HM	166	BE25H	165
200-160212	7	BAP-FFV2005	124	BE15HM	169	BE25H	168
200-180214	7	BAP-FFV2005EK	124	BE15MMINI	170	BE25MINI3	169
200-F16R-WZ	19	BAP-FFV2020	124	BE15M-MINI3	169	BE26	163
200-PXC1620	20	BAP-FFV2605	124	BE15V-MINI3	169	BE26H	165
200-PXC1720	20	BAP-FFV2605EK	124	BE16	163	BE26H	168
200-PXC2020	20	BAP-FFV2606	124	BE16H	165	BE26MINI	170
200-R160212	14	BAP-FFV2626	124	BE16H	168	BE26MINI3	169
200-R180214	14	BAP-FFV3207	124	BE16HC	165	BE26MINI-RMS	171
240-PRT1820	21	BAP-FFV3232	124	BE16HC	168	BE28C	170
240-PXC1820	20	BAP-H1616	125	BE16M	172	BE28HC	165
270-PRT1620	21	BAP-H2020	125	BE16MINI	170	BE28HC	168

Article	p.	Article	p.	Article	p.	Article	p.
BE28M-MINI3	169	CU-ANTRF	150	HNTOOLSET	172	M-BOXMINI2	172
BE28V-MINI3	169	CU-ATHERMB-H	148	HPK-BK16	76	M-BOXMINI3	167
BE32	163	CU-ATHERMB-HC	148	HSM-VALVE-0505	128	M-BOXMINI3-F	168
BE32H	165	CU-ATHERMRF-HC	150	HSM-DETECTOR	128	M-HP32	172
BE32H	168	CU-DTHERMB-HC	148	HSM-SENSOR	128	M-LADO3	162
BE32MINI	170	CU-DTHERMB-HC-B	148	IM63	159	M-LADMINI3	167
BE32MINI3	169	CU-DTHERMRF-HC	150	IM1426PRESS	159	M-TRANSO3	162
BE32MINI-RMS	171	CU-DTHERMRF-HC-B	150	IM1426PRESS-N	159	M-TRANSMINI2	172
BE40	1 6 3	CU-RADTHERMRF	151	IMEM63	159	M-TRANSMINI3	167
BE50	1 6 3	CU-REPRF	151	IMEM1426-PRESS	159	N04	86
BE63	1 6 3	CU-ZONERF-HC	149	ISO-BLOCK-S	13	N05	86
BE-BOX	166	DRILLY14	173	ISO-BOX	88	N06	86
BE-MINI	171	DRILLY16	173	JCLIP-1632D	178	N0404-X	86
BE-MINI3	168	DRILLY20	173	KS12M	161	N0505-X	86
BE-UNI	165	EK12-2	104	KS14M	161	N0606-X	86
BE-UNISSET1	163	EK14-2	104	KS16M	161	PH-1632	174
BE-UNISSET2	164	EK15	104	KS18M	161	PIPEPLUG16	178
BE-UNISSETMINI3	164	EK15	126	KS20M	161	PIPEPLUG20	178
BI-1410	158	EK16-2	104	KS26M	161	PIPEPLUG26	178
BI-1612	158	EK17-2	104	KS32M	161	PK-TOOLO4	175
BI-1612L	158	EK18-2	104	KS40M	161	PK-TOOLO5	175
BI-1814	158	EK20-2	104	KS50	160	PK-TOOLO6	175
BI-2016	158	ENDCAP-EK05	115	KS63	160	PK-TOOLO7	175
BI-2016L	158	ENDCAP-EK05-BLACK	111	KS-K	161	PK-TOOLO8	175
BI-2620	158	H-0212	122	KS-MSET1	160	PK-TOOL10	175
BM-16	158	H-0212-C	122	KS-MSET3	160	PK-TOOLBOX	175
BM-16F	158	HFMAN125	180	KS-MSET4	160	PK-TOOLBOX-040506	175
BM-18	158	HNA	58	KS-P162026	161	PLF-P-PK	179
BM-20	158	HNA-COMP	60	LB50	13	PLP-P-PK	179
BM-20F	158	HNA-CR	59	M-BA03	162	PLUG04-B80	173
BM-26	158	HNA-ECOLINE-SET	66	M-BAT03	162	PLUG04-R80	173
BPO4	28	HNA-EK05-E	60	M-BATMINI2	170	PLUG05-B80	173
CU-6ZONEB-H	147	HNAFL-DN50	60	M-BATMINI3-2.OAH	167	PLUG05-R80	173
CU-6ZONEB-HC	147	HNA-INLB-E	60	M-BATMINI3-5.OAH	167	P-PIPESTOP16	94
CU-6ZONE-CON	147	HNA-STOP	59	M-BH162026	171	P-PIPESTOP20	94
CU-6ZONERF-HC	149	HNA-STOP-E	59	M-BHY162026	162	P-PIPESTOP26	94
CU-10ZONERF-HC	149	HNA-U	59	M-BM1620	172	P-PIPESTOP32	94
CU-ACT-B24V	152	HNB	58	M-BMINI3	166	PRESSCHECK1432	173
CU-ACT-B24V	148	HNB-STOP	59	M-BMINI3-F	166	PS-16	174
CU-ACT-B230V	152	HNB-U	59	M-BMINI3-S	167	PS-20	174
CU-ACT-B230V	148	HN-PEN	59	M-BOXBA03	162	RADO4-100V	126

Index

Article	p.	Article	p.	Article	p.	Article	p.
RADNI-0504	126	TESTPLUG20	179	UFH-0505SSTE09-PN6	138	UFH-0605MDK05-PRM-BV	140
RADTH-VL	126	TESTPLUG20-RO	179	UFH-0505SSTE10-PN6	138	UFH-0605MDK06-03L	139
RS32	159	TESTPLUG26	179	UFH-0505SSTE11-PN6	138	UFH-0605MDK06-03LPRM	139
SK-B05	74	TESTPLUG26-RO	179	UFH-0505SSTE12-PN6	138	UFH-0605MDK06-PRM-BV	140
SK-PIESTOP16	73	TOOLBOX405063	164	UFH-0605CD01	137	UFH-0605MDK07-03L	139
SK-PIESTOP20	73	TOOLBOX16202632	164	UFH-0605CD02	137	UFH-0605MDK07-03LPRM	139
SK-PIESTOP26	73	UFH-0405CDP01	137	UFH-0605CD03	137	UFH-0605MDK07-PRM-BV	140
SK-STOPCLIP16	73	UFH-0405CDP02	137	UFH-0605CD04	137	UFH-0605MDK07-03LPRM	139
SK-STOPCLIP16	115	UFH-0405CDP03	137	UFH-0605CD05	137	UFH-0605MDK07-PRM-BV	140
SK-STOPCLIP20	73	UFH-0405CDP04	137	UFH-0605CD06	137	UFH-0605MDK08-03L	139
SK-STOPCLIP20	115	UFH-0405CDP05	137	UFH-0605CD07	137	UFH-0605MDK08-03LPRM	139
SK-STOPCLIP26	73	UFH-0405CDP06	137	UFH-0605CD09	137	UFH-0605MDK08-PRM-BV	140
SK-STOPCLIP26	115	UFH-0405SLT01	138	UFH-0605CD10	137	UFH-0605MDK08-03LPRM	139
SPLIT14	104	UFH-0405SLT02	138	UFH-0605CD11	137	UFH-0605MDK09-03L	139
SPLIT16	104	UFH-0405SLT03	138	UFH-0605CD12	137	UFH-0605MDK09-03LPRM	139
SPLIT20	104	UFH-0405SLT04	138	UFH-0605CD13	137	UFH-0605MDK09-PRM-BV	140
SPLIT-S16	105	UFH-0405SLT05	138	UFH-0605CD14	137	UFH-0605MDK09-03LPRM	139
SPLIT-S20	105	UFH-0405SLT06	138	UFH-0605CD15	137	UFH-0605MDK09-PRM-BV	140
SPLIT-S26	105	UFH-0405SSTE03-PN6	138	UFH-0605CD16	137	UFH-0605MDK10-03L	139
SPR-CBLOCK	189	UFH-0405SSTE05-PN6	138	UFH-0605CD17	137	UFH-0605MDK10-03LPRM	139
SPR-CBLOCK80	189	UFH-0405SSTE06-PN6	138	UFH-0605CD18	137	UFH-0605MDK10-03LPRM	140
SPR-FIXSCREW	190	UFH-0505CDP07	137	UFH-0605CD19	137	UFH-0605MDK10-PRM-BV	140
SPR-ISO	190	UFH-0505CDP08	137	UFH-0605CD20	137	UFH-0605MDK11-03L	139
SPR-MAGNET31	190	UFH-0505CDP09	137	UFH-0605MDK02-03LPRM	139	UFH-0605MDK11-03LPRM	139
SPR-NO604IDL00H15	190	UFH-0505CDP10	137	UFH-0605MDK02-PRM-BV	140	UFH-0605MDK11-PRM-BV	140
SPR-NO604IDL05H20	190	UFH-0505CDP11	137	UFH-0605MDK03-03L	139	UFH-0605MDK12-03L	139
SPR-NO604IDL10H25	190	UFH-0505CDP12	137	UFH-0605MDK03-03LPRM	139	UFH-0605MDK12-03LPRM	139
SPR-NO604IDL15H30	190	UFH-0505CDP13	137	UFH-0605MDK03-PRM-BV	140	UFH-0605MDK12-PRM-BV	140
SPR-NO604IDL20H35	190	UFH-0505CDP14	137	UFH-0605MDK04-03L	139	UFH-0605MDSS02	141
SPR-NO604IDL25H40	190	UFH-0505CDP15	137	UFH-0605MDK04-03LPRM	139	UFH-0605MDSS03	141
SPR-NO604IDL30H45	190	UFH-0505CDP16	137	UFH-0605MDK04-PRM-BV	140	UFH-0605MDSS04	141
SPR-NO604IDLXXH00	190	UFH-0505SLT09	138	UFH-0605MDK05-03L	139	UFH-0605MDSS05	141
SPR-NO604IDLXXH05	190	UFH-0505SLT11	138	UFH-0605MDK05-03LPRM	139	UFH-0605MDSS06	141
SPR-NO604IDLXXH10	190	UFH-0505SLT12	138	UFH-0605MDK05-PRM-BV	139	UFH-0605MDSS07	141
SPR-OP06	189	UFH-0505SLT14	138	UFH-0605MDK05-03LPRM	139	UFH-0605MDSS08	141
SPR-PLUGTOOL	189	UFH-0505SLT15	138	UFH-0605MDK05-PRM-BV	140		
SS2PK04	180	UFH-0505SLT16	138	UFH-0605MDK05-03L	139		
SS3P04	180	UFH-0505SSTE07-PN6	138	UFH-0605MDK05-03LPRM	139		
TESTPLUG16	179	UFH-0505SSTE08-PN6	138				
TESTPLUG16-RO	179						

Article	p.	Article	p.	Article	p.	Article	p.
UFH-0605MDSS09	141	UFH-CAB-1965	156	UFH-ELEC-2250W	153	UFH-RAS-CUT	176
UFH-0605MDSS10	141	UFH-CAB-O385	156	UFH-ELEC-2250W-KIT	153	UFH-RAS-RB3	131
UFH-0605MDSS11	141	UFH-CAB-O385Z	156	UFH-ELEC-3000W	153	UFH-RAS-VLE	176
UFH-0605MDSS12	141	UFH-CAB-O400	156	UFH-ELEC-3000W-KIT	153	UFH-SCOTCH-66	132
UFH-0605MDSS13	141	UFH-CAB-O615	156	UFH-ELEC-THERM-B	154	UFH-TACK	176
UFH-0605MDSS14	141	UFH-CAB-O615Z	156	UFH-ELEC-THERM-W	154	UFH-TACK-38K	131
UFH-0605MDSS15	141	UFH-CAB-O800	156	UFH-ESK060303-M	143	UFH-TACK-40	132
UFH-060502-MD	142	UFH-CAB-O1015	156	UFH-ESK060303-VN	144	UFH-TACK-60	132
UFH-060503-MD	142	UFH-CAB-O1015Z	156	UFH-FOIL50	135	UFH-TACK-KLS20	131
UFH-060504-MD	142	UFH-CMDK03	140	UFH-FOIL90	135	UFH-TACK-KLS25	131
UFH-060505-MD	142	UFH-CMDSS03	141	UFH-FOIL-ALU	135	UFH-TACK-KLS30	131
UFH-060506-MD	142	UFH-CP	138	UFH-FOIL-CLIP25	135	UFH-TACK-KLS40	131
UFH-060507-MD	142	UFH-DH40	136	UFH-FOIL-N	135	UFH-TM050-M	144
UFH-060508-MD	142	UFH-DRY-1617-150F	132	UFH-GKT	143	UFH-UP-12	134
UFH-060509-MD	142	UFH-DRY-1617-200F	132	UFH-ISOBOARD-GV	136	UFH-UP-14M1	134
UFH-060510-MD	142	UFH-DRY-1625-100F	132	UFH-ISOBOARD-GVNL	136	UFH-UP-16	134
UFH-060511-MD	142	UFH-DRY-1625-100C	133	UFH-ISOBOARD-S	136	UFH-UP-16M1	134
UFH-060512-MD	142	UFH-DRY-1625-150C	133	UFH-ISODRY-25	134	UFH-UP-CUP50	135
UFH-ADN10	136	UFH-DRY-1625-100NF	133	UFH-ISOPRO11	130	UFH-VLA	176
UFH-ANC-05	147	UFH-DRY-1625-150F	132	UFH-ISOPRO30	130	UFH-VLA-STR	176
UFH-ANC-06	147	UFH-DRY-1625-150NF	133	UFH-M-D	142	UFH-VLA-STRHO	176
UFH-AO03-MZ	144	UFH-DRY-1625-200F	132	UFH-MDK-AO	140	UFH-WMZS-0606	144
UFH-B0606-M	143	UFH-DRY-1630-150F	132	UFH-MDK-CON	140	UFH-WMZS-0606-WR	144
UFH-B0606-VN	145	UFH-DRY-FTAPE	133	UFH-MDK-CON90	140	V-050404-Z	120
UFH-BEND20	136	UFH-DRY-GP100/2	134	UFH-P18-GP10	133	V-060402	120
UFH-BEND1218	136	UFH-ELEC-150W-KIT	153	UFH-P18-GP18	133	V-060404	120
UFH-BM0606-VN	145	UFH-ELEC-225W-KIT	153	UFH-P18-GP18V	133	V-060405	120
UFH-BMH0606T-VN	145	UFH-ELEC-300W-KIT	153	UFH-P18-WN	134	V-060406	120
UFH-BMH0606-VN	145	UFH-ELEC-375W-KIT	153	UFH-PG03	146	VB050502-BLAUW	117
UFH-BS05-M	144	UFH-ELEC-450W-KIT	153	UFH-PGKTA-K	142	VB050502-ROOD	117
UFH-BTM0606-M	143	UFH-ELEC-525W-KIT	153	UFH-PGKTA-K-T	142	VB050503-BLAUW	117
UFH-C191800	146	UFH-ELEC-600W-KIT	153	UFH-PLUG80	135	VB050503-ROOD	117
UFH-C191974	146	UFH-ELEC-675W-KIT	153	UFH-PRO	130	VB050504-BLAUW	117
UFH-C191976	146	UFH-ELEC-750W-KIT	153	UFH-RAS10	130	VB050504-ROOD	117
UFH-C192071	146	UFH-ELEC-900W-KIT	153	UFH-RAS15	130	VB060502-BLAUW	117
UFH-C260003001	145	UFH-ELEC-1050W-KIT	153	UFH-RAS20	130	VB060502-ROOD	117
UFH-C77249	143	UFH-ELEC-1200W-KIT	153	UFH-RAS-BIND15A	131	VB060503-BLAUW	117
UFH-CAB-I400	156	UFH-ELEC-1350W-KIT	153	UFH-RAS-BIND15B	131	VB060503-ROOD	117
UFH-CAB-I455	156	UFH-ELEC-1500W-KIT	153	UFH-RAS-CLIP16	131	VB060504-BLAUW	117
UFH-CAB-I565	156	UFH-ELEC-1800W	153	UFH-RAS-CLIP18	131	VB060504-ROOD	117
UFH-CAB-I715	156	UFH-ELEC-1800W-KIT	153	UFH-RAS-CLIP20	131	VB-EK05	121

Index

Article	p.	Article	p.	Article	p.
VB-EK05	125	VEK-060510-Z	120	VVPK-26	116
VB-HANDLE-BLUE	121	VISION-KEY16	73	VVPK90-20-D	116
VB-HANDLE-RED	121	VISION-KEY20	73	VVPK90-20-U	116
VBS-05	121	VISION-KEY26	73	VVPK90-26-D	116
VBS-05F	121	VKEK-B05	110	VVPK90-26-U	116
VBS-06	121	VKEK-ENDCAP-F	110	VVSK-20	113
VBS-06F	121	VKEK-ENDCAP-M	110	VVSK-20-90	114
VBS050502-BL	118	VKEK-T05	110	VVSK-26	113
VBS050502-GR	118	VKEK-V-IPO-BLACK	109	VVSK-26-90	114
VBS050502-RO	118	VKEK-V-IPO-BLUE	109	VVSK-T20M20	113
VBS050503-BL	118	VKEK-V-IPO-GREEN	109	VVSK-T26M26	113
VBS050503-GR	118	VKEK-V-IPO-RED	109	VVSK-T202020	114
VBS050503-RO	118	VKEK-V-2P-BLACK	109	WBP-1604	93
VBS050504-BL	118	VKEK-V-2P-BLUE	109	WBP-1604-BL	93
VBS050504-GR	118	VKEK-V-2P-GREEN	109	WBP-1604-RO	93
VBS050504-RO	118	VKEK-V-2P-RED	109	WBP-2004	93
VBS060502-BL	119	VKEK-V-3P-BLACK	109	WBP-2004-BL	93
VBS060502-RO	119	VKEK-V-3P-BLUE	109	WBP-2004-RO	93
VBS060503-BL	119	VKEK-V-3P-GREEN	109	WBPL-X	93
VBS060503-RO	119	VKEK-V-3P-RED	109	WBPL-X	106
VBS060504-BL	119	VKPK-20	111	WBS-1604	106
VBS060504-RO	119	VKPK-26	111	WBS-1604-BL	106
VBS-HANDLE-BLUE	121	VKPK-32	111	WBS-1604-RO	106
VBS-HANDLE-GREEN	121	VKPK-20-D	111		
VBS-HANDLE-RED	121	VKPK-26-D	111		
VDEK-T05	115	VKPK-20-U	111		
VDSK-20	115	VKPK-26-U	111		
VDSK-26	115	VS-05	122		
VEK-060502	120	VS-06	122		
VEK-060502-Z	120	VS-07	122		
VEK-060503	120	VS-0504	122		
VEK-060503-Z	120	VS-0604	122		
VEK-060504	120	VS-0605	122		
VEK-060504-Z	120	VS-ENDCAP	114		
VEK-060505	120	VS-ENDCAP-M	115		
VEK-060505-Z	120	VSK-1616	74		
VEK-060506-Z	120	VSK-161616	74		
VEK-060507-Z	120	VSKEK-0502	112		
VEK-060508	120	VSKEK-0503	112		
VEK-060508-Z	120	VSKEK-ISO-12	112		
VEK-060509-Z	120	VVPK-20	116		

The MyHenco platform is the perfect fit.

MyHenco, a digital assistant that is always within reach & available 24/7. More than just an online catalogue. Designed with a dynamic and user-friendly platform. MyHenco allows a personalised dashboard, features support articles and video's and helps to answer any queries our professionals may have.

Sign up to MyHenco at MyHenco.com

