

Heat recovery units

Cleva

One step further. More Cleva.



One step further. More Cleva.

In most buildings, floor space is limited, making it necessary to use a heat recovery solution that can be installed in the false ceiling.

Our new Cleva heat recovery units are a cost-effective solution that achieves comfortable indoor climate in a compact space.

Cleva offers high energy efficiency and low noise levels without compromising on performance. Thanks to its compact design it is ideal for commercial premises, offices or schools.



systemair | cleva

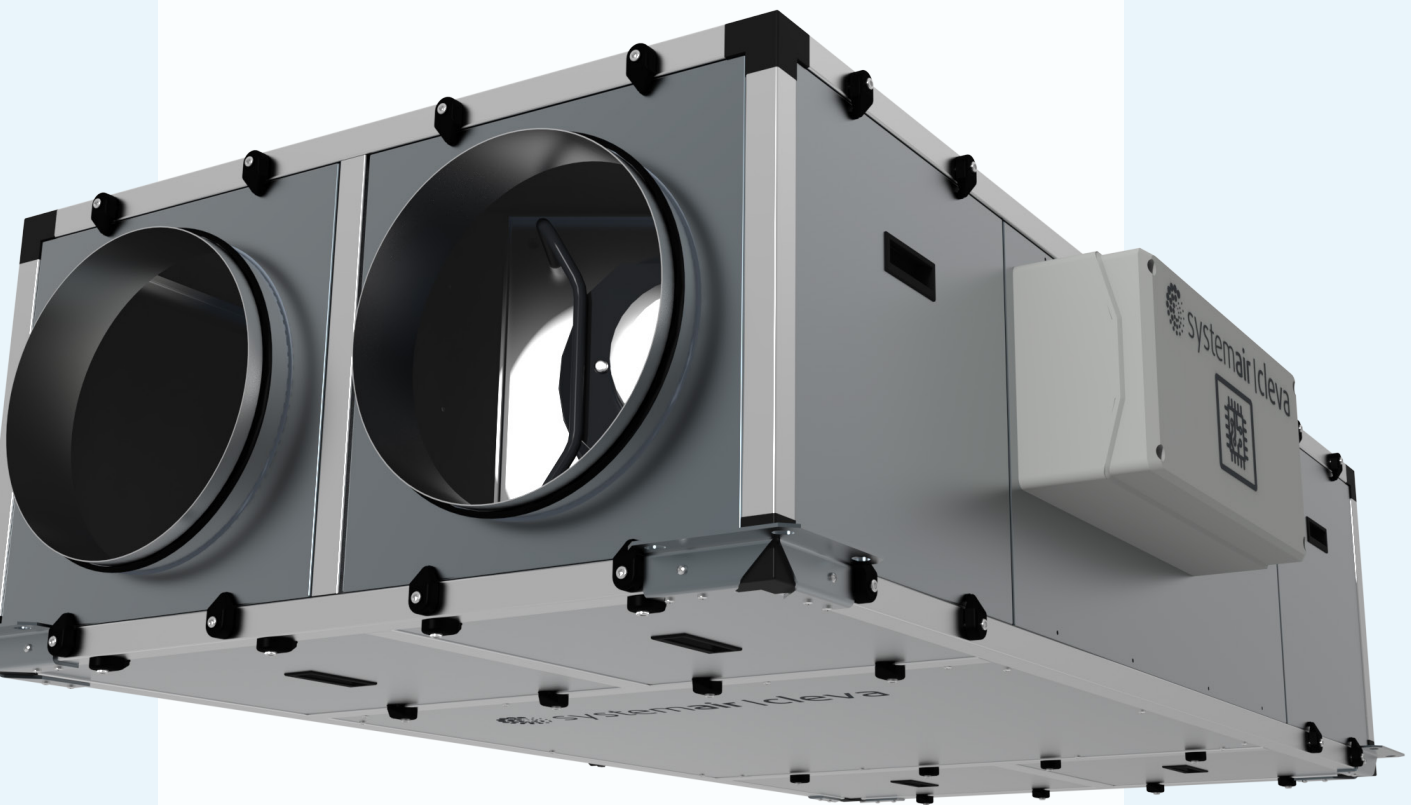

REDEFINED. Our heat recovery solution, now improved.

MORE CLEVER. Fully optimised and manufactured in Spain.

READY. We have a large stock available so you can receive your unit as soon as you request it.

Cleva at a glance

Compact dimensions and energy efficiency

The heat recovery units in the Cleva range are highly efficient. This is because they include a plate heat exchanger that offers a high level of air tightness. This result in an efficiency of up to 83% and low pressure drop, thus ensuring minimum electricity consumption.

- 6 sizes.
- Flow rates: 500 - 4,500 m³/h.
- C5 corrosion resistance panels according to ISO 12944 and to ISO 9223.
- Integrated control.
- Indoor or outdoor installation.
- Reduced height.
- Interchangeable panels allowing different air inlet and outlet configurations.
- Design for easy maintenance.

1 Condensate outlet

The lateral drainage helps reduce the actual installation height of the equipment.

2 Filtration

As an accessory/option, additional filters can be installed in both the return and supply air flow. A filter module can also be installed externally to the unit.

Filters are accessible from the bottom, side, and front.

Filter combination

Supply air	Exhaust air
ePM10 60% (M5) + ePM1 55% (F7)	ePM10 60% (M5)
ePM10 70% (M6) + ePM1 70% (F8)	ePM10 70% (M6)





3

3 EC Fans

EC fans with backward curved impellers and integrated electronic protection for possible voltage variations and reduced SFP values. The fans are supplied with 230V/I/50 Hz and 400V/III/50 Hz power supply and IP 54/55 depending on the model.

The fans are accessible from the bottom and side of the unit.

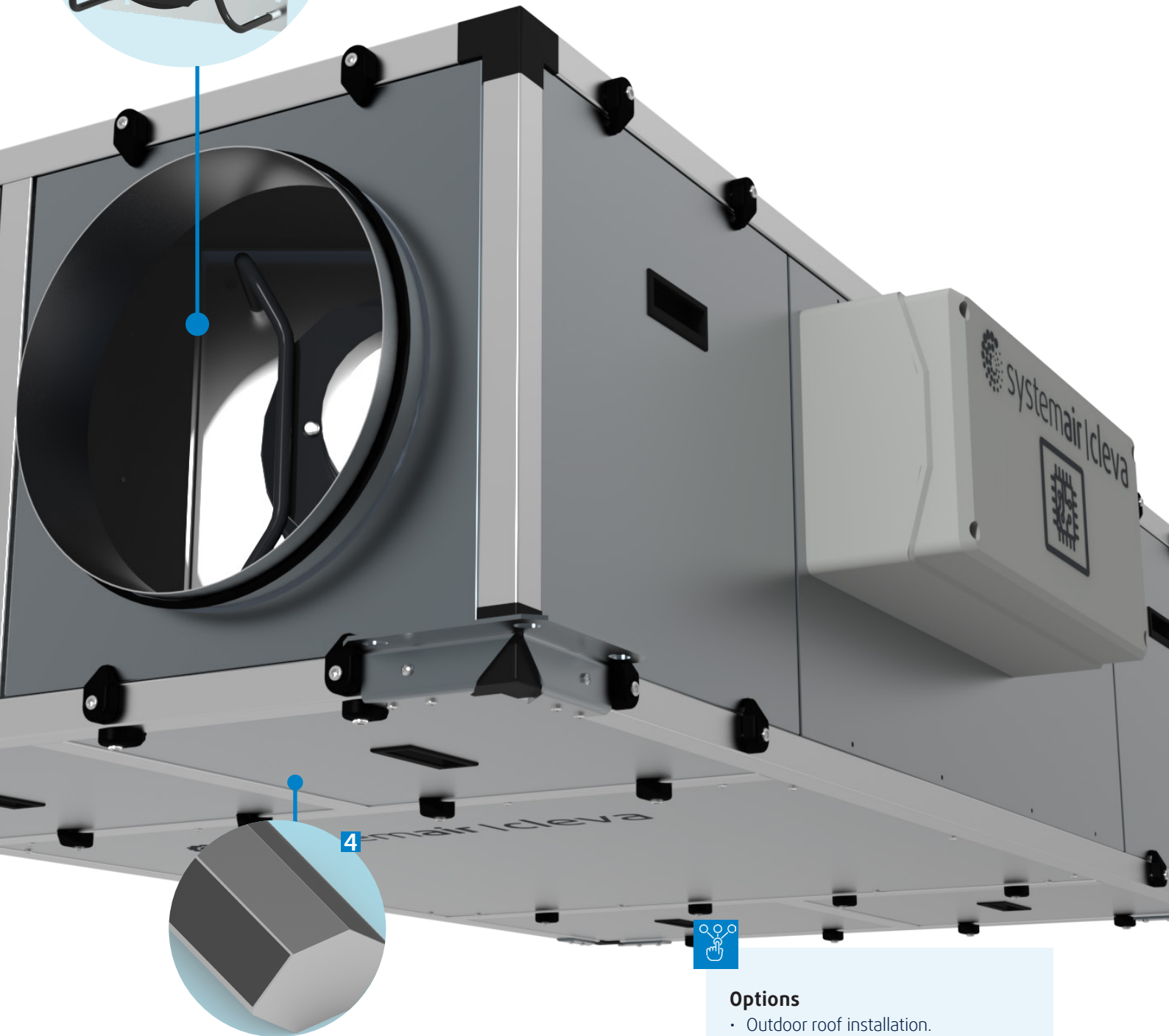

4

4 Heat recovery

Exclusive fin design to guarantee high performance and low pressure drop across the heat recovery. Plates are joined by means of a double fin to guarantee high levels of sealing.



Options

- Outdoor roof installation.
- Brackets for false ceiling or elevated floor installation.
- Duct-mounted coils for heating and cooling, available for chilled/hot water and DX systems.
- Duct electric heater.

Our selector

Easily choose your unit

The Cleva selector makes it easy to select, design, and configure your heat recovery units. Its intuitive interface helps you quickly choose the right Cleva unit by simply entering the operating points.

Based on your input, the Cleva configurator calculates all relevant project-specific parameters to find the optimal Cleva configuration.

Once your selection is complete, you can save the configurator's results as a PDF.

 systemair | cleva

Supply airflow

400 m³/h

Extract airflow

400 m³/h

Outdoor air temperature

-5°C

Extract air temperature

20°C

Cooling mode

Additional settings

Access the selector



<https://www.systemair.com/es-es/productos/selection-software/cleva-selection-tool>



BIM Models Available

Cleva's BIM models are now available for use in Revit. You can download them by scanning the code.



Supply external pressure

100 Pa

Extract external pressure

100 Pa

Outdoor air relative humidity

80%

Extract air relative humidity

50%

Control system

Simplifying connection, configuration and control

Cleva units are equipped with an electrical panel incorporated in the unit with IP65 protection and a controller for the management of all the components that make up the unit.

Control of the free-cooling damper

The free-cooling/free-heating damper will open when the outside air temperature is lower/greater than the return air temperature depending on the defined set-point.

Remote On/Off

It can be switched on or off remotely via a digital input (DI), BMS or from the control unit.

Two-speed selection

With Cleva, you can choose between two speeds: Normal (Nominal Mode) and Low (Reduced Mode), so it adapts to your needs.

Dirty filter pressure switch

In case of clogging of the air filters, the control unit will warn of the need to replace them.

Easy to use

The display shows all the necessary information about the unit's operation and makes it very easy to access the control parameters, both for start-up and day-to-day use.

BMS Connection

Provides a simplified setup for BMS connection via Modbus RTU - TCP/IP and BACnet MS/TP - IP communication.

Probe reading

The control system allows to read the sensors that measure the outdoor air, return air, and supply air temperatures.

CLEVA
CONTROL



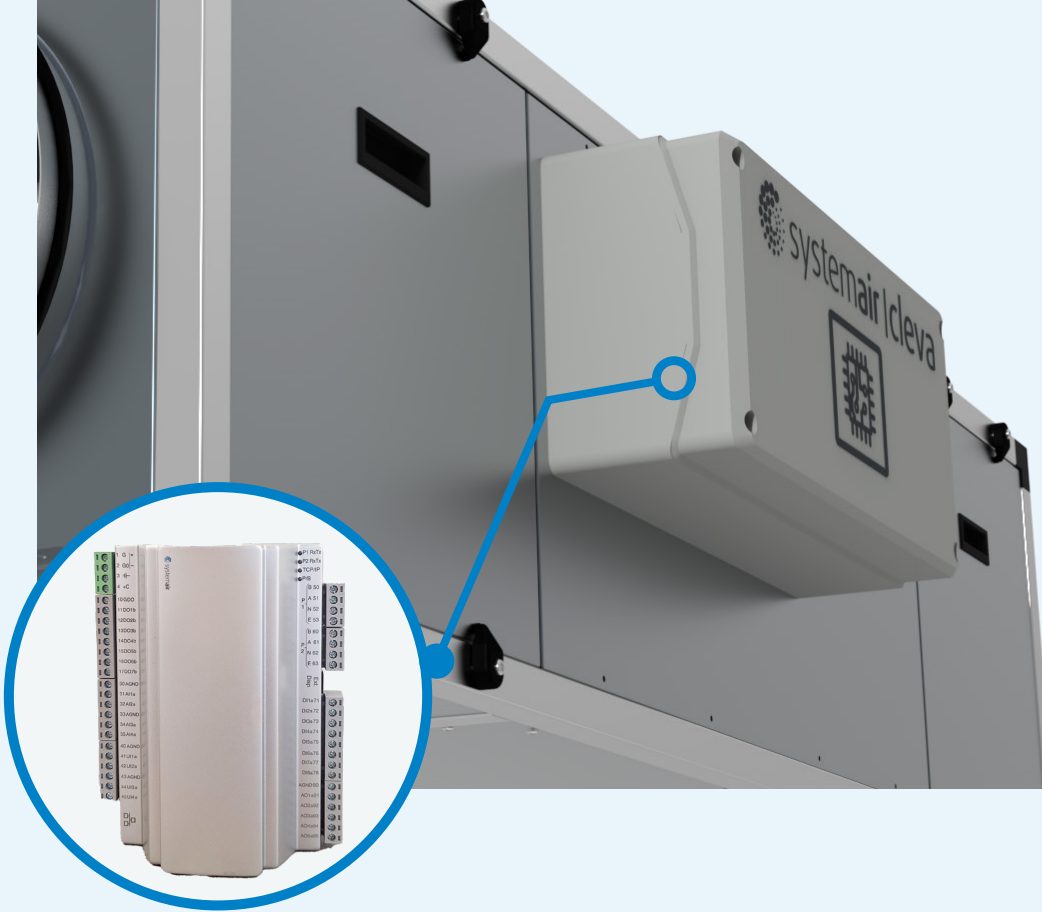

Options

- Constant airflow control on both airflows.
- Constant pressure control on both airflows.
- Airflow control via CO₂ sensor.
- Pressure switch for an additional filter stage in the supply airflow.
- Control based on supply or return air temperature (cascade).
- Cooling, heating, or combined cooling/heating stage regulation (water or DX). 0–10V output. Actuators and valves not supplied.
- Control signal for managing external dampers (outdoor air and exhaust air).
- Preheater on the outdoor air intake side to reduce the risk of the heat recovery unit freezing.
- Room-mounted control unit with the following functions:
 - Change of operating modes.
 - Setpoint adjustment.
 - Alarm management.
 - Time scheduling.
 - Override function.

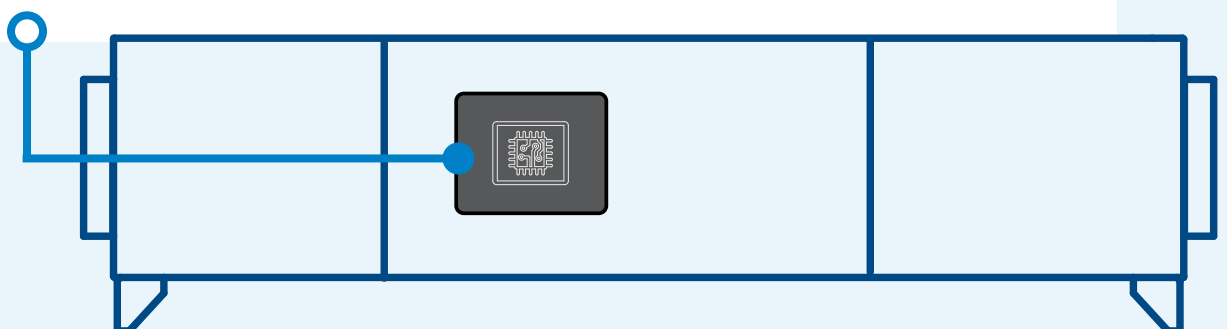

Operating modes

Efficient ventilation, versatile options

Cleva heat recovery units offer flexibility and efficiency in every mode of operation, adapting to the seasons and your preferences to create a comfortable environment.

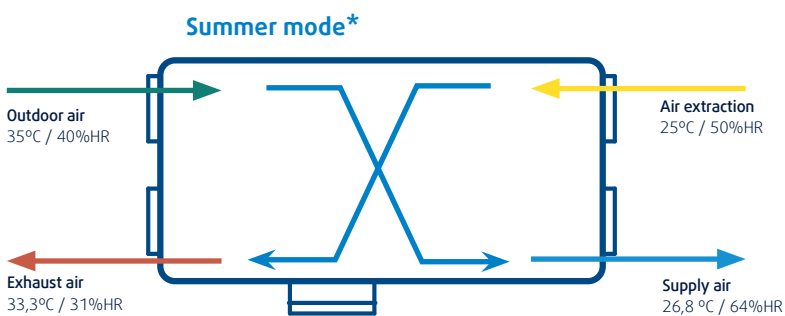
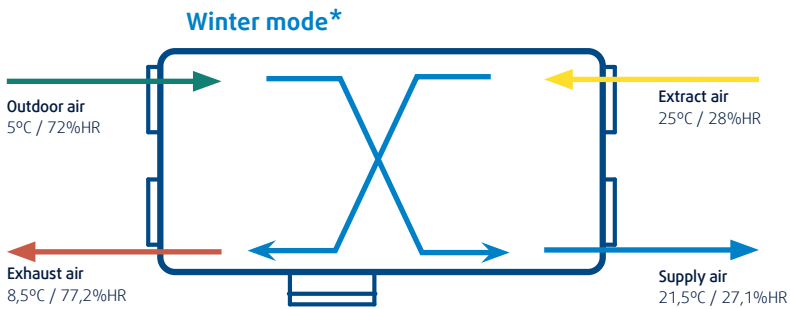

*Air conditions according to EN 308 standard.

Technical data

Unit	Flow rate nominal m ³ /h	Air filter (Supply/Exhaust) (1)	Efficiency Winter (2) [%]	Efficiency Summer (2) [%]	Electrical supply V/PH/Hz+Pe	Maximum input current (3) [A]	Maximum input power (3) [kW]
Cleva 500	500	ePM1 55% (M5) / ePM10 60% (F7)	82,6	82,4	230/1N/50+PE	3,3	0,59
Cleva 1000	1000	ePM1 55% (M5) / ePM10 60% (F7)	80,8	80,5	230/1N/50+PE	4,9	1,25
Cleva 1500	1500	ePM1 55% (M5) / ePM10 60% (F7)	79,0	78,8	230/1N/50+PE	4,9	1,25
Cleva 2000	2000	ePM1 55% (M5) / ePM10 60% (F7)	79,1	78,9	230/1N/50+PE	7,5	1,85
Cleva 3000	3000	ePM1 55% (M5) / ePM10 60% (F7)	82,4	82,2	400/3N/50+PE	5,1	3,25
Cleva 4000	4000	ePM1 55% (M5) / ePM10 60% (F7)	82,4	82,1	400/3N/50+PE	9,1	5,75

Notes:

- Filters not included as standard. Filtration classes according to ISO 16890.
- Conditions:
Outdoor air: 5°C – 72% RH. Extract air: 25°C – 28% RH.
Outdoor air: 35°C – 40% RH. Extract air: 25°C – 50% RH.
- Power consumption without optional components.

Dimensions

Cleva overall dimensions*						
Unit	High [mm]	Width [mm]	Length [mm]	Weight [kg]	Duct connections diameter [mm]	Drain connection [inches]
Cleva 500	340	630	1500	93	250	1/2"-M
Cleva 1000	460	890	1700	162	315	1/2"-M
Cleva 1500	460	960	2050	201	350	1/2"-M
Cleva 2000	460	1270	2150	251	350	1/2"-M
Cleva 3000	599	1450	2500	364	450	1/2"-M
Cleva 4000	599	1890	2500	446	450	1/2"-M

*Without optionals

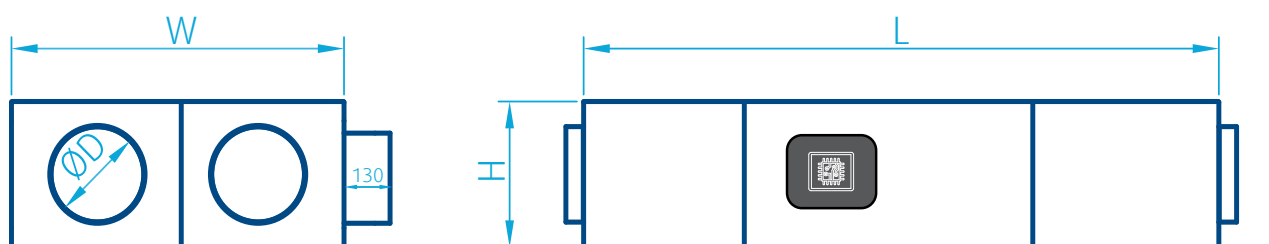

Sound levels

Unit	63 Hz [dB]	125 Hz [dB]	250 Hz [dB]	500 Hz [dB]	1 kHz [dB]	2 kHz [dB]	4 kHz [dB]	8 kHz [dB]	Sound power level free discharge [dBA]	Radiated sound power [dBA]
Cleva 500	72	75	69	71	68	68	64	63	74	57
Cleva 1000	74	77	73	74	72	69	65	60	77	60
Cleva 1500	81	80	76	78	77	75	71	70	82	64
Cleva 2000	82	81	80	74	74	73	71	65	80	66
Cleva 3000	70	69	72	72	78	76	78	71	83	61
Cleva 4000	68	70	77	75	80	80	80	75	86	64

Notes:

1.- Data obtained with nominal flow rate and density 1.2 kg/m³. Air filters ePM10 70% (M6) in extraction and ePM1 55% (F7) in supply and available pressure of 75 Pa in both air flows.

2.- Sound power level data for the unit's four air connections is available in the technical datasheets provided by our selection software.

Fan curves

Cleva 500

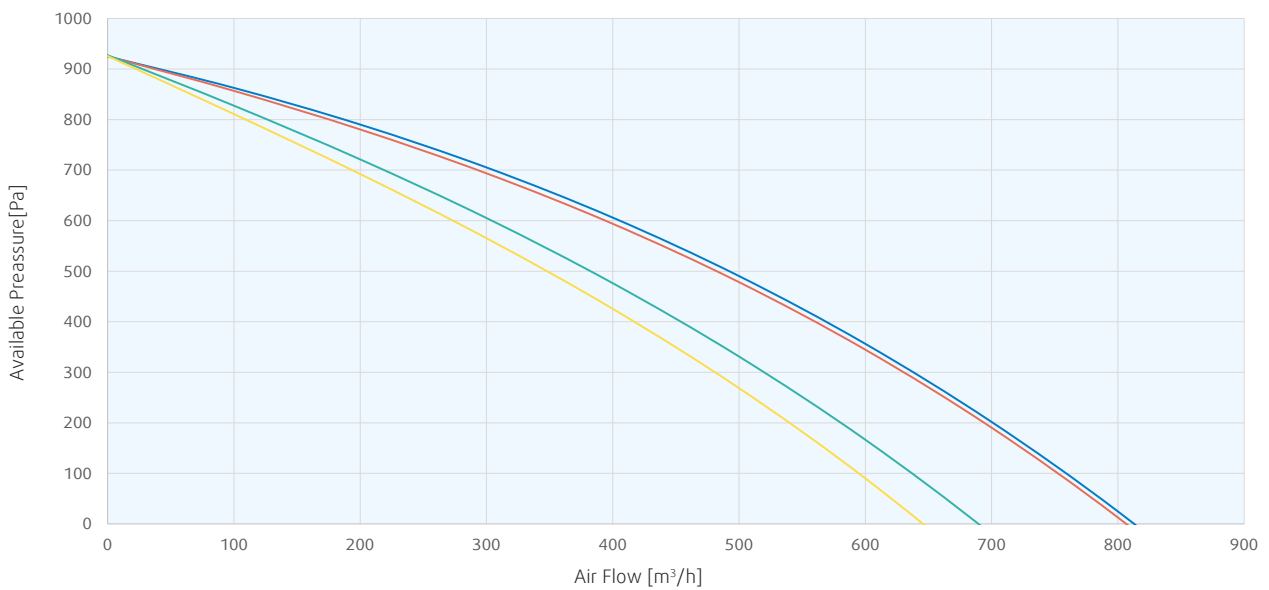

Cleva 1000

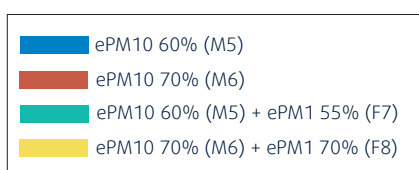
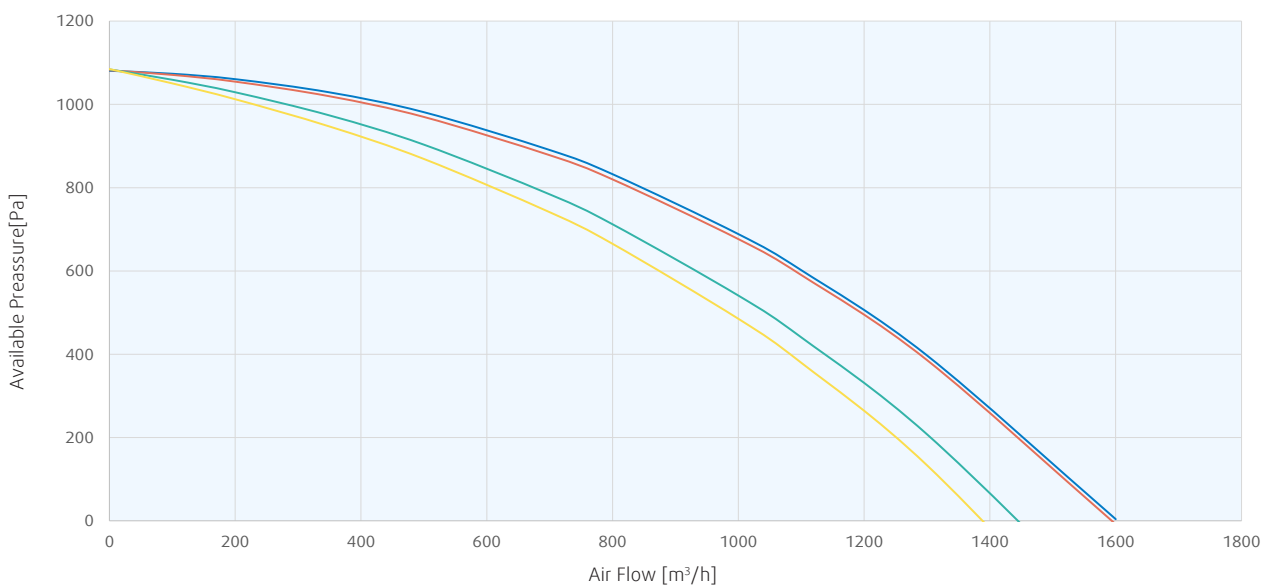

Cleva 1500

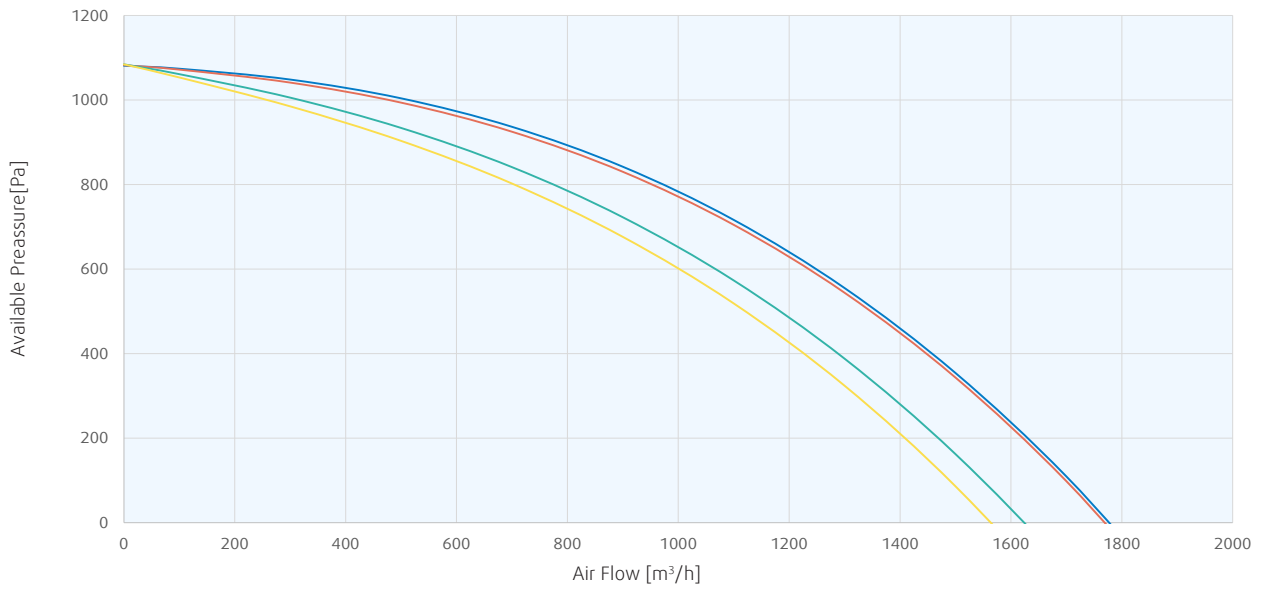

Cleva 2000

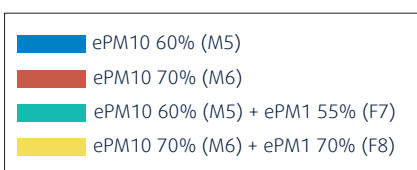
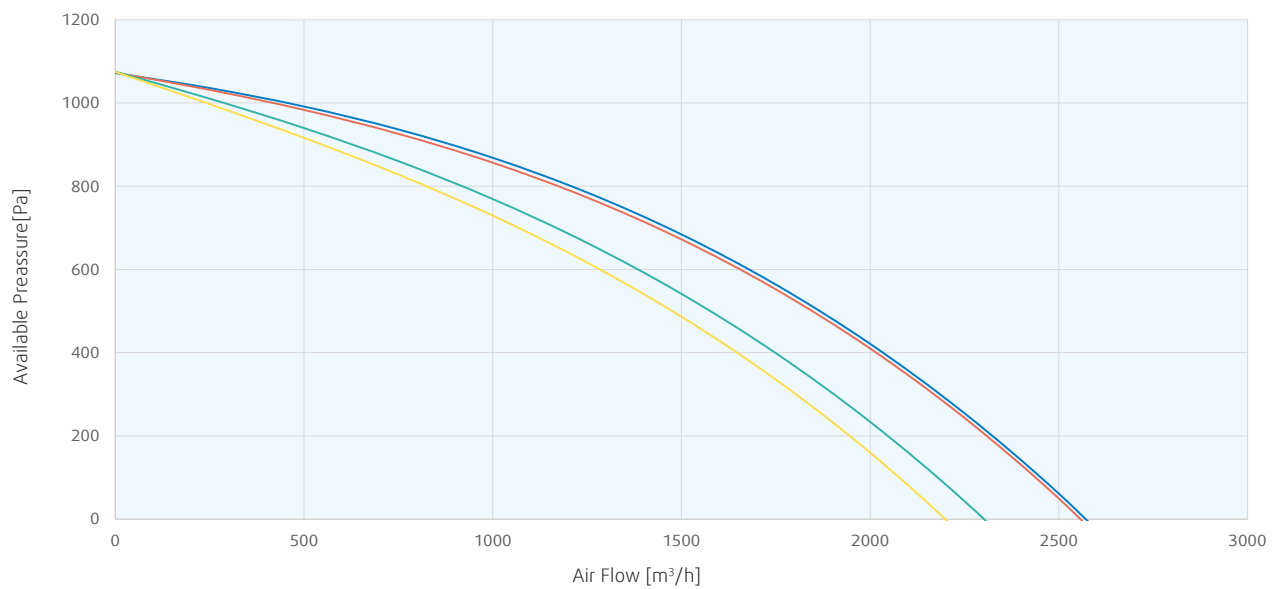

Cleva 3000

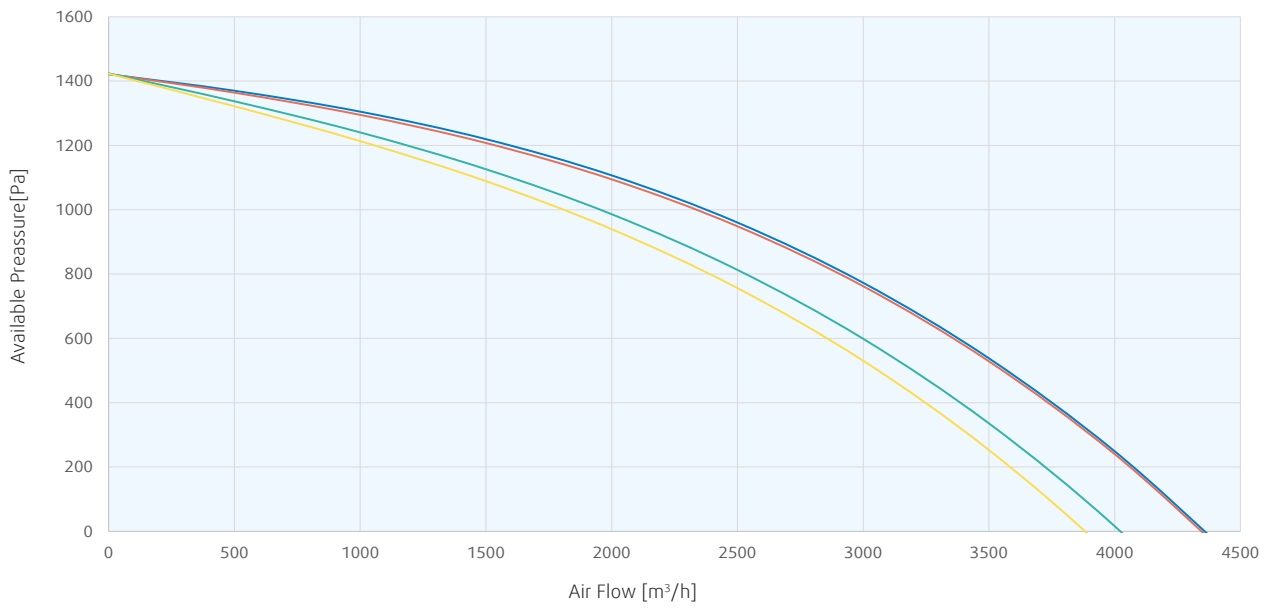

Cleva 4000

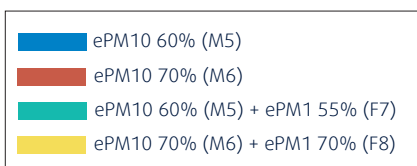
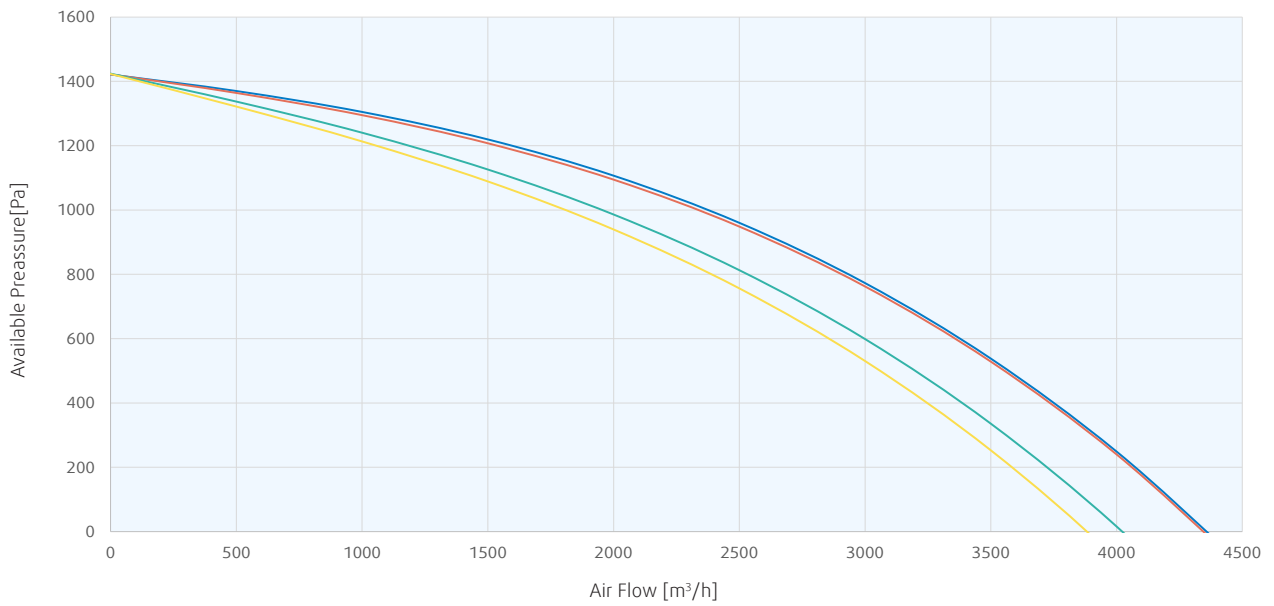

Systemair España
Calle Montecarlo 14
Fuenlabrada, Madrid
28942

Tel. +34 916 00 29 00
info@systemair.es



www.systemair.com/es-es/