

CAD/CAM/CIM
SOFTWARE FOR
WOODWORKERS

Estimating, Design, Engineering, Reporting & Manufacturing
Tools to Help You Produce Extraordinary Products with Ease

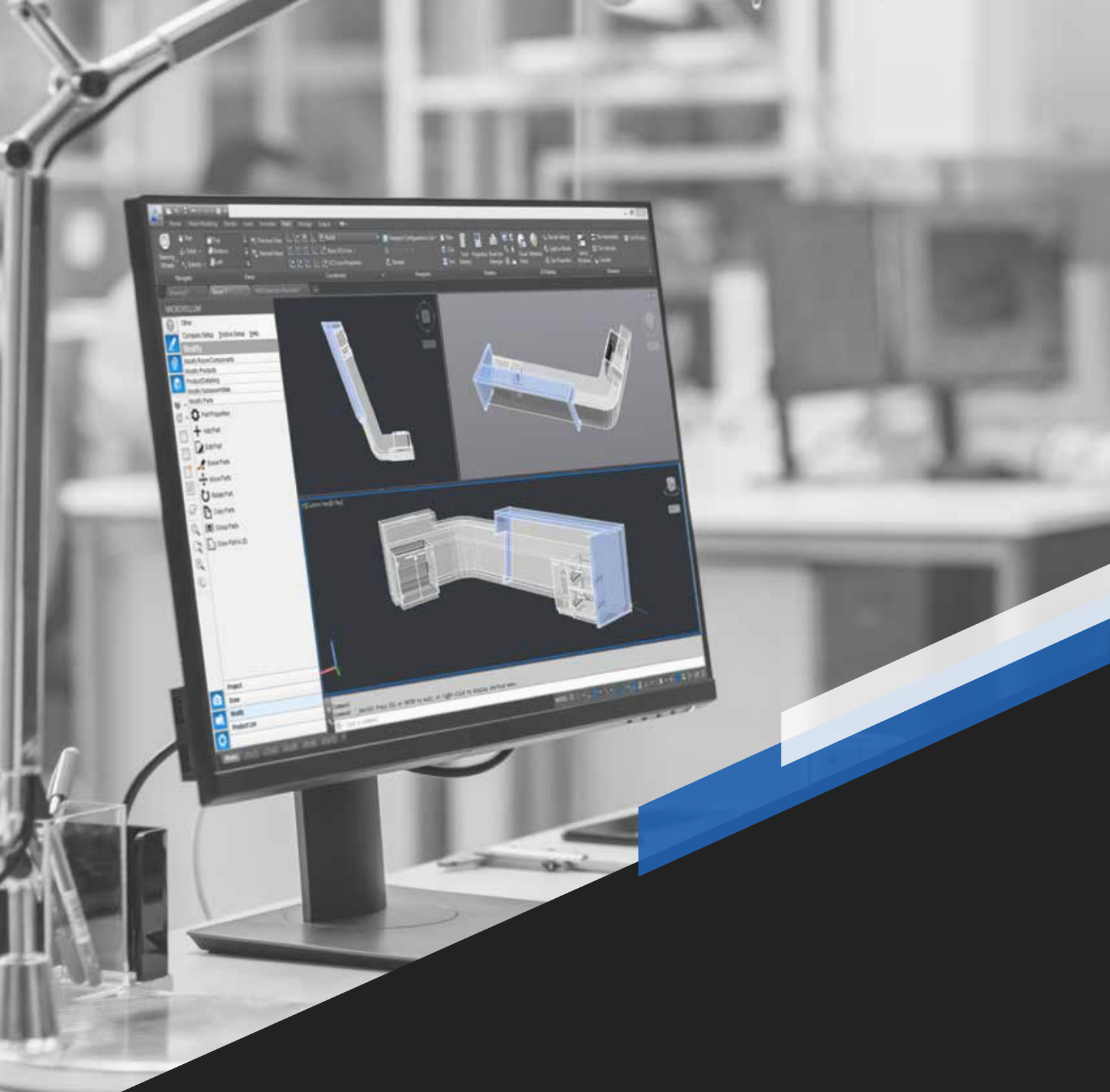

 **Microvellum**
SOFTWARE



Microvellum provides a powerful, AutoCAD-based software platform to help wood product manufacturers streamline their estimating, design, drafting, engineering and manufacturing workflows.

CONTENTS

| | |
|------------------------|----|
| OUR COMPANY | 4 |
| CORE VALUES | 5 |
| OUR PLATFORM | 6 |
| ESTIMATING | 8 |
| DESIGN & DRAFTING | 9 |
| PRODUCT LIBRARIES | 10 |
| ENGINEERING | 11 |
| REPORTS & INSIGHTS | 12 |
| MANUFACTURING | 13 |
| ROI | 14 |
| PARTNERING FOR SUCCESS | 15 |

OUR COMPANY



A FAMILY OF EXPERTS CREATING POSITIVE OUTCOMES FOR OUR CLIENTS

With best-in-class software and services.

We see a world where people are empowered with the freedom and flexibility to create extraordinary things, with ease.

We are on a mission that includes creating a software platform to streamline and standardize processes, enabling our clients to confidently scale their business.

As the needs of the industry continue to evolve, we remain focused on working with our clients to make sure they have the tools and technology to help them stay a cut above their competition.

VALUES WE STAND BEHIND

Our Core Values are our guiding principles that dictate how we operate, and how we treat each other and our clients. They are deep-rooted values harvested from the DNA of our team and we live by them every day.



BE AUTHENTIC

Our competitive nature inspires and guides us but doesn't detract from our humility.



CREATE POSITIVE OUTCOMES

Through teamwork and innovation, we engage our clients and staff to produce superior results.



ROCK SOLID SERVICE

Hard work, coupled with the determination to do the right thing, equips our clients and our team to reach their potential.



WE ARE AN AUTHENTIC TEAM THAT STRIVES TO CREATE POSITIVE
OUTCOMES THROUGH ROCK SOLID SERVICE.

OUR PLATFORM

Many woodworking businesses struggle to meet the demands of their customers. With the high cost of labor, scarcity of skilled workers, and demand for mass customization, it can be difficult to build products on time and on budget.

To respond to these needs, we developed software to help streamline the many processes related to project estimating, product design and engineering, and production so our customers can confidently bid on any project and grow their business.



ESTIMATING

Take the guesswork out of project costing, enabling you to bid your next project with confidence.

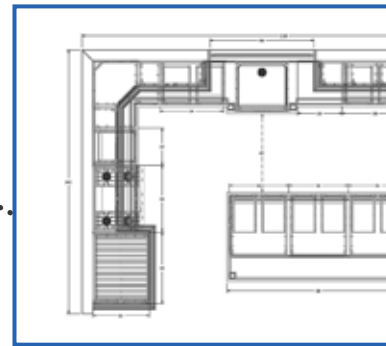

DESIGN & DRAFTING

AutoCAD-based design, drafting, detailing, 3D modeling, prototyping, rendering, collaboration and review tools.



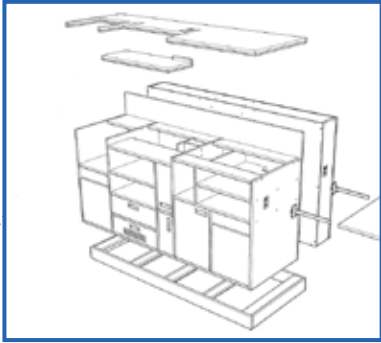

ENGINEERING

Powerful and flexible tools for parametric product planning, design, configuration and management.



REPORTS & INSIGHTS

With a built-in report engine, your reporting possibilities are endless.



CNC INTEGRATION

Want the best performance from your machinery? Our platform offers performance-tuned machine code for every CNC machine you own.



MANUFACTURING

We specialize in helping our clients streamline their manufacturing workflows with one platform to drive the entire process.

ESTIMATING



PREDICT YOUR TIME, MATERIAL & LABOR COSTS WITH CONFIDENCE

Creating project estimates can be stressful. Creating them without really knowing your true costs is even worse.

We understand and have developed estimating tools that are designed to make your life easier and enable you to bid your next project with confidence.

PUTTING YOU IN CONTROL OF YOUR DATA AND YOUR PRICING

Because you deserve a solution that is adaptable.

- Our platform allows your estimators and engineers to work from the same library dataset, enabling your team to work more efficiently with less redundancy.
- Provide your estimators with a dataset that is ready for manufacturing, reducing human error and under-bidding for custom specifications.
- Adjust material, hardware, labor and other costs at any time, per project or per product.
- Improve the accuracy of your estimates by factoring in the exact machining time, labor rates, machine cycles, drafting time and any other custom measurement or value you need.

DESIGN & DRAFTING

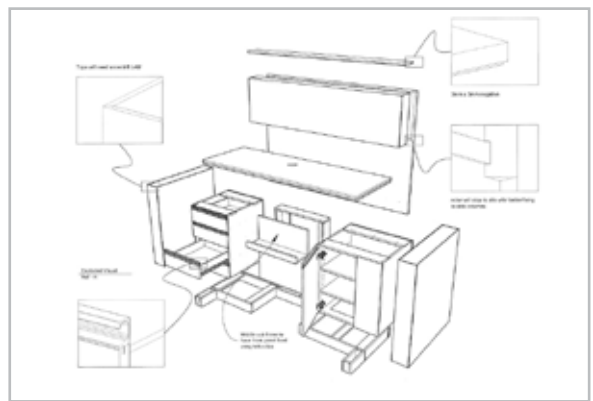
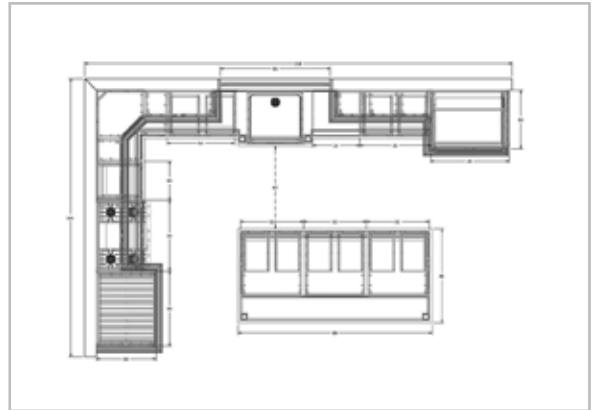

PROFESSIONAL CAD TOOLS BUILT FOR WOODWORKERS

Paired with product library data intelligence.

Creating submittal drawings, 3D models, and presentation renderings for your projects can be a tedious task, but it doesn't have to be. Our platform can help you elevate your professionalism and improve your efficiencies when it comes to designing and drafting your projects.

- Design, model, and detail your products in an AutoCAD-based engineering solution where the design contains all the information needed for manufacturing.
- Visualize the design and function of your creations using powerful 2D, 3D detailing and rendering tools.
- BIM Level 500 compatible.

PRODUCT LIBRARIES



HIGHLY CUSTOMIZABLE PRODUCTS

With endless user-definable interfaces and controls.

Our ever-expanding solution comes equipped with a customizable Foundation product library (Frameless Cabinetry). Built-in configuration options give you the freedom and flexibility to configure products that meet your exact design and engineering specification with ease.

EXPANSIONS

- Face Frame
- Office Furniture
- Closets/Wardrobes
- Store Fixtures
- Staircases
- Bathroom Partitions
- Diewalls
- Custom Products

ENGINEERING



PROFESSIONAL ENGINEERING TOOLS THAT PUT YOU IN CONTROL

With limitless engineering possibilities.

Are you feeling restricted by your current CAD software? Our platform provides flexible engineering tools that enable you to standardize custom design requests and grow beyond simple cabinetry with the power of product library data and 3D solid modeling.

- Highly customizable and extensive product libraries.
- Quick setup for custom machining and construction methods.
- Expand your capabilities with advanced 3D solid modeling and analysis for complex joinery and custom products.
- Graphical design and engineering tools to easily build custom nurses stations, bench seating, kitchen bars, hotel reception areas or other custom architectural millwork.
- Easy-to-use Excel-based logic.

REPORTS & INSIGHTS



THE RIGHT DATA, AT THE RIGHT TIME, IN THE RIGHT PLACE

With best-in-class software and services.

- Take advantage of the built-in project costing, master cut lists, buy out items, optimization & summary, face frames, work order completion, labor costs, sheet stock, edgebanding, hardware items, drawer box list and so many more.
- Our platform uses a single SQL database for all project, product, and work order information. This enables you to access information about any project to create endless report variations.
- Use the built-in Report Designer to build your own custom reports.
- Add interactivity and cut costs by going paperless with integrated tools for creating HTML and PDF reports that can be accessed by your network.

MANUFACTURING



Image courtesy of Unitech Oxon

A STREAMLINED SOLUTION FOR MANUFACTURING

For traditional woodworking and fully automated CNC production lines.

- Optimization reports for non-CNC production environments.
- Detailed cut lists and part DXF drawings.
- Assembly drawings and product detail reporting.
- Integrated CAM toolsets for single part creation.
- Automated tool pathing & program generation for CNC machinery.
- Automated part mapping to help you direct the right parts to the right machines for production.
- Scrap management system to help you reuse left over material.
- On-demand and integrated auto-labeling connectivity.
- Integrated post-processing for CNC machinery

The connections you need to streamline your production - table saw optimisation, boring machines, automated chop saws, point-to-point machining centres, flat table routers, material handling, robotic arms.

ROI

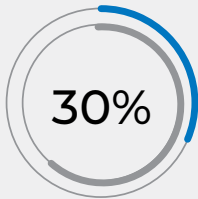
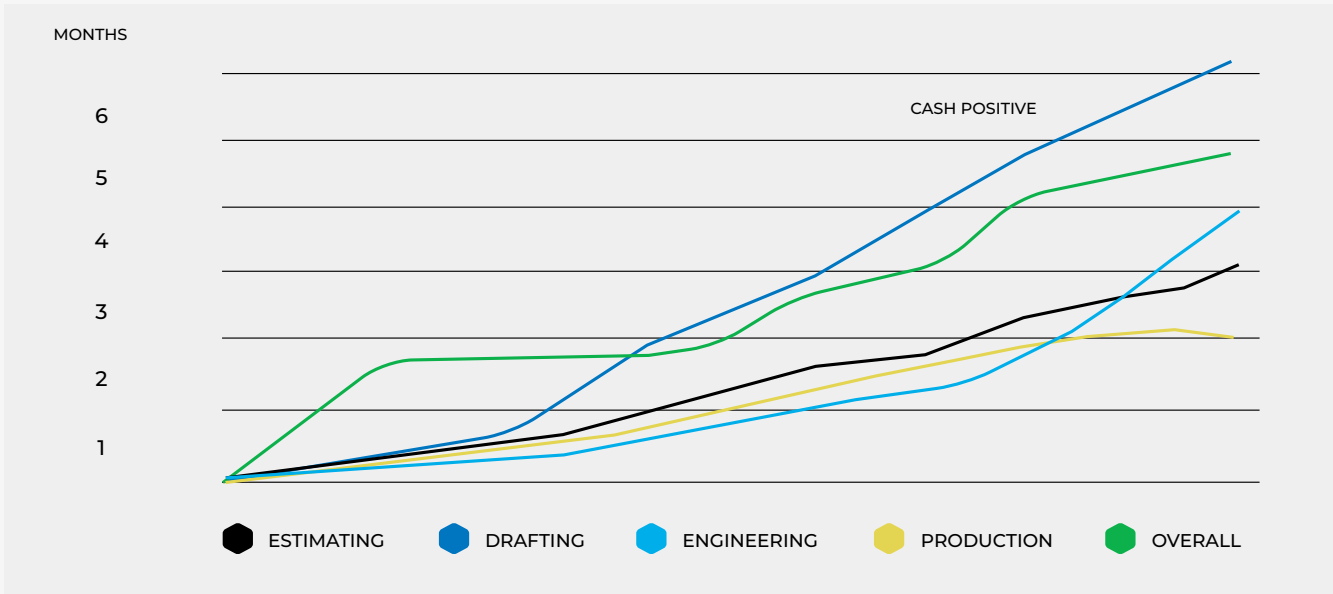

Drafting Efficiency

Reducing the time to create submittals & eliminating errors

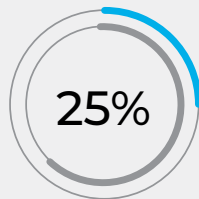

Engineering

Providing a standard solution for managing custom specifications

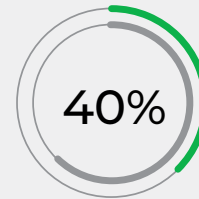

Overall

Streamlining your design to manufacturing processes

“Our clients want products designed and constructed the way they want, to their specifications. With Microvellum we can create different specs for each client, containing specific materials, hardware, and construction methods for our clients. This flexibility has helped grow our reputation and our business.”

- Unitech Oxon, LTD

“Our Microvellum software has been an instrumental component of our design and manufacturing process the past fourteen years. It is essentially an extension of AutoCAD and provides us with a seamless transition from the design and approval stage, right into to the production stage of a project.”

- Martek



PARTNERING FOR SUCCESS

Our Account Management team, supported by a diverse group of service providers and support technicians, is made up of talented individuals with a passion for helping people reach their potential. Together, we navigate complex problems to find ingenious solutions for our clients.

WE LOOK FORWARD TO HELPING
YOU STREAMLINE THE WAY YOU WORK

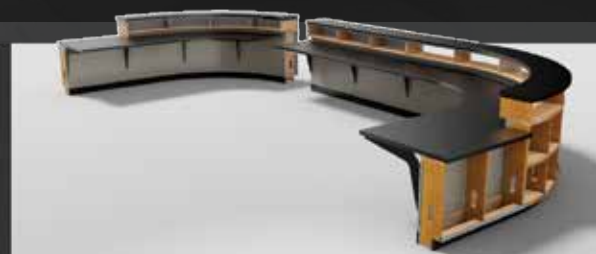
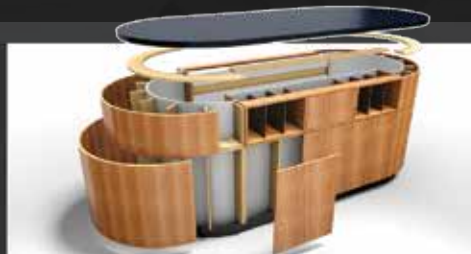

Microvellum Software

444 South Haskell Street, Central Point, Oregon USA 97502

1.800.204.0913

www.microvellum.com